

ITEM 156554 LCA-4TR-40-1060-AP-156554

| Description | Technical data | Accessories | Downloads |
|-------------|----------------|-------------|-----------|
|-------------|----------------|-------------|-----------|



Features

- › Resolution 40 mm
- › Protective field height 1,060 mm
- › Extended range 20 m
- › LED indicator for weak signal
- › With plug connector M12
- › Two safety outputs (OSSD)
- › Installation material is included with the product

Protective function



- › Figure
hand protection

LED function display



► Figure
Transmitter



► Figure
Receiver

| | |
|-----------------------|------------------|
| LED OK | Normal operation |
| LED ERROR | Fault state |
| LED STOP | Stop state |
| LED TEST | Test function |
| LED START | Start/ restart |
| LED SIGNAL LOW | Weak signal |

Pin assignment transmitter

| Plug connector (view of connection side) | Pin | Designation | Function | Conductor coloring of connection cable |
|--|-----|-------------|---|---|
| | 1 | 24 V DC | Operating voltage, 24 V DC | BN |
| | 2 | RANGE 0 | Device configuration, corresponds to the standard EN 61131-2 | WH |
| | 3 | 0 V DC | Operating voltage, 0 V DC | BU |
| | 4 | RANGE 1 | Device configuration, corresponds to the standard EN 61131-2 | BK |
| | 5 | FE | Function earth (must be connected to meet the EMC requirements) | GY |

Connector assignment receiver

| Plug connector (view of connection side) | Pin | Designation | Function | Conductor coloring of connection cable |
|---|-----|---------------|--|---|
|  | 1 | FO1A | Safety output, channel 1 | WH |
| | 2 | 24 V DC | Operating voltage, 24 V DC | BN |
| | 3 | FO1B | Safety output, channel 2 | GN |
| | 4 | K1_K2/RESTART | Feedback external contactors | YE |
| | 5 | SEL_A | Device configuration | GY |
| | 6 | SEL_B | Device configuration | PK |
| | 7 | 0 V DC | Operating voltage, 0 V DC | BU |
| | 8 | FE | Function earth (must be connected to meet the EMC requirements) | RD |

Approvals



Mechanical values and environment

| | |
|-------------------------------------|---|
| Number of safety outputs | 2 Static, self-monitoring PNP safety outputs ^[1] |
| Resolution | 40 mm |
| Height of the protective field | 1060 mm |
| Height of the sensor | 1113 mm |
| Maximum length of connection cables | 100 m |
| Range of the protective field | 20000 mm |
| Dimensions | 28x30 mm ^[2] |
| Ambient temperature | -30 ... 55 °C |
| Degree of protection | IP 65 / IP 67 |
| Installation position | Any ^[3] |
| Reaction time | 6,5 ms |
| Connection | Plug connector M12 (5-pin transmitter / 8-pin receiver) |

Electrical connection ratings

| | |
|------------|----|
| Cascadable | No |
|------------|----|

| | |
|----------------------|---|
| Muting possible | In combination with external sensors and an evaluation unit |
| Operating voltage DC | 24 V DC -20% ... +20% |
| Current consumption | 400 mA |
| Power consumption | |
| | Transmitter 1 W |
| | Receiver 2 W |
| LED indicator | Yes [4] |

Reliability values acc. to EN ISO 13849-1

| | |
|------------------------|----------------------------|
| ESPE type | 4 [5] |
| Performance Level | PL e [6] |
| PFH _D | 1,35x10 ⁻⁸ |
| Safety Integrity Level | SIL 3 / SILCL 3 [7] |
| Mission time | 20 y |

[1] With short circuit and overload protection

[2] In cross-section

[3] Optional: adjustable holders

[4] Self-diagnostics and status

[5] Acc. to EN 61496-1

[6] acc. to EN ISO 13849-1

[7] According to IEC 61508-1...4 / IEC 62061

Dimension drawing

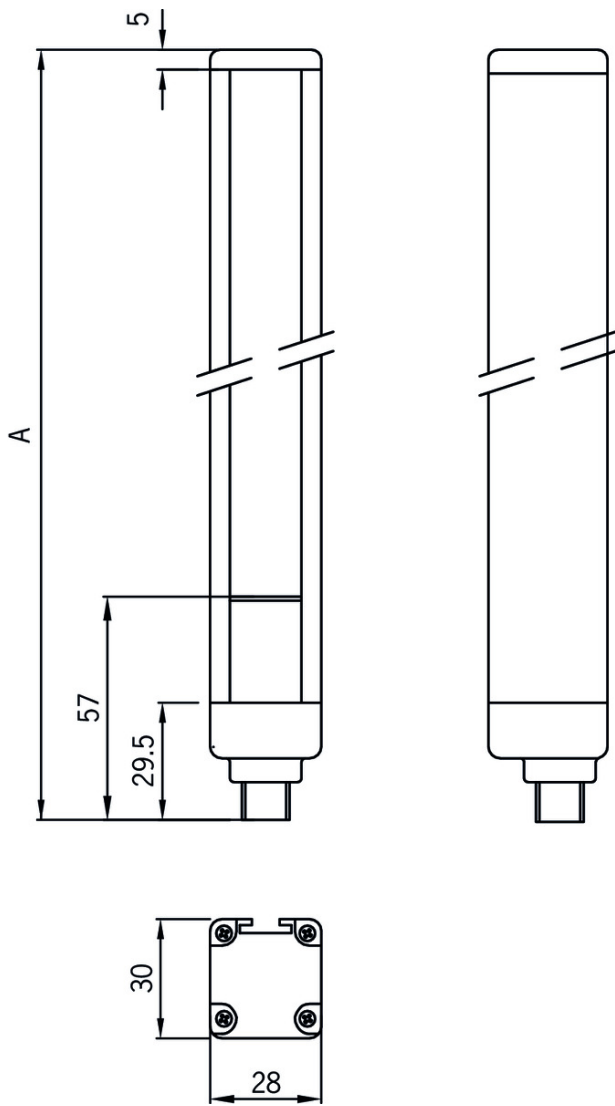

Legende

A = Height of the sensor (see technical data)

Wiring diagram receiver

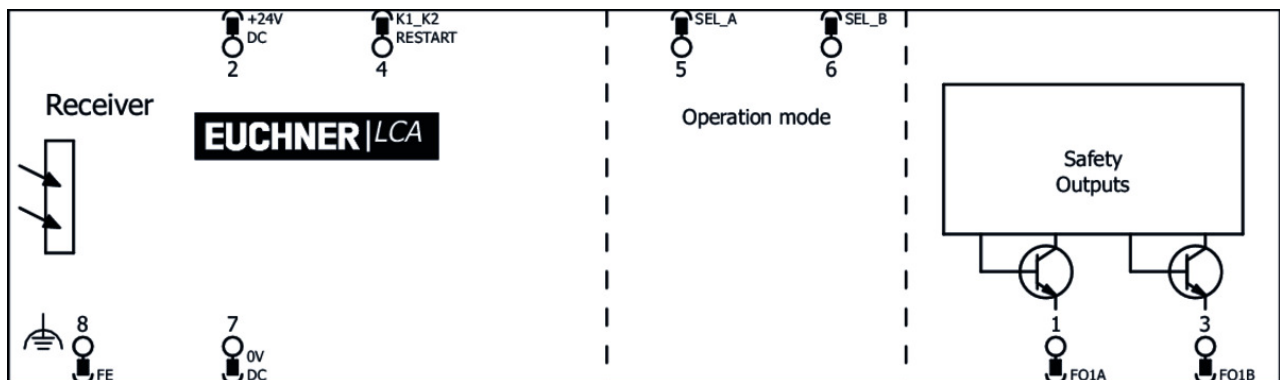

Wiring diagram transmitter



Mounting accessories

- ✓ Socket for mounting pillars 202 x 224 x 55 mm



156884 AM-OS-P-AA-156884

✓ Features

- › Socket for mounting pillars
- › Spring-mounted floor plate made of steel
- › Improved compensation of unevenness
- › Adjustable via adjusting screws
- › Height 55 mm

- ✓ Socket for mounting pillars 202 x 224 x 34 mm



156885 AM-OS-P-AB-156885

✓ Features

- › Socket for mounting pillars
- › Adjustable via adjusting screws
- › Height 34 mm

- ✓ Mounting pillar for protective field heights from 760 - 1060 mm or 3 - 4 beam light grids



156887 AM-OS-C-A1-1200-156887

✓ Features

- › Mounting pillar for light grids and light curtains LCA
- › For protective field heights from 760 - 1060 mm or 3 - 4 beams
- › Protects against damage
- › Straightforward adjustment using spherical circular level in the cover

- ✓ Mounting pillar with cable gland for protective field heights from 760 - 1060 mm or 3 - 4 beam light grids



156891 AM-OS-C-A1-M-1200-156891

✓ Features

- › Mounting pillar for light grids and light curtains LCA
 - › For protective field heights from 760 - 1060 mm or for 3 - 4 beams
 - › With integrated cable gland PG11
 - › Protects against damage
 - › Straightforward adjustment using spherical circular level in the cover
-

- ▼ 8 x vibration damper for protective field heights from 310 - 1,060 mm



156917 AM-OS-D-V08-156917

▼ Features

- › Vibration damper for light grids and light curtains LCA
 - › For protective field heights 310 - 1060 mm
 - › Packaging unit 8 pcs.
 - › For reducing vibration
 - › Protects against damage
 - › Installation either on the product or on mounting pillar
-

- ▼ 4 x adjustable holder



156919 AM-OS-B-A1-V04-156919

▼ Features

- › Set of 4 holders for light grids and light curtains LCA
 - › For protective field heights up to 1210 mm
 - › Adjustable horizontally / vertically
 - › Quick mount using two screws
 - › Can be mounted directly on LCA
-

- ▼ 4 x adjustable holder 180°



156921 AM-OS-B-A2-V04-156921

▼ Features

- › Set of 4 holders for light grids and light curtains LCA
 - › Can be rotated by 180°
 - › Adjustable horizontally / vertically
 - › Quick mount using two screws
 - › Can be mounted directly on LCA
-

Function expansion

- ▼ Mounting pillar with deflection mirror for protective field heights from 1060 to 1360 mm



156897 AE-OS-SC-1670-156897

▼ Features

- › Mounting pillar with deflection mirror for light grids and light curtains LCA
 - › For protective field heights from 1060 to 1360 mm
 - › Protects against damage
 - › Straightforward adjustment using spherical circular level in the cover
-

- ▼ Deflection mirror for protective field height 1060 mm or 4 beam light grids

156909 AE-OS-S-1060-156909



- ✓ Features
 - › Deflection mirror with adjustable holder for light grids and light curtains LCA
 - › For protective field height 1060 mm or 4 beams
-

Miscellaneous accessories

- ✓ Laser alignment aid



156915 AY-OS-LSR-156915

- ✓ Features
 - › Laser alignment aid for light grids and light curtains LCA
 - › Light source: Laser diode – wavelength 650 nm
 - › Laser class 2
 - › Usable range 100 m
 - › Straightforward clamping on the transmitter
-

- ✓ Test rod Ø 40 mm



156924 AY-OS-FTR-40-156924

- ✓ Features
 - › Test rod for light curtains LCA
 - › Used for function test
 - › Ø 40 mm
 - › Cylinder with matt surface
-

Connection material

- ✓ Connection cable with straight plug connector M12, 5-pin, 5m



100183 C-M12F05-05X034PV05,0-MA-100183

- ✓ Features
 - › M12 female plug, 5-pin
 - › Straight plug connector
 - › PVC cable
 - › Cable length 5 m
 - › With flying lead
-



113620 C-M12F05-05X034PU05,0-MA-113620

- ✓ Features
 - › M12 female plug, 5-pin
 - › Straight plug connector
 - › PUR cable
 - › Cable length 5 m
 - › With flying lead
-

- ✓ Connection cable with plug connector M12, 5-pin, 10m



100184 C-M12F05-05X034PV10,0-MA-100184

- ✓ Features

- › M12 female plug, 5-pin
 - › Straight plug connector
 - › PVC cable
 - › Cable length 10 m
 - › With flying lead
-

▼ Connection cable with plug connector M12, 5-pin, 20m



100185 C-M12F05-05X034PV20,0-MA-100185

▼ Features

- › M12 female plug, 5-pin
 - › Straight plug connector
 - › PVC cable
 - › Cable length 20 m
 - › With flying lead
-

▼ Connection cable with straight plug connector M12, 5-pin, 10m



113640 C-M12F05-05X034PU10,0-MA-113640

▼ Features

- › M12 female plug, 5-pin
 - › Straight plug connector
 - › PUR cable
 - › Cable length 10 m
 - › With flying lead
-

▼ Connection cable with straight plug connector M12, 5-pin, 20 m



113682 C-M12F05-05X034PU20,0-MA-113682

▼ Features

- › M12 female plug, 5-pin
 - › Straight plug connector
 - › PUR cable
 - › Cable length 20 m
 - › With flying lead
-

▼ Connection cable with straight plug connector M12, 5-pin, 30 m



122784 C-M12F05-05X034PU30,0-MA-122784

▼ Features

- › M12 female plug, 5-pin
 - › Straight plug connector
 - › PUR cable
 - › Cable length 30 m
 - › With flying lead
-

▼ Connection cable with 2 plug connectors M12, 5-pin, 5m



100180 C-M12F05-05X034PV05,0-M12M05-100180

▼ Features

- › M12 female plug to M12 plug connector, 5-pin
- › Straight female plug and plug connector

- › PVC cable
- › Cable length 5 m



119932 C-M12F05-05X034PU05,0-M12M05-119932

▣ Features

- › M12 female plug to M12 plug connector, 5-pin
- › Straight female plug and plug connector
- › PUR cable
- › Cable length 5 m

▣ Connection cable with 2 plug connectors M12, 5-pin, 10m



100181 C-M12F05-05X034PV10,0-M12M05-100181

▣ Features

- › M12 female plug to M12 plug connector, 5-pin
- › Straight female plug and plug connector
- › PVC cable
- › Cable length 10 m



119947 C-M12F05-05X034PU10,0-M12M05-119947

▣ Features

- › M12 female plug to M12 plug connector, 5-pin
- › Straight female plug and plug connector
- › PUR cable
- › Cable length 10 m

▣ Connection cable with 2 plug connectors M12, 5-pin, 20m



100182 C-M12F05-05X034PV20,0-M12M05-100182

▣ Features

- › M12 female plug to M12 plug connector, 5-pin
- › Straight female plug and plug connector
- › PVC cable
- › Cable length 20 m



119971 C-M12F05-05X034PU20,0-M12M05-119971

▣ Features

- › M12 female plug to M12 plug connector, 5-pin
- › Straight female plug and plug connector
- › PUR cable
- › Cable length 20 m

▣ Connection cable with plug connector M12, 8-pin, 5m



100177 C-M12F08-08X025PV05,0-MA-100177

▣ Features

- › M12 female plug, 8-pin
- › Straight plug connector
- › PVC cable
- › Cable length 5 m
- › With flying lead



115112 C-M12F08-08X025PU05,0-MA-115112

▼ Features

- › M12 female plug, 8-pin
- › Straight plug connector
- › PUR cable
- › Cable length 5 m
- › With flying lead

▼ Connection cable with plug connector M12, 8-pin, 10m



100178 C-M12F08-08X025PV10,0-MA-100178

▼ Features

- › M12 female plug, 8-pin
- › Straight plug connector
- › PVC cable
- › Cable length 10 m
- › With flying lead



115113 C-M12F08-08X025PU10,0-MA-115113

▼ Features

- › M12 female plug, 8-pin
- › Straight plug connector
- › PUR cable
- › Cable length 10 m
- › With flying lead

▼ Connection cable with plug connector M12, 8-pin, 20m



100179 C-M12F08-08X025PV20,0-MA-100179

▼ Features

- › M12 female plug, 8-pin
- › Straight plug connector
- › PVC cable
- › Cable length 20 m
- › With flying lead



115114 C-M12F08-08X025PU20,0-MA-115114

▼ Features

- › M12 female plug, 8-pin
- › Straight plug connector
- › PUR cable
- › Cable length 20 m
- › With flying lead

▼ Connection cable with plug connector M12, 8-pin, 30m



115116 C-M12F08-08X025PV30,0-MA-115116

▼ Features

- › M12 female plug, 8-pin
- › Straight plug connector
- › PVC cable
- › Cable length 30 m

- › With flying lead



115257 C-M12F08-08X025PU30,0-MA-115257

▼ Features

- › M12 female plug, 8-pin
- › Straight plug connector
- › PUR cable
- › Cable length 30 m
- › With flying lead

- ▼ Connection cable with 2 plug connectors M12, 1m



123430 C-M12M08-08X025PV01,0-M12F08-123430

▼ Features

- › 8-pin M12 male plug, straight
- › 8-pin M12 female connector, straight
- › PVC cable
- › Cable length 1m

- ▼ Connection cable with 2 plug connectors M12, 2m



123431 C-M12M08-08X025PV02,0-M12F08-123431

▼ Features

- › 8-pin M12 male plug, straight
- › 8-pin M12 female connector, straight
- › PVC cable
- › Cable length 2m

- ▼ Connection cable with 2 plug connectors M12, 5m



123432 C-M12M08-08X025PV05,0-M12F08-123432

▼ Features

- › 8-pin M12 male plug, straight
- › 8-pin M12 female connector, straight
- › PVC cable
- › Cable length 5m

- ▼ Connection cable with 2 plug connectors M12, 10m



123433 C-M12M08-08X025PV10,0-M12F08-123433

▼ Features









- › 8-pin M12 male plug, straight
- › 8-pin M12 female connector, straight
- › PVC cable
- › Cable length 10m

Manual de instrucciones Barreras/cortinas fotoeléctricas LCA 4

| | Doc. no. | Version | Language | Download |
|--|----------|----------|--|--|
| Betriebsanleitung Lichtgitter/ Lichtvorhänge LCA 4 Operating Instructions Light Grids/ Light Curtains LCA 4 | 2504709 | 02-02/18 |   |  5.2 MB |
| Mode d'emploi Barrières photoélectriques / rideaux lumineux LCA 4 | 2504709 | 02-02/18 |  |  3.1 MB |
| Manual de instrucciones Barreras/cortinas fotoeléctricas LCA 4 | 2504709 | 02-02/18 |  |  3.1 MB |







Catalogs

Light grids and light curtains LCA Barreras fotoeléctricas y cortinas fotoeléctricas LCA Barrières photoélectriques et rideaux lumineux LCA Lichtgitter und Lichtvorhänge LCA

| | Doc. no. | Version | Language | Download |
|---|----------|----------|--|---|
| Lichtgitter und Lichtvorhänge LCA | 157084 | 03-03/18 |  |  2.5 MB |
| Barrières photoélectriques et rideaux lumineux LCA | 157086 | 03-03/18 |  |  2.5 MB |
| Barreras fotoeléctricas y cortinas fotoeléctricas LCA | 157087 | 03-03/18 |  |  2.5 MB |
| Light grids and light curtains LCA | 157085 | 03-03/18 |  |  2.5 MB |

Declaration of conformity

EU-Konformitätserklärung

| | Doc. no. | Version | Language | Download |
|--|----------|----------|---|--|
| EU-Konformitätserklärung Declaración UE de conformidad Déclaration UE de conformité Dichiarazione di conformità EU declaration of conformity | 2503625 | 02-08/17 |      |  0.2 MB |