

**ITEM 156598 LCA-4TR-M-30-310-AP-156598**

Description	Technical data	Accessories	Downloads
-------------	----------------	-------------	-----------



**Features**

- › Light curtain master
- › For cascading (series connection)
- › Resolution 30 mm
- › Protective field height 310 mm
- › Range 12 m
- › With plug connector M12
- › Two safety outputs (OSSD)
- › Installation material is included with the product

**Protective function**



- › Figure  
hand protection

## Cascading (series connection)

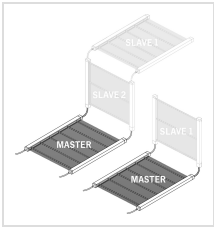

› Figure

Following combinations are possible:

**Variante A:** Master-slave 2-slave 1

**Variante B:** Master-slave 1

## LED function display



› Figure

Transmitter



› Figure

Receiver

**LED OK** Normal operation

**LED ERROR** Faults

**LED STOP** Stop

**LED TEST** Test function

**LED START** Start/ restart

## Pin assignment transmitter

Plug connector (view of connection side)	Pin	Designation	Function	Conductor coloring of connection cable
	1	24 V DC	Operating voltage, 24 V DC	BN
	2	RANGE 0	Device configuration, corresponds to the standard EN 61131-2	WH
	3	0 V DC	Operating voltage, 0 V DC	BU

Plug connector (view of connection side)	Pin	Designation	Function	Conductor coloring of connection cable
	4	RANGE 1	Device configuration, corresponds to the standard EN 61131-2	BK
	5	FE	Function earth (must be connected to meet the EMC requirements)	GY

### Connector assignment receiver

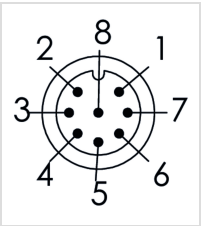
Plug connector (view of connection side)	Pin	Designation	Function	Conductor coloring of connection cable
	1	FO1A	Safety output, channel 1	WH
	2	24 V DC	Operating voltage, 24 V DC	BN
	3	FO1B	Safety output, channel 2	GN
	4	K1_K2/RESTART	Feedback external contactors	YE
	5	SEL_A	Device configuration	GY
	6	SEL_B	Device configuration	PK
	7	0 V DC	Operating voltage, 0 V DC	BU
	8	FE	Function earth (must be connected to meet the EMC requirements)	RD

### Approvals



### Mechanical values and environment

Number of safety outputs	2 Static, self-monitoring PNP safety outputs [1]
Resolution	30 mm
Height of the protective field	310 mm
Height of the sensor	386 mm

Maximum length of connection cables	100 m
Range of the protective field	12000 mm
Dimensions	28x30 mm [2]
Ambient temperature	-30 ... 55 °C
Degree of protection	IP 65 / IP 67
Installation position	Any [3]
Connection	Plug connector M12 (5-pin transmitter / 8-pin receiver) [4]

### Electrical connection ratings

Cascadable	Yes [5]
Muting possible	In combination with external sensors and an evaluation unit
Operating voltage DC	24 V DC -20% ... +20%
Current consumption	400 mA
Power consumption	
Transmitter	1 W
Receiver	2 W
LED indicator	Yes [6]

### Reliability values acc. to EN ISO 13849-1

ESPE type	4 [7]
Performance Level	PL e [8]
PFHD	$9,52 \times 10^{-9}$
Safety Integrity Level	SIL 3 / SILCL 3 [9]
Mission time	20 y

[1] With short circuit and overload protection

[2] In cross-section

[3] Optional: adjustable holders

[4] Master-slave1 and master-slave2-slave1 connections are 2x M12 5-pin

[5] Max. 50m connection cable between master and slaves

[6] Self-diagnostics and status

[7] Acc. to EN 61496-1

[8] acc. to EN ISO 13849-1

[9] According to IEC 61508-1...4 / IEC 62061

## Dimension drawing

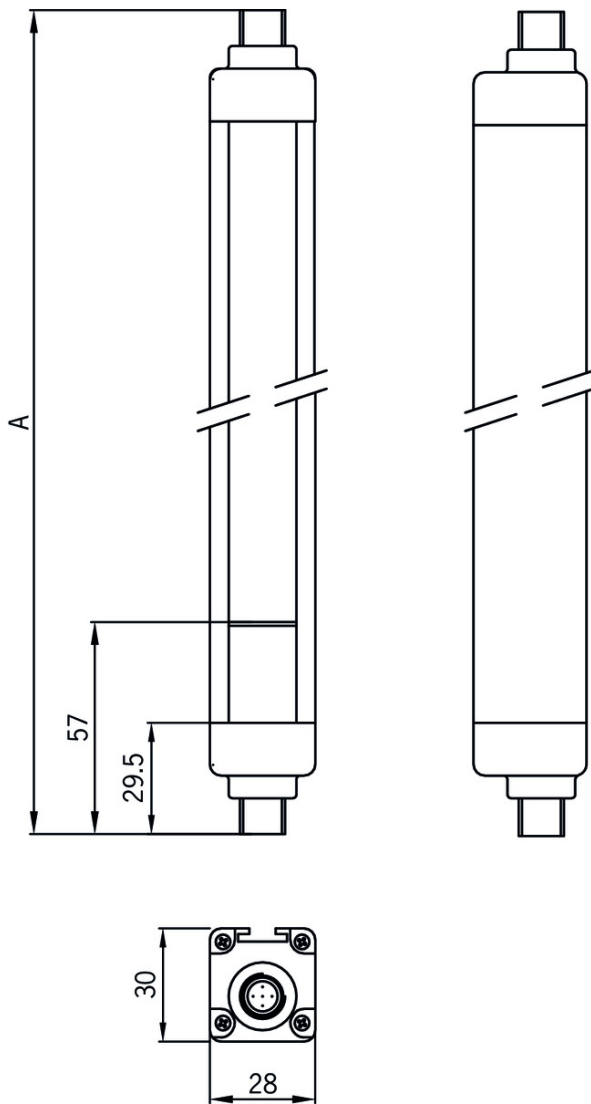

## Legende

A = Height of the sensor (see technical data)

## Wiring diagram transmitter

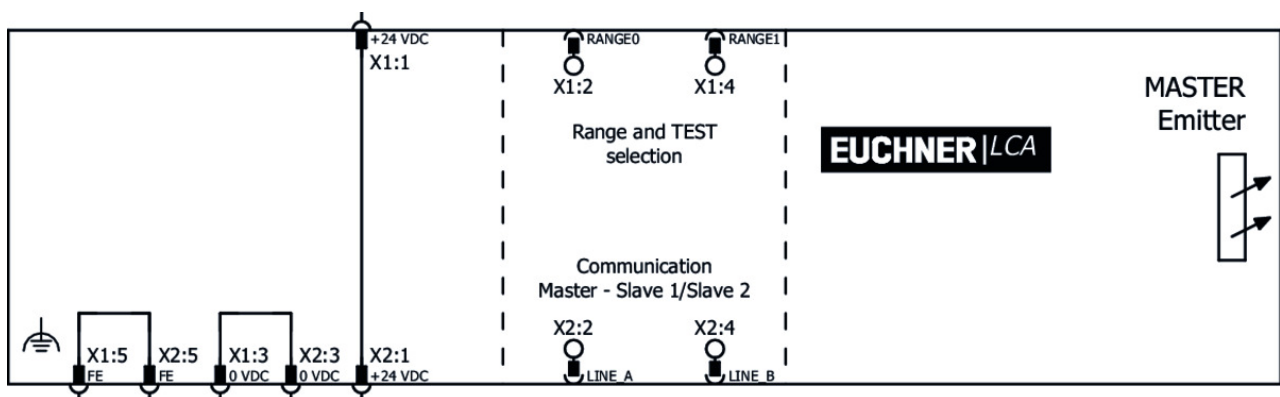

## Wiring diagram receiver

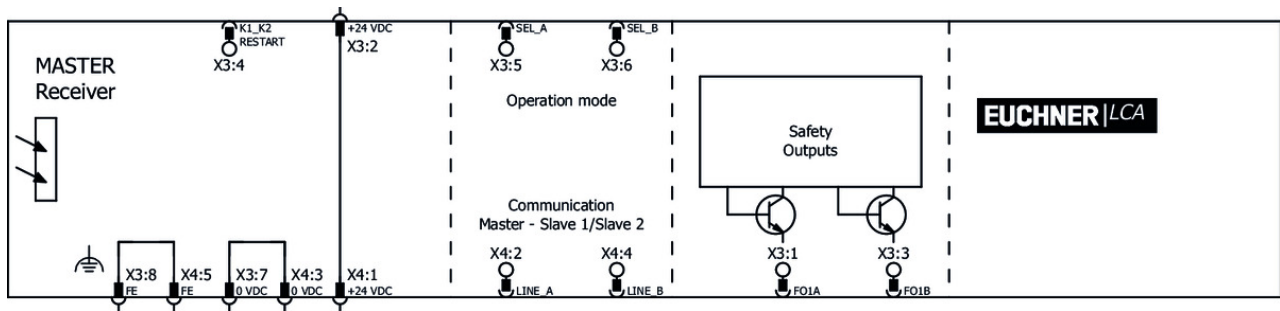

## Mounting accessories

- ✓ Socket for mounting pillars 202 x 224 x 55 mm



**156884** AM-OS-P-AA-156884

✓ Features

- › Socket for mounting pillars
- › Spring-mounted floor plate made of steel
- › Improved compensation of unevenness
- › Adjustable via adjusting screws
- › Height 55 mm

- ✓ Socket for mounting pillars 202 x 224 x 34 mm



**156885** AM-OS-P-AB-156885

✓ Features

- › Socket for mounting pillars
- › Adjustable via adjusting screws
- › Height 34 mm

- ✓ Mounting pillar for protective field heights from 160 - 610 mm or 2 beam light grids



**156886** AM-OS-C-A1-1000-156886

✓ Features

- › Mounting pillar for light grids and light curtains LCA
- › For protective field heights from 160 - 610 mm or for 2 beams
- › Protects against damage
- › Straightforward adjustment using spherical circular level in the cover

- ✓ Mounting pillar with cable gland for protective field heights from 160 - 610 mm or for 2 beam light grids



**156890** AM-OS-C-A1-M-1000-156890

✓ Features

- › Mounting pillar for light grids and light curtains LCA
- › For protective field heights from 160 - 610 mm or for 2 beams
- › With integrated cable gland PG11
- › Protects against damage
- › Straightforward adjustment using spherical circular level in the cover

- 
- ▼ 8 x vibration damper for protective field heights from 310 - 1,060 mm



**156917** AM-OS-D-V08-156917

▼ Features

- › Vibration damper for light grids and light curtains LCA
- › For protective field heights 310 - 1060 mm
- › Packaging unit 8 pcs.
- › For reducing vibration
- › Protects against damage
- › Installation either on the product or on mounting pillar

- 
- ▼ 4 x adjustable holder



**156919** AM-OS-B-A1-V04-156919

▼ Features

- › Set of 4 holders for light grids and light curtains LCA
- › For protective field heights up to 1210 mm
- › Adjustable horizontally / vertically
- › Quick mount using two screws
- › Can be mounted directly on LCA

- 
- ▼ 4 x adjustable holder 180°



**156921** AM-OS-B-A2-V04-156921

▼ Features

- › Set of 4 holders for light grids and light curtains LCA
- › Can be rotated by 180°
- › Adjustable horizontally / vertically
- › Quick mount using two screws
- › Can be mounted directly on LCA

---

## Function expansion

- ▼ Mounting pillar with deflection mirror for protective field heights from 160 - 610 mm or for 2 beam light grids



**156894** AE-OS-SC-1000-156894

▼ Features

- › Mounting pillar with deflection mirror for light grids and light curtains LCA
- › For protective field heights from 160 - 610 mm or for 2 beams
- › Protects against damage
- › Straightforward adjustment using spherical circular level in the cover

- 
- ▼ Deflection mirror for protective field height 310 mm



**156904** AE-OS-S-310-156904

▼ Features

- › Deflection mirror with adjustable holder for light curtains LCA
  - › For protective field height 310 mm
-

## Miscellaneous accessories

---

### ▾ Laser alignment aid



#### **156915** AY-OS-LSR-156915

##### ▾ Features

- › Laser alignment aid for light grids and light curtains LCA
  - › Light source: Laser diode – wavelength 650 nm
  - › Laser class 2
  - › Usable range 100 m
  - › Straightforward clamping on the transmitter
- 

### ▾ Test rod Ø 30 mm



#### **156923** AY-OS-FTR-30-156923

##### ▾ Features

- › Test rod for light curtains LCA
  - › Used for function test
  - › Ø 30 mm
  - › Cylinder with matt surface
- 

## Connection material

---

### ▾ Connection cable for cascading M12, 0.3m



#### **156926** C-M12F05-05X034PV0,30-M12F05-156926

##### ▾ Features

- › Connection cable for cascading
  - › 2 x M12 female plug, 5-pin
  - › Straight plug connector
  - › PVC cable
  - › Cable length 0.3 m
- 

### ▾ Connection cable for cascading M12, 3m



#### **156927** C-M12F05-05X034PV03,0-M12F05-156927

##### ▾ Features

- › Connection cable for cascading
  - › 2 x M12 female plug, 5-pin
  - › Straight plug connector
  - › PVC cable
  - › Cable length 3 m
- 

### ▾ Connection cable for cascading M12, 5m



#### **156928** C-M12F05-05X034PV05,0-M12F05-156928

##### ▾ Features

- › Connection cable for cascading
- › 2 x M12 female plug, 5-pin
- › Straight plug connector
- › PVC cable



- › Cable length 5 m
- 

▼ Connection cable for cascading M12, 10m



**156929** C-M12F05-05X034PV10,0-M12F05-156929

▼ Features

- › Connection cable for cascading
  - › 2 x M12 female plug, 5-pin
  - › Straight plug connector
  - › PVC cable
  - › Cable length 10 m
- 

▼ Connection cable for cascading M12, 25m



**156930** C-M12F05-05X034PV25,0-M12F05-156930

▼ Features

- › Connection cable for cascading
  - › 2 x M12 female plug, 5-pin
  - › Straight plug connector
  - › PVC cable
  - › Cable length 25 m
- 

▼ Connection cable with straight plug connector M12, 5-pin, 5m



**100183** C-M12F05-05X034PV05,0-MA-100183

▼ Features

- › M12 female plug, 5-pin
  - › Straight plug connector
  - › PVC cable
  - › Cable length 5 m
  - › With flying lead
- 



**113620** C-M12F05-05X034PU05,0-MA-113620

▼ Features

- › M12 female plug, 5-pin
  - › Straight plug connector
  - › PUR cable
  - › Cable length 5 m
  - › With flying lead
- 

▼ Connection cable with plug connector M12, 5-pin, 10m



**100184** C-M12F05-05X034PV10,0-MA-100184

▼ Features

- › M12 female plug, 5-pin
  - › Straight plug connector
  - › PVC cable
  - › Cable length 10 m
  - › With flying lead
- 

▼ Connection cable with plug connector M12, 5-pin, 20m



**100185** C-M12F05-05X034PV20,0-MA-100185

▼ Features

- › M12 female plug, 5-pin
  - › Straight plug connector
  - › PVC cable
  - › Cable length 20 m
  - › With flying lead
- 

▼ Connection cable with straight plug connector M12, 5-pin, 10m



**113640** C-M12F05-05X034PU10,0-MA-113640

▼ Features

- › M12 female plug, 5-pin
  - › Straight plug connector
  - › PUR cable
  - › Cable length 10 m
  - › With flying lead
- 

▼ Connection cable with straight plug connector M12, 5-pin, 20 m



**113682** C-M12F05-05X034PU20,0-MA-113682

▼ Features

- › M12 female plug, 5-pin
  - › Straight plug connector
  - › PUR cable
  - › Cable length 20 m
  - › With flying lead
- 

▼ Connection cable with straight plug connector M12, 5-pin, 30 m



**122784** C-M12F05-05X034PU30,0-MA-122784

▼ Features

- › M12 female plug, 5-pin
  - › Straight plug connector
  - › PUR cable
  - › Cable length 30 m
  - › With flying lead
- 

▼ Connection cable with 2 plug connectors M12, 5-pin, 5m



**100180** C-M12F05-05X034PV05,0-M12M05-100180

▼ Features

- › M12 female plug to M12 plug connector, 5-pin
  - › Straight female plug and plug connector
  - › PVC cable
  - › Cable length 5 m
- 



**119932** C-M12F05-05X034PU05,0-M12M05-119932

▼ Features

- › M12 female plug to M12 plug connector, 5-pin
- › Straight female plug and plug connector
- › PUR cable

- › Cable length 5 m
- 

▼ Connection cable with 2 plug connectors M12, 5-pin, 10m



**100181** C-M12F05-05X034PV10,0-M12M05-100181

▼ Features

- › M12 female plug to M12 plug connector, 5-pin
  - › Straight female plug and plug connector
  - › PVC cable
  - › Cable length 10 m
- 



**119947** C-M12F05-05X034PU10,0-M12M05-119947

▼ Features

- › M12 female plug to M12 plug connector, 5-pin
  - › Straight female plug and plug connector
  - › PUR cable
  - › Cable length 10 m
- 

▼ Connection cable with 2 plug connectors M12, 5-pin, 20m



**100182** C-M12F05-05X034PV20,0-M12M05-100182

▼ Features

- › M12 female plug to M12 plug connector, 5-pin
  - › Straight female plug and plug connector
  - › PVC cable
  - › Cable length 20 m
- 



**119971** C-M12F05-05X034PU20,0-M12M05-119971

▼ Features

- › M12 female plug to M12 plug connector, 5-pin
  - › Straight female plug and plug connector
  - › PUR cable
  - › Cable length 20 m
- 

▼ Connection cable with plug connector M12, 8-pin, 5m



**100177** C-M12F08-08X025PV05,0-MA-100177

▼ Features

- › M12 female plug, 8-pin
  - › Straight plug connector
  - › PVC cable
  - › Cable length 5 m
  - › With flying lead
- 



**115112** C-M12F08-08X025PU05,0-MA-115112

▼ Features

- › M12 female plug, 8-pin
- › Straight plug connector
- › PUR cable
- › Cable length 5 m
- › With flying lead

---

▼ Connection cable with plug connector M12, 8-pin, 10m



**100178** C-M12F08-08X025PV10,0-MA-100178

▼ Features

- › M12 female plug, 8-pin
- › Straight plug connector
- › PVC cable
- › Cable length 10 m
- › With flying lead



**115113** C-M12F08-08X025PU10,0-MA-115113

▼ Features

- › M12 female plug, 8-pin
- › Straight plug connector
- › PUR cable
- › Cable length 10 m
- › With flying lead

---

▼ Connection cable with plug connector M12, 8-pin, 20m



**100179** C-M12F08-08X025PV20,0-MA-100179

▼ Features

- › M12 female plug, 8-pin
- › Straight plug connector
- › PVC cable
- › Cable length 20 m
- › With flying lead



**115114** C-M12F08-08X025PU20,0-MA-115114

▼ Features

- › M12 female plug, 8-pin
- › Straight plug connector
- › PUR cable
- › Cable length 20 m
- › With flying lead

---

▼ Connection cable with plug connector M12, 8-pin, 30m



**115116** C-M12F08-08X025PV30,0-MA-115116

▼ Features

- › M12 female plug, 8-pin
- › Straight plug connector
- › PVC cable
- › Cable length 30 m
- › With flying lead



**115257** C-M12F08-08X025PU30,0-MA-115257

▼ Features

- › M12 female plug, 8-pin
- › Straight plug connector
- › PUR cable
- › Cable length 30 m

- › With flying lead

▼ Connection cable with 2 plug connectors M12, 1m



**123430** C-M12M08-08X025PV01,0-M12F08-123430

▼ Features

- › 8-pin M12 male plug, straight
- › 8-pin M12 female connector, straight
- › PVC cable
- › Cable length 1m

▼ Connection cable with 2 plug connectors M12, 2m



**123431** C-M12M08-08X025PV02,0-M12F08-123431

▼ Features

- › 8-pin M12 male plug, straight
- › 8-pin M12 female connector, straight
- › PVC cable
- › Cable length 2m

▼ Connection cable with 2 plug connectors M12, 5m



**123432** C-M12M08-08X025PV05,0-M12F08-123432

▼ Features

- › 8-pin M12 male plug, straight
- › 8-pin M12 female connector, straight
- › PVC cable
- › Cable length 5m

▼ Connection cable with 2 plug connectors M12, 10m





**123433** C-M12M08-08X025PV10,0-M12F08-123433



▼ Features

- › 8-pin M12 male plug, straight
- › 8-pin M12 female connector, straight
- › PVC cable
- › Cable length 10m

## Instructions









▼ Manual de instrucciones Barreras/cortinas fotoeléctricas LCA 4

	Doc. no.	Version	Language	Download
Betriebsanleitung Lichtgitter/ Lichtvorhänge LCA 4	2504709	02-02/18	 	 5.2 MB
Operating Instructions Light Grids/ Light Curtains LCA 4				

Mode d'emploi Barrières photoélectriques / rideaux lumineux LCA 4	2504709	02-02/18		 3.1 MB
Manual de instrucciones Barreras/cortinas fotoeléctricas LCA 4	2504709	02-02/18		 3.1 MB







## Catalogs

- Light grids and light curtains LCA Barreras fotoeléctricas y cortinas fotoeléctricas LCA Barrières photoélectriques et rideaux lumineux LCA Lichtgitter und Lichtvorhänge LCA

	Doc. no.	Version	Language	Download
Lichtgitter und Lichtvorhänge LCA	157084	03-03/18		 2.5 MB
Barrières photoélectriques et rideaux lumineux LCA	157086	03-03/18		 2.5 MB
Barreras fotoeléctricas y cortinas fotoeléctricas LCA	157087	03-03/18		 2.5 MB
Light grids and light curtains LCA	157085	03-03/18		 2.5 MB

## Declaration of conformity

- EU-Konformitätserklärung

	Doc. no.	Version	Language	Download
EU-Konformitätserklärung Declaración UE de conformidad Déclaration UE de conformité Dichiarazione di conformità EU declaration of conformity	2503625	02-08/17	    	 0.2 MB