

ITEM 156607 LCA-4TR-S1-14-460-AP-156607

Description	Technical data	Accessories	Downloads
-------------	----------------	-------------	-----------



### Features

- › Light curtain slave 1
- › For cascading (series connection)
- › Resolution 14 mm
- › Protective field height 460 mm
- › Range 6 m
- › With plug connector M12
- › Installation material is included with the product

### Protective function

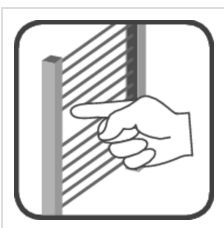

- › Figure  
finger protection

### Cascading (series connection)

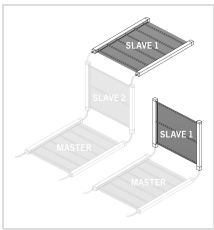

› Figure

Following combinations are possible:

**Variante A:** Master-slave 2-slave 1

**Variante B:** Master-slave 1

### LED function display



› Figure

Transmitter



› Figure

Receiver

<b>LED OK</b>	Normal operation
<b>LED ERROR</b>	Faults
<b>LED STOP</b>	Stop
<b>LED TEST</b>	Test function
<b>LED START</b>	Start/ restart
<b>LED SIGNAL LOW</b>	Weak signal

### Connector assignment transmitter / receiver

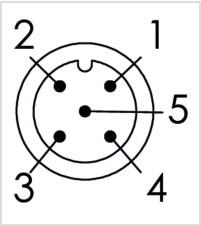
Plug connector (view of connection side)	Pin	Designation	Function	Conductor coloring of connection cable
	1	24 V DC	Operating voltage, 24 V DC	BN
	2	LINE_A	Communication MASTER-SLAVE	WH
	3	0 V DC	Operating voltage, 0 V DC	BU
	4	LINE_B	Communication MASTER-SLAVE	BK
	5	FE	Function earth (must be connected to meet the EMC requirements)	GY

## Approvals



## Mechanical values and environment

Resolution	14 mm
Height of the protective field	460 mm
Height of the sensor	513 mm
Maximum length of connection cables	100 m
Range of the protective field	6000 mm
Dimensions	28x30 mm [1]
Ambient temperature	-20 ... 55 °C
Degree of protection	IP 65 / IP 67
Installation position	Any [2]
Connection	Plug connector M12 (5-pin transmitter / 8-pin receiver) [3]

## Electrical connection ratings

Cascadable	Yes [4]
Muting possible	In combination with external sensors and an evaluation unit
Operating voltage DC	24 V DC -20% ... +20%
Current consumption	400 mA
Power consumption	
	Transmitter 1 W
	Receiver 2 W

LED indicator	Yes [5]
---------------	---------

### Reliability values acc. to EN ISO 13849-1

ESPE type	4 [6]
Performance Level	PL e [7]
PFH <sub>D</sub>	1,38x10 <sup>-8</sup>
Safety Integrity Level	SIL 3 / SILCL 3 [8]
Mission time	20 y

[1] In cross-section

[2] Optional: adjustable holders

[3] Master-slave1 and master-slave2-slave1 connections are 2x M12 5-pin

[4] Max. 50m connection cable between master and slaves

[5] Self-diagnostics and status

[6] Acc. to EN 61496-1

[7] acc. to EN ISO 13849-1

[8] According to IEC 61508-1...4 / IEC 62061

### Dimension drawing

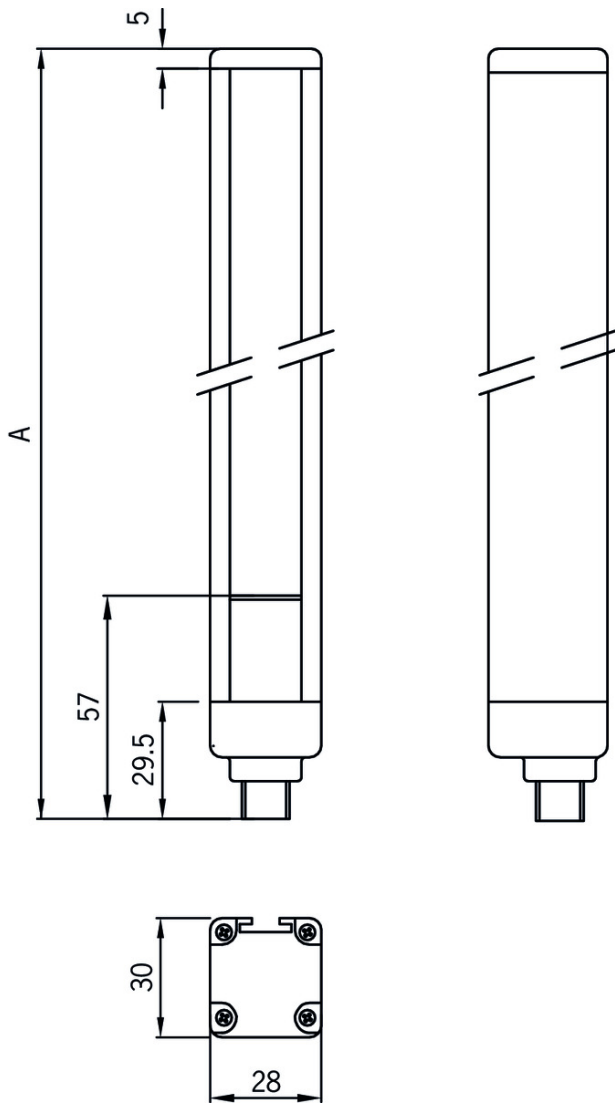

**Legende**

A = Height of the sensor (see technical data)

**Wiring diagram transmitter**

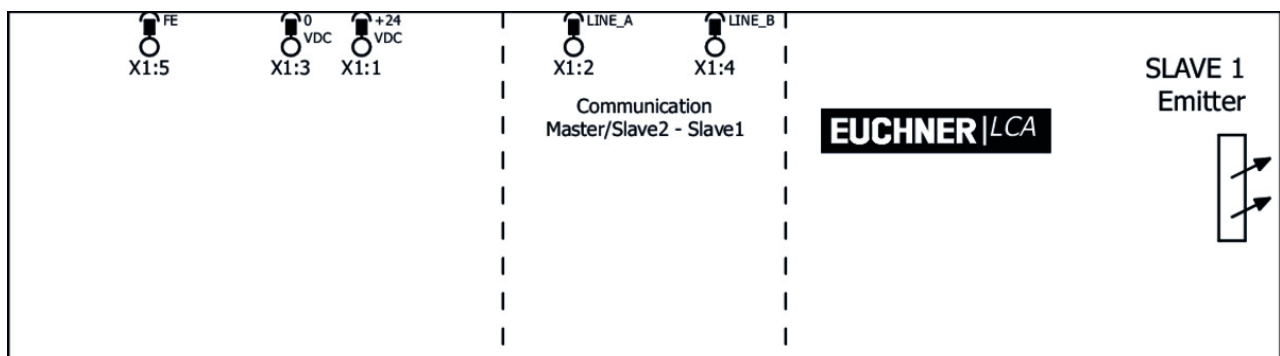

## Wiring diagram receiver

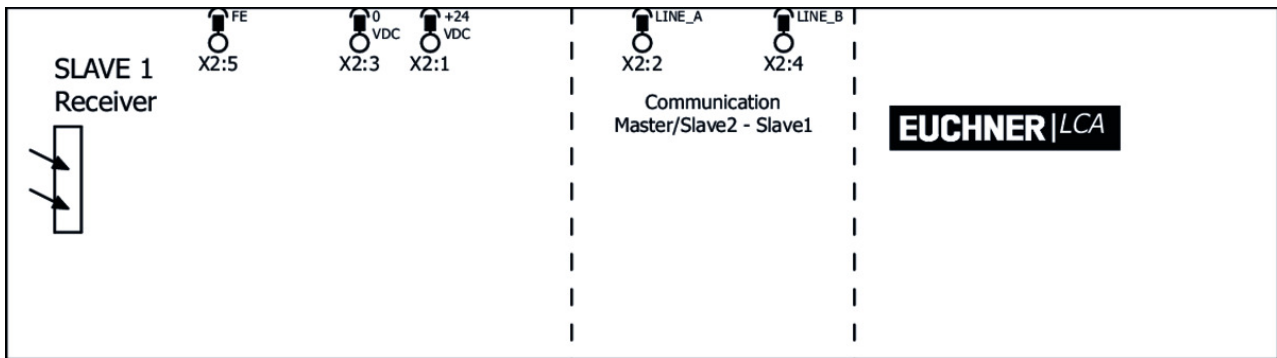

## Mounting accessories

- ✓ Socket for mounting pillars 202 x 224 x 55 mm



**156884** AM-OS-P-AA-156884

### ✓ Features

- › Socket for mounting pillars
- › Spring-mounted floor plate made of steel
- › Improved compensation of unevenness
- › Adjustable via adjusting screws
- › Height 55 mm

- ✓ Socket for mounting pillars 202 x 224 x 34 mm



**156885** AM-OS-P-AB-156885

### ✓ Features

- › Socket for mounting pillars
- › Adjustable via adjusting screws
- › Height 34 mm

- ✓ Mounting pillar for protective field heights from 160 - 610 mm or 2 beam light grids



**156886** AM-OS-C-A1-1000-156886

### ✓ Features

- › Mounting pillar for light grids and light curtains LCA
- › For protective field heights from 160 - 610 mm or for 2 beams
- › Protects against damage
- › Straightforward adjustment using spherical circular level in the cover

- ✓ Mounting pillar with cable gland for protective field heights from 160 - 610 mm or for 2 beam light grids



**156890** AM-OS-C-A1-M-1000-156890

### ✓ Features

- › Mounting pillar for light grids and light curtains LCA
- › For protective field heights from 160 - 610 mm or for 2 beams
- › With integrated cable gland PG11
- › Protects against damage

- › Straightforward adjustment using spherical circular level in the cover

- ▼ 8 x vibration damper for protective field heights from 310 - 1,060 mm



**156917** AM-OS-D-V08-156917

▼ Features

- › Vibration damper for light grids and light curtains LCA
- › For protective field heights 310 - 1060 mm
- › Packaging unit 8 pcs.
- › For reducing vibration
- › Protects against damage
- › Installation either on the product or on mounting pillar

- ▼ 4 x adjustable holder



**156919** AM-OS-B-A1-V04-156919

▼ Features

- › Set of 4 holders for light grids and light curtains LCA
- › For protective field heights up to 1210 mm
- › Adjustable horizontally / vertically
- › Quick mount using two screws
- › Can be mounted directly on LCA

- ▼ 4 x adjustable holder 180°



**156921** AM-OS-B-A2-V04-156921

▼ Features

- › Set of 4 holders for light grids and light curtains LCA
- › Can be rotated by 180°
- › Adjustable horizontally / vertically
- › Quick mount using two screws
- › Can be mounted directly on LCA

## Function expansion

- ▼ Mounting pillar with deflection mirror for protective field heights from 160 - 610 mm or for 2 beam light grids



**156894** AE-OS-SC-1000-156894

▼ Features

- › Mounting pillar with deflection mirror for light grids and light curtains LCA
- › For protective field heights from 160 - 610 mm or for 2 beams
- › Protects against damage
- › Straightforward adjustment using spherical circular level in the cover

- ▼ Deflection mirror for protective field height 460 mm



**156905** AE-OS-S-460-156905

▼ Features

- › Deflection mirror with adjustable holder for light curtains LCA
- › For protective field height 460 mm

---

## Miscellaneous accessories

---

### ▾ Laser alignment aid



#### **156915** AY-OS-LSR-156915

##### ▾ Features

- › Laser alignment aid for light grids and light curtains LCA
  - › Light source: Laser diode – wavelength 650 nm
  - › Laser class 2
  - › Usable range 100 m
  - › Straightforward clamping on the transmitter
- 

### ▾ Test rod Ø 14 mm



#### **156922** AY-OS-FTR-14-156922

##### ▾ Features

- › Test rod for light curtains LCA
  - › Used for function test
  - › Ø 14 mm
  - › Cylinder with matt surface
- 

## Connection material

---

### ▾ Connection cable for cascading M12, 0.3m



#### **156926** C-M12F05-05X034PV0,30-M12F05-156926

##### ▾ Features

- › Connection cable for cascading
  - › 2 x M12 female plug, 5-pin
  - › Straight plug connector
  - › PVC cable
  - › Cable length 0.3 m
- 

### ▾ Connection cable for cascading M12, 3m



#### **156927** C-M12F05-05X034PV03,0-M12F05-156927

##### ▾ Features

- › Connection cable for cascading
  - › 2 x M12 female plug, 5-pin
  - › Straight plug connector
  - › PVC cable
  - › Cable length 3 m
- 

### ▾ Connection cable for cascading M12, 5m



#### **156928** C-M12F05-05X034PV05,0-M12F05-156928

##### ▾ Features

- › Connection cable for cascading
- › 2 x M12 female plug, 5-pin



- › Straight plug connector
- › PVC cable
- › Cable length 5 m

▼ Connection cable for cascading M12, 10m



**156929** C-M12F05-05X034PV10,0-M12F05-156929

▼ Features

- › Connection cable for cascading
- › 2 x M12 female plug, 5-pin
- › Straight plug connector
- › PVC cable
- › Cable length 10 m

▼ Connection cable for cascading M12, 25m



**156930** C-M12F05-05X034PV25,0-M12F05-156930

▼ Features

- › Connection cable for cascading
- › 2 x M12 female plug, 5-pin
- › Straight plug connector
- › PVC cable
- › Cable length 25 m

## Instructions

▼ Manual de instrucciones Barreras/cortinas fotoeléctricas LCA 4

	Doc. no.	Version	Language	Download
Betriebsanleitung Lichtgitter/ Lichtvorhänge LCA 4 Operating Instructions Light Grids/ Light Curtains LCA 4	2504709	02-02/18		5.2 MB
Mode d'emploi Barrières photoélectriques / rideaux lumineux LCA 4	2504709	02-02/18		3.1 MB
Manual de instrucciones Barreras/cortinas fotoeléctricas LCA 4	2504709	02-02/18		3.1 MB

## Catalogs





▼ Light grids and light curtains LCA Barreras fotoeléctricas y cortinas fotoeléctricas LCA Barrières photoélectriques et rideaux lumineux LCA Lichtgitter und Lichtvorhänge LCA

	Doc. no.	Version	Language	Download
Lichtgitter und Lichtvorhänge LCA	157084	03-03/18		2.5 MB
Barrières photoélectriques et rideaux lumineux LCA	157086	03-03/18		2.5 MB

Barreras fotoeléctricas y cortinas fotoeléctricas LCA	157087	03-03/18		 2.5 MB
Light grids and light curtains LCA	157085	03-03/18		 2.5 MB

## Declaration of conformity

### EU-Konformitätserklärung

	Doc. no.	Version	Language	Download
EU-Konformitätserklärung	2503625	02-08/17		 0.2 MB
Declaración UE de conformidad				
Déclaration UE de conformité				
Dichiarazione di conformità				
EU declaration of conformity			