

ITEM 156632 LCA-4TR-S2-30-910-AP-156632

Description	Technical data	Accessories	Downloads
-------------	----------------	-------------	-----------



Features

- › Light curtain slave 2
- › For cascading (series connection)
- › Resolution 30 mm
- › Protective field height 910 mm
- › Range 12 m
- › With plug connector M12
- › Installation material is included with the product

Protective function



- › Figure
hand protection

Cascading (series connection)

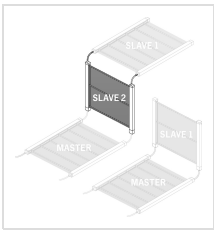

› Figure

Following combinations are possible:

Variante A: Master-slave 2-slave 1

Variante B: Master-slave 1

LED function display



› Figure

Transmitter



› Figure

Receiver

LED OK Normal operation

LED ERROR Fault state

LED STOP Stop state

LED TEST Test function

LED START Start/ restart

Connector assignment transmitter / receiver

Plug connector (view of connection side)	Pin	Designation	Function	Conductor coloring of connection cable
	1	24 V DC	Operating voltage, 24 V DC	BN
	2	LINE_A	Communication MASTER-SLAVE	WH
	3	0 V DC	Operating voltage, 0 V DC	BU
	4	LINE_B	Communication MASTER-SLAVE	BK

Plug connector (view of connection side)	Pin	Designation	Function	Conductor coloring of connection cable
	5	FE	Function earth (must be connected to meet the EMC requirements)	GY

Approvals



Mechanical values and environment

Resolution	30 mm
Height of the protective field	910 mm
Height of the sensor	963 mm
Maximum length of connection cables	100 m
Range of the protective field	12000 mm
Dimensions	28x30 mm [1]
Ambient temperature	-30 ... 55 °C
Degree of protection	IP 65 / IP 67
Installation position	Any [2]
Connection	Plug connector M12 (5-pin transmitter / 8-pin receiver) [3]

Electrical connection ratings

Cascadable	Yes [4]
Muting possible	In combination with external sensors and an evaluation unit
Operating voltage DC	24 V DC -20% ... +20%
Current consumption	400 mA
Power consumption	
Transmitter	1 W
Receiver	2 W
LED indicator	Yes [5]

Reliability values acc. to EN ISO 13849-1

ESPE type	4 [6]
Performance Level	PL e [7]
PFH _D	1,43x10 ⁻⁸
Safety Integrity Level	SIL 3 / SILCL 3 [8]

- [1] In cross-section
- [2] Optional: adjustable holders
- [3] Master-slave1 and master-slave2-slave1 connections are 2x M12 5-pin
- [4] Max. 50m connection cable between master and slaves
- [5] Self-diagnostics and status
- [6] Acc. to EN 61496-1
- [7] acc. to EN ISO 13849-1
- [8] According to IEC 61508-1...4 / IEC 62061

Dimension drawing

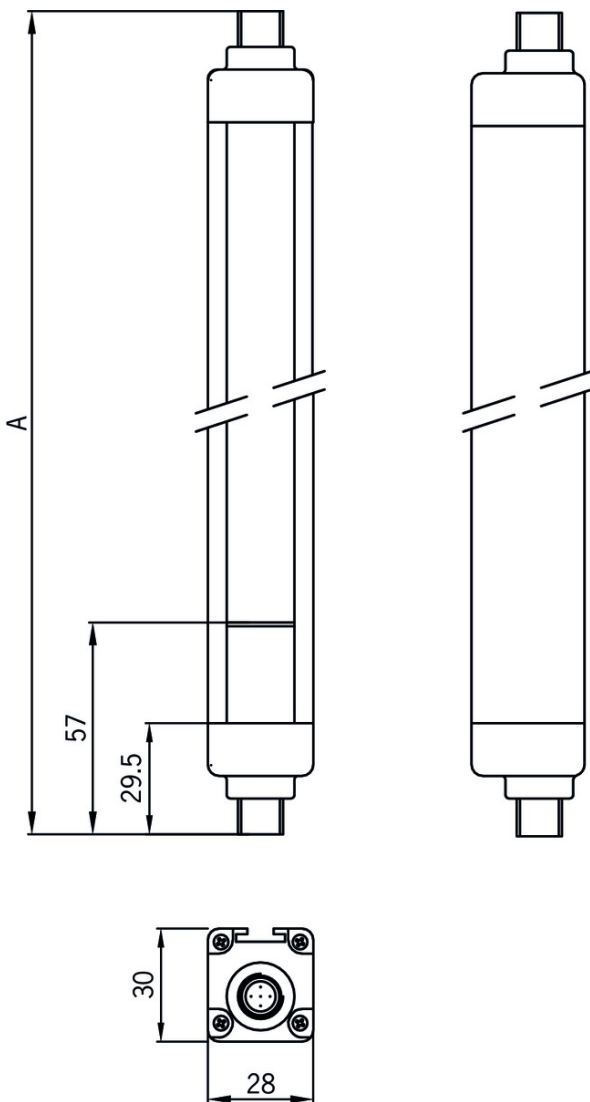

Legende

A = Height of the sensor (see technical data)

Wiring diagram transmitter

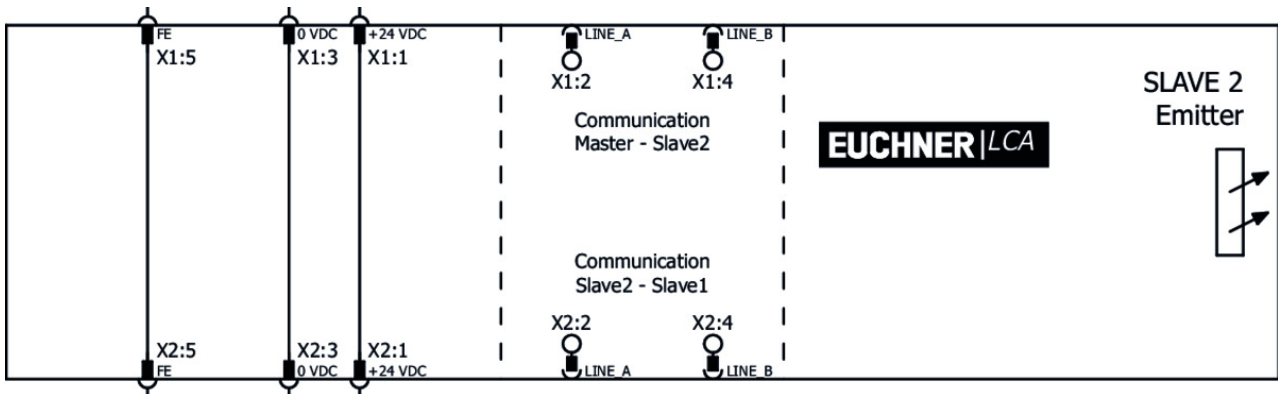

Wiring diagram receiver

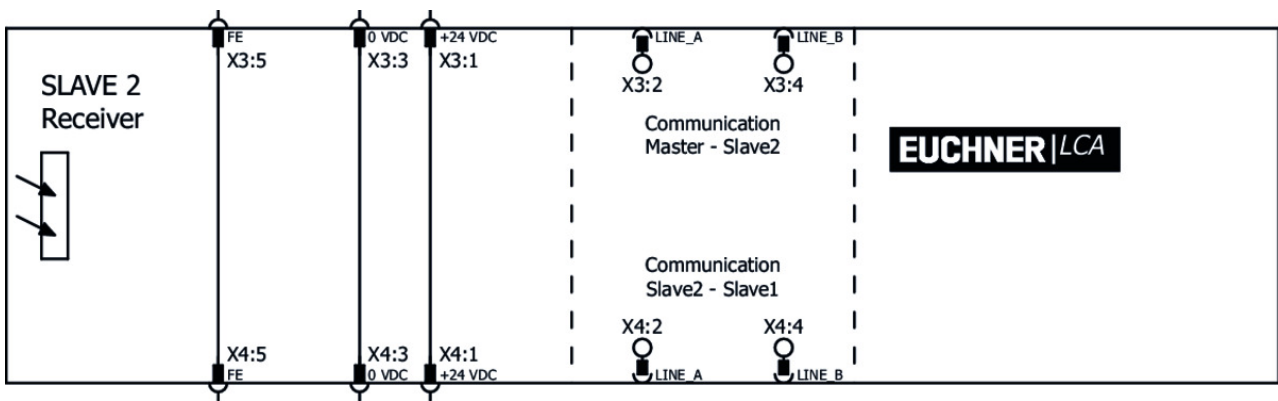

Mounting accessories

- ✓ Socket for mounting pillars 202 x 224 x 55 mm



156884 AM-OS-P-AA-156884

- ✓ Features

- › Socket for mounting pillars
- › Spring-mounted floor plate made of steel
- › Improved compensation of unevenness
- › Adjustable via adjusting screws
- › Height 55 mm

- ✓ Socket for mounting pillars 202 x 224 x 34 mm



156885 AM-OS-P-AB-156885

- ✓ Features

- › Socket for mounting pillars
- › Adjustable via adjusting screws
- › Height 34 mm

- ✓ Mounting pillar for protective field heights from 760 - 1060 mm or 3 - 4 beam light grids

156887 AM-OS-C-A1-1200-156887



- ✔ Features
 - › Mounting pillar for light grids and light curtains LCA
 - › For protective field heights from 760 - 1060 mm or 3 - 4 beams
 - › Protects against damage
 - › Straightforward adjustment using spherical circular level in the cover
-

- ✔ Mounting pillar with cable gland for protective field heights from 760 - 1060 mm or 3 - 4 beam light grids



- ✔ **156891** AM-OS-C-A1-M-1200-156891
 - ✔ Features
 - › Mounting pillar for light grids and light curtains LCA
 - › For protective field heights from 760 - 1060 mm or for 3 - 4 beams
 - › With integrated cable gland PG11
 - › Protects against damage
 - › Straightforward adjustment using spherical circular level in the cover
-

- ✔ 8 x vibration damper for protective field heights from 310 - 1,060 mm



- ✔ **156917** AM-OS-D-V08-156917
 - ✔ Features
 - › Vibration damper for light grids and light curtains LCA
 - › For protective field heights 310 - 1060 mm
 - › Packaging unit 8 pcs.
 - › For reducing vibration
 - › Protects against damage
 - › Installation either on the product or on mounting pillar
-

- ✔ 4 x adjustable holder



- ✔ **156919** AM-OS-B-A1-V04-156919
 - ✔ Features
 - › Set of 4 holders for light grids and light curtains LCA
 - › For protective field heights up to 1210 mm
 - › Adjustable horizontally / vertically
 - › Quick mount using two screws
 - › Can be mounted directly on LCA
-

- ✔ 4 x adjustable holder 180°



- ✔ **156921** AM-OS-B-A2-V04-156921
 - ✔ Features
 - › Set of 4 holders for light grids and light curtains LCA
 - › Can be rotated by 180°
 - › Adjustable horizontally / vertically
 - › Quick mount using two screws
 - › Can be mounted directly on LCA
-

Function expansion

- ✔ Mounting pillar with deflection mirror for protective field heights from 760 - 910 mm or for 3

beam light grids



156895 AE-OS-SC-1200-156895

✓ Features

- › Mounting pillar with deflection mirror for light grids and light curtains LCA
- › For protective field heights from 760 - 910 mm or for 3 beams
- › Protects against damage
- › Straightforward adjustment using spherical circular level in the cover

✓ Deflection mirror for protective field height 910 mm or 3 beam light grids



156908 AE-OS-S-910-156908

✓ Features

- › Deflection mirror with adjustable holder for light grids and light curtains LCA
- › For protective field height 910 mm or 3 beams

Miscellaneous accessories

✓ Laser alignment aid



156915 AY-OS-LSR-156915

✓ Features

- › Laser alignment aid for light grids and light curtains LCA
- › Light source: Laser diode - wavelength 650 nm
- › Laser class 2
- › Usable range 100 m
- › Straightforward clamping on the transmitter

✓ Test rod Ø 30 mm



156923 AY-OS-FTR-30-156923

✓ Features

- › Test rod for light curtains LCA
- › Used for function test
- › Ø 30 mm
- › Cylinder with matt surface

Connection material

✓ Connection cable for cascading M12, 0.3m



156926 C-M12F05-05X034PV0,30-M12F05-156926

✓ Features

- › Connection cable for cascading
- › 2 x M12 female plug, 5-pin
- › Straight plug connector
- › PVC cable
- › Cable length 0.3 m

▼ Connection cable for cascading M12, 3m



156927 C-M12F05-05X034PV03,0-M12F05-156927

▼ Features

- › Connection cable for cascading
- › 2 x M12 female plug, 5-pin
- › Straight plug connector
- › PVC cable
- › Cable length 3 m

▼ Connection cable for cascading M12, 5m



156928 C-M12F05-05X034PV05,0-M12F05-156928

▼ Features

- › Connection cable for cascading
- › 2 x M12 female plug, 5-pin
- › Straight plug connector
- › PVC cable
- › Cable length 5 m

▼ Connection cable for cascading M12, 10m



156929 C-M12F05-05X034PV10,0-M12F05-156929

▼ Features

- › Connection cable for cascading
- › 2 x M12 female plug, 5-pin
- › Straight plug connector
- › PVC cable
- › Cable length 10 m

▼ Connection cable for cascading M12, 25m



156930 C-M12F05-05X034PV25,0-M12F05-156930

▼ Features

- › Connection cable for cascading
- › 2 x M12 female plug, 5-pin
- › Straight plug connector
- › PVC cable
- › Cable length 25 m

Instructions









▼ Manual de instrucciones Barreras/cortinas fotoeléctricas LCA 4

	Doc. no.	Version	Language	Download
Betriebsanleitung Lichtgitter/ Lichtvorhänge LCA 4	2504709	02-02/18		5.2 MB
Operating Instructions Light Grids/ Light Curtains LCA 4				

Mode d'emploi Barrières photoélectriques / rideaux lumineux LCA 4	2504709	02-02/18		 3.1 MB
Manual de instrucciones Barreras/cortinas fotoeléctricas LCA 4	2504709	02-02/18		 3.1 MB







Catalogs

 Light grids and light curtains LCA Barreras fotoeléctricas y cortinas fotoeléctricas LCA Barrières photoélectriques et rideaux lumineux LCA Lichtgitter und Lichtvorhänge LCA

	Doc. no.	Version	Language	Download
Lichtgitter und Lichtvorhänge LCA	157084	03-03/18		 2.5 MB
Barrières photoélectriques et rideaux lumineux LCA	157086	03-03/18		 2.5 MB
Barreras fotoeléctricas y cortinas fotoeléctricas LCA	157087	03-03/18		 2.5 MB
Light grids and light curtains LCA	157085	03-03/18		 2.5 MB

Declaration of conformity

 EU-Konformitätserklärung

	Doc. no.	Version	Language	Download
EU-Konformitätserklärung Declaración UE de conformidad Déclaration UE de conformité Dichiarazione di conformità EU declaration of conformity	2503625	02-08/17	    	 0.2 MB