

ITEM 072970 HWA100T100A05/V10

Description	Technical data	Accessories	Downloads
-------------	----------------	-------------	-----------



Features

- › 100 detent positions per revolution
- › Mechanical detent mechanism
- › 100 pulses per revolution
- › Center point fixing

Notes

- › Output A05 suitable for Siemens control systems with RS422 input
- › Packaging unit 10 pieces

Approvals



Mechanical values and environment

Material	Plastic
Weight	
	Net 0.1
Ambient temperature	0 ... 50 °C
Atmospheric humidity (condensation not permissible)	0.8
Degree of protection	
	IEC 529 IP65 [1]
	acc. to NEMA 250 250-12 [2]
Mechanical life	1 x 10 ⁶
Connection	Screw terminals 6-pole
Detent positions per revolution	100

Electrical connection ratings

Operating voltage DC	5 V DC -10% ... 10%
Current consumption	
	Without load max.80 mA
Type of output	RS422
Pulses per revolution	2x100
Output voltage	In accordance with RS422A

Miscellaneous

Additional feature	
	Front panel thickness 1.5 - 2.0mm
Detent mechanism	Mechanical
Packaging unit	10

[1, 2] On the front

Dimension drawing

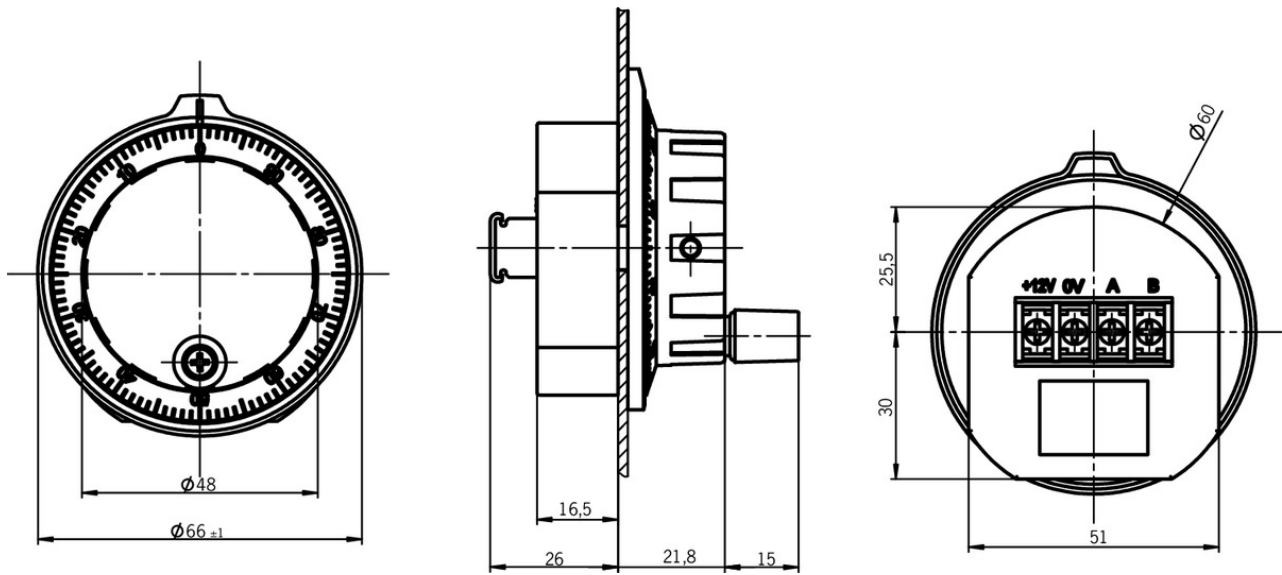

Dimension drawing

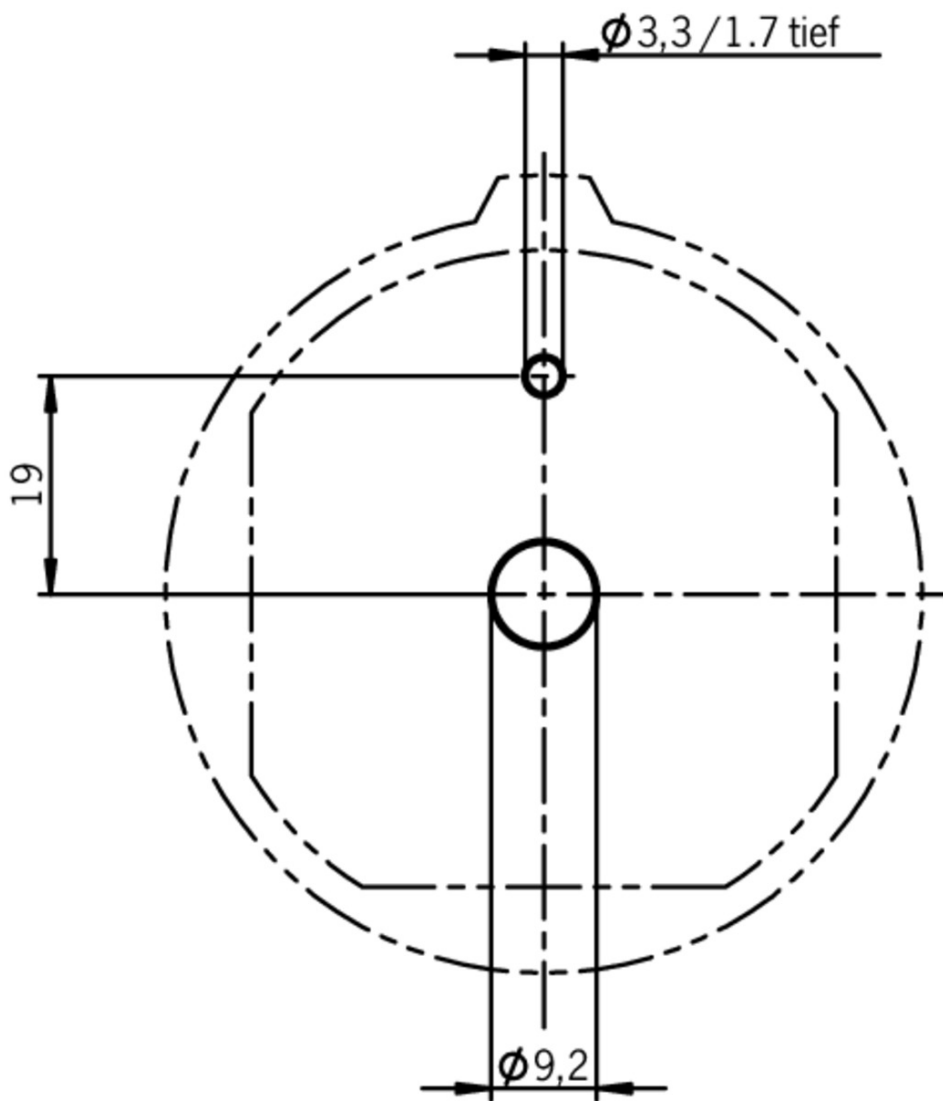

Terminal assignment

$+5V$ $0V$ A \bar{A} B \bar{B}

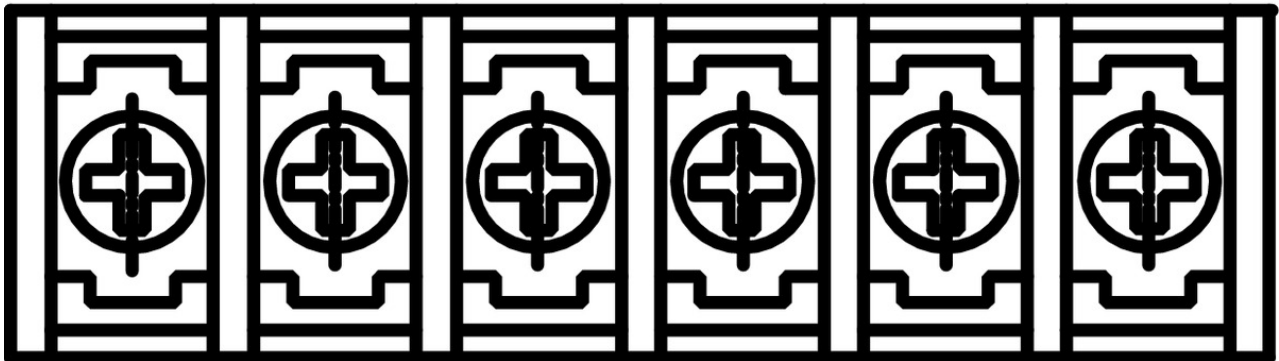



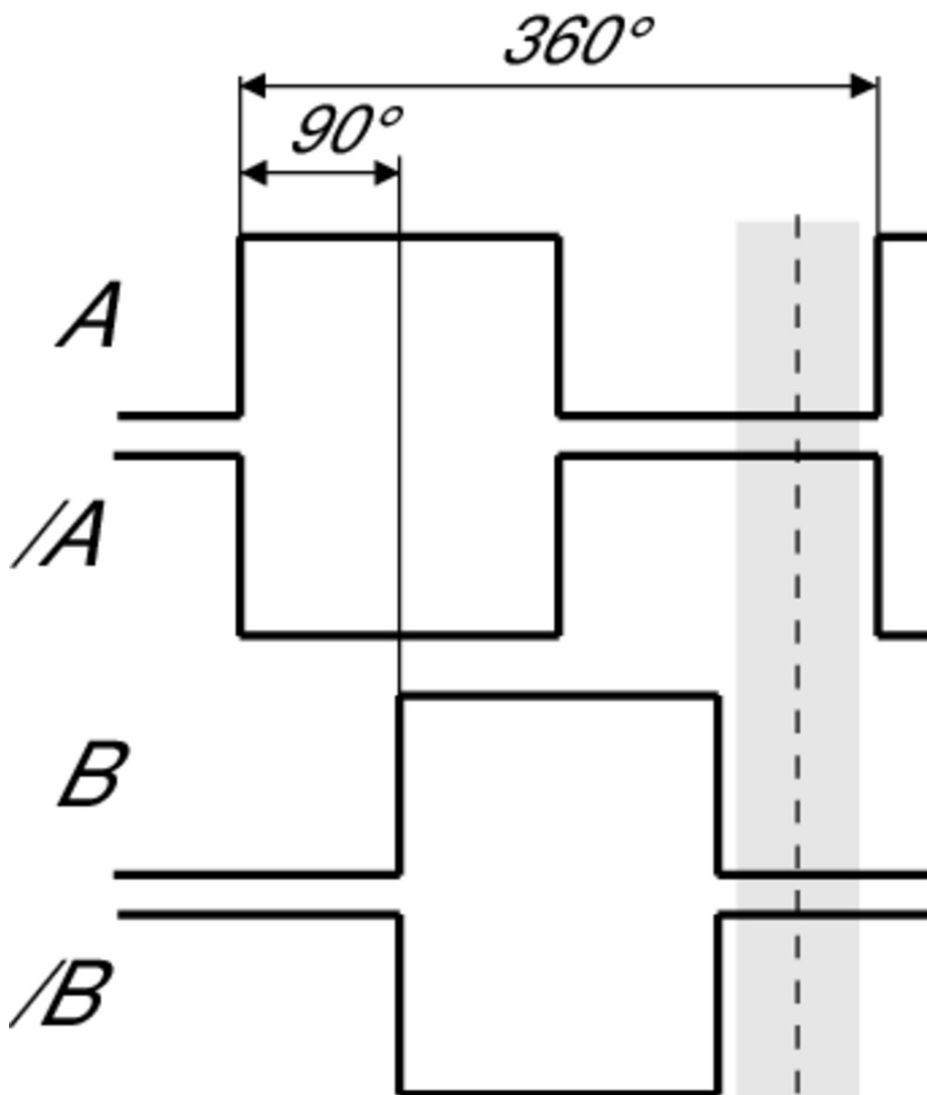

Ausgangssignale









Instructions

☑ Betriebsanleitung Elektronisches Handrad HWA/HWB

	Doc. no.	Version	Language	Download
Betriebsanleitung Elektronisches Handrad HWA/HWB	072993	02-08/06		 1.2 MB
Mode d'emploi de la manivelle électronique HWA/HWB				
Istruzioni di impiego volantino elettronico HWA/HWB				
Operating instructions for electronic handwheel HWA/HWB				

Catalogs

☑ Handbediengeräte/Handräder Hand-Held Pendant Stations/Handwheels Pupitres portables/Manivelles

	Doc. no.	Version	Language	Download
Handbediengeräte/Handräder	098619	08-09/17		 3.0 MB
Pupitres portables/Manivelles	111529	08-09/17		 3.0 MB
Hand-Held Pendant Stations/Handwheels	099443	08-09/17		 3.0 MB

CAD data

CAD data for this item on TraceParts