

ITEM 105135 HKB100S7A12

Description	Technical data	Accessories	Downloads
-------------	----------------	-------------	-----------



Features

- › 100 detent positions per revolution
- › Wear-free magnetic detent mechanism
- › 100 pulses per revolution
- › Ideal for flat machine panels and small, light hand-held pendant stations like the housing HBA/HBM

Approvals



Mechanical values and environment

Material	Aluminum
Weight	Net 0.095 [1]
Ambient temperature	0 ... 50 °C

Atmospheric humidity (condensation not permissible)	0.8
Degree of protection IEC 529 IP65 ^[2] acc. to NEMA 250 250-12 ^[3]	
Resilience to vibration Vibration (3 axes) DIN/IEC 68-2-6 Shock (3 axes) DIN/IEC 68-2-27	
Tightening torque	max.0,25 Nm
Connection	Screw terminal
Detent positions per revolution	100

Electrical connection ratings

Operating voltage DC	10 ... 30 V DC
Current consumption Without load	max.80 mA
EMC protection requirements Acc. to CE	EN 61000-6-2, EN 61000-6-4
Type of output	RS422
Connection cross-section	0,08 ... 1,5 mm ²
Connection cross-section, AWG	28 ... 16 AWG
Pulses per revolution	2x100
Output voltage	In accordance with RS422A

Miscellaneous

Detent mechanism	Magnetic
------------------	----------

[1] Without dial

[2, 3] On the front

Dimension drawing

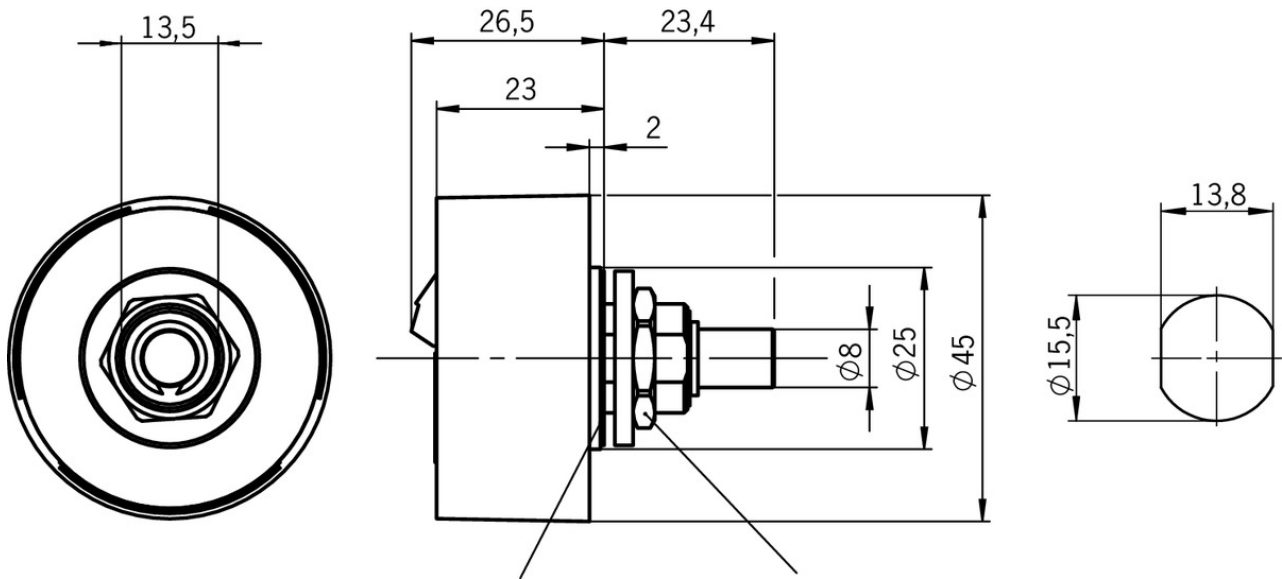

Terminal assignment

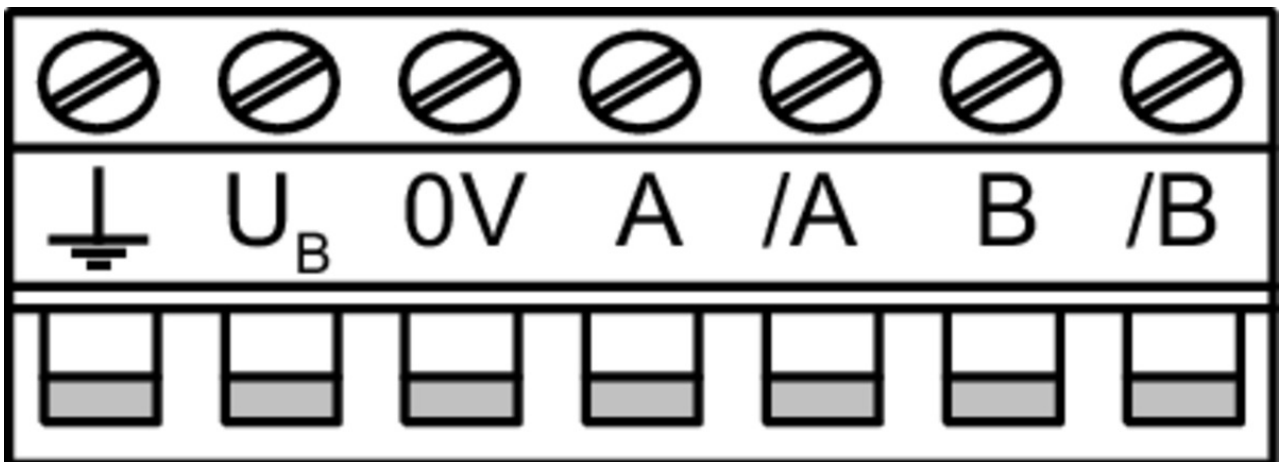

Ausgangssignale

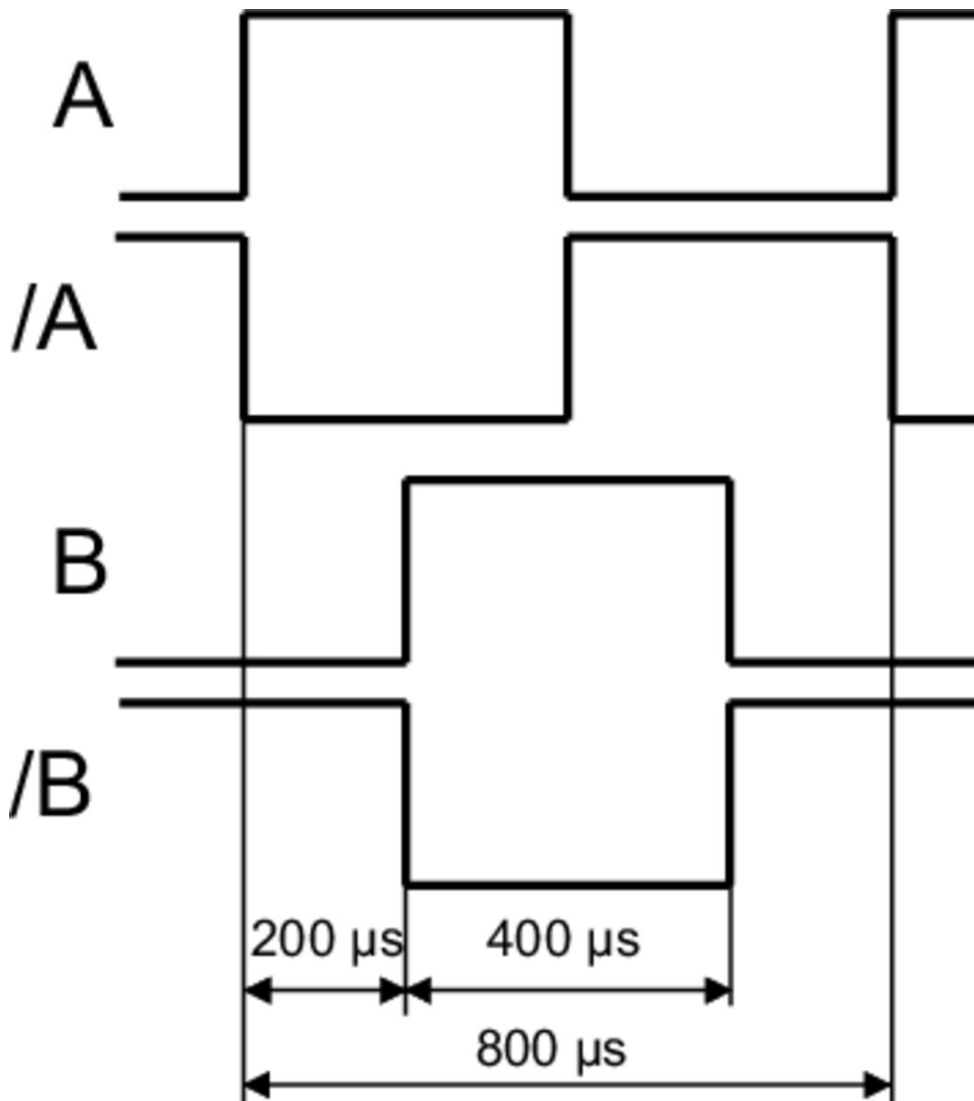

Function expansion

- ✓ Dial for handwheel HKB, suitable for front panels HKB



100914 EINSTELLRAD HKB 58 METALL SIL/SW

- ✓ All-metal dial for handwheel HKB, for installation in machine panel or HBA/HBM



111992 EINSTELLRAD HKB 66,5 METALL SIL/SW





- ✓ Plastic dial for handwheel HKB, for installation in machine panel or HBA/HBM



105961 EINSTELLRAD HKB/HBA







Instructions

▼ Betriebsanleitung Elektronisches Handrad HKB

	Doc. no.	Version	Language	Download
Betriebsanleitung Elektronisches Handrad HKB	103470	04-05/09		 1.2 MB
Mode d'emploi de la manivelle électronique HKB				
Istruzioni di impiego volante elettronico HKB				
Operating instructions for electronic handwheel HKB				

Catalogs

▼ Handbediengeräte/Handräder Hand-Held Pendant Stations/Handwheels Pupitres portables/Manivelles

	Doc. no.	Version	Language	Download
Handbediengeräte/Handräder	098619	08-09/17		 3.0 MB
Pupitres portables/Manivelles	111529	08-09/17		 3.0 MB
Hand-Held Pendant Stations/Handwheels	099443	08-09/17		 3.0 MB

CAD data

CAD data for this item on TraceParts