

## ITEM 105136 HKB100S7G05

Description	Technical data	Accessories	Downloads
-------------	----------------	-------------	-----------



### Features

- › 100 detent positions per revolution
- › Wear-free magnetic detent mechanism
- › 100 pulses per revolution
- › Ideal for flat machine panels and small, light hand-held pendant stations like the housing HBA/HBM

### Notes

- › Output G05 suitable for Fanuc control systems

### Approvals



### Mechanical values and environment

Material	Aluminum
Weight	
	Net 0.095 [1]
Ambient temperature	0 ... 50 °C
Atmospheric humidity (condensation not permissible)	0.8
Degree of protection	
	IEC 529 IP65 [2]
	acc. to NEMA 250 250-12 [3]
Resilience to vibration	
	Vibration (3 axes) DIN/IEC 68-2-6
	Shock (3 axes) DIN/IEC 68-2-27
Tightening torque	max.0,25 Nm
Connection	Screw terminal 7-pole
Detent positions per revolution	100

### Electrical connection ratings

Operating voltage DC	5 V DC -5% ... 5%
Current consumption	
	Without load max.80 mA
EMC protection requirements	
	Acc. to CE EN 61000-6-2, EN 61000-6-4
Type of output	Push-pull
Connection cross-section	0,08 ... 1,5 mm <sup>2</sup>
Connection cross-section, AWG	28 ... 16 AWG
Pulses per revolution	2x100
Output voltage	
	High(1) at 0 mAmin.4,0 V DC
	High(1) at 5 mAmin.3,4 V DC
	High(1) at 20 mAmin.3,0 V DC
	Low(0) at 15 mAmax.1,3 V DC

### Miscellaneous

Detent mechanism	Magnetic
------------------	----------

[1] Without dial

[2, 3] On the front



## Ausgangssignale

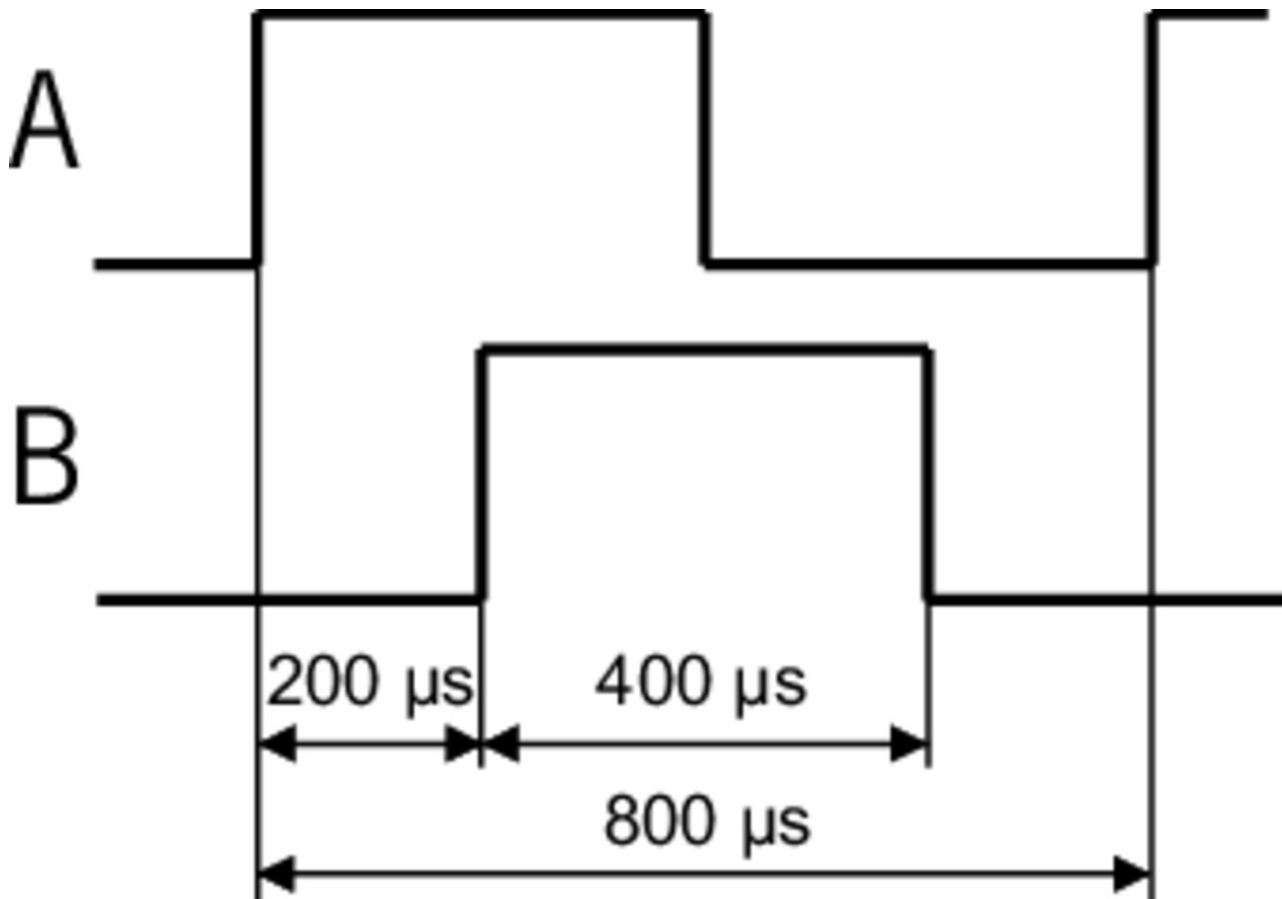

## Function expansion

- ✓ Dial for handwheel HKB, suitable for front panels HKB



**100914** EINSTELLRAD HKB 58 METALL SIL/SW

- ✓ All-metal dial for handwheel HKB, for installation in machine panel or HBA/HBM



**111992** EINSTELLRAD HKB 66,5 METALL SIL/SW





- ✓ Plastic dial for handwheel HKB, for installation in machine panel or HBA/HBM



**105961** EINSTELLRAD HKB/HBA







## Instructions

- ✓ Betriebsanleitung Elektronisches Handrad HKB

	Doc. no.	Version	Language	Download
Betriebsanleitung Elektronisches Handrad HKB Mode d'emploi de la manivelle électronique HKB Istruzioni di impiego volantino elettronico HKB Operating instructions for electronic handwheel HKB	103470	04-05/09	   	 1.2 MB

## Catalogs

- Handbediengeräte/Handräder Hand-Held Pendant Stations/Handwheels Pupitres portables/Manivelles

	Doc. no.	Version	Language	Download
Handbediengeräte/Handräder	098619	08-09/17		 3.0 MB
Pupitres portables/Manivelles	111529	08-09/17		 3.0 MB
Hand-Held Pendant Stations/Handwheels	099443	08-09/17		 3.0 MB

## CAD data

CAD data for this item on TraceParts