

ITEM 158081 CKS-A-L1B-SC-158081

Description	Technical data	Accessories	Downloads
-------------	----------------	-------------	-----------



Features

- › Key adapter with integrated CES read head
- › Suitable for connection to a CES-AZ evaluation unit or CES-FD field unit
- › Simple connection via plug connector M8
- › Front cover: black
- › High degree of protection IP 67
- › LED indicator

Important: Keys must be ordered separately!

Approvals



Mechanical values and environment

Housing material	PA6-GF30
Weight	

	Net	0,13 kg
Ambient temperature		-20 ... 70 °C
Degree of protection		
On installation in flat metal plate, thickness = 2mm		IP67 in installed state (only access side)
Mounting method		Fastening using screw clamp elements on rear
Mounting cut-out according to DIN 43700		33 x 68 mm
Installation position		On the front
Tightening torque		
Fixing screws in the clamping pieces on the rear		0,25 ... 0,35 Nm
Switching frequency		See operating instructions for the related evaluation unit
Connection		M8 plug connector, 3-pin
Cable length		
Maximum allowed		max.25 m
Method of operation		Inductive

Electrical connection ratings

Power supply	Via evaluation unit
LED indicator	White: valid actuator detected

Operating distance

Switching hysteresis	
Referred to the stop for the inserted actuator	1 mm ^[1]
Assured switch-off distance S_{ar}	
Referred to the stop for the inserted actuator	max.30 mm ^[2]
Assured operating distance S_{a0}	
Referred to the stop for the inserted actuator	min.2 mm ^[3]

[1, 2, 3] In conjunction with evaluation unit CES-AZ-xES-xxB

Dimension drawing

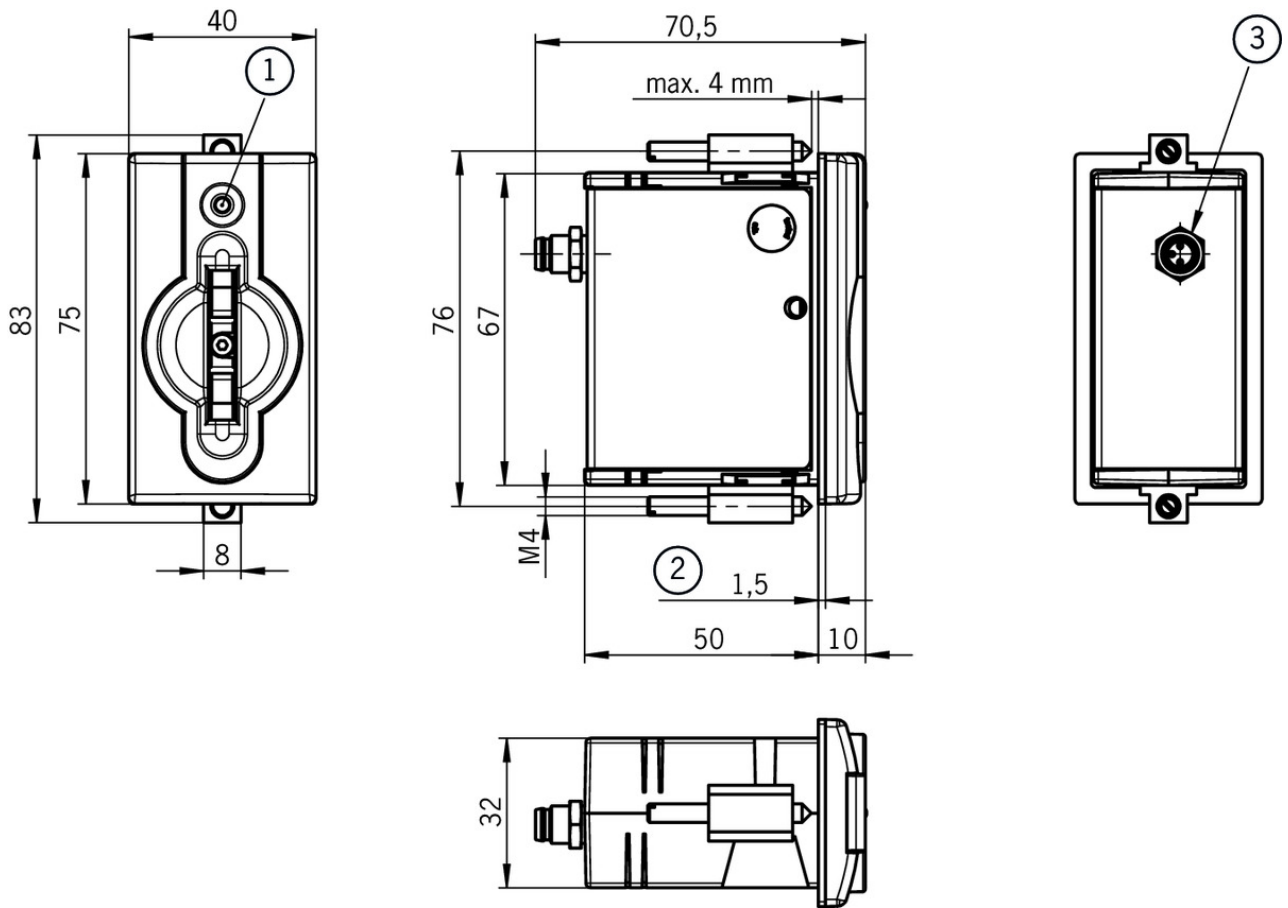

Legende

- 1 LED
- 2 Rubber seal
- 3 Plug connector M8

Wiring diagram

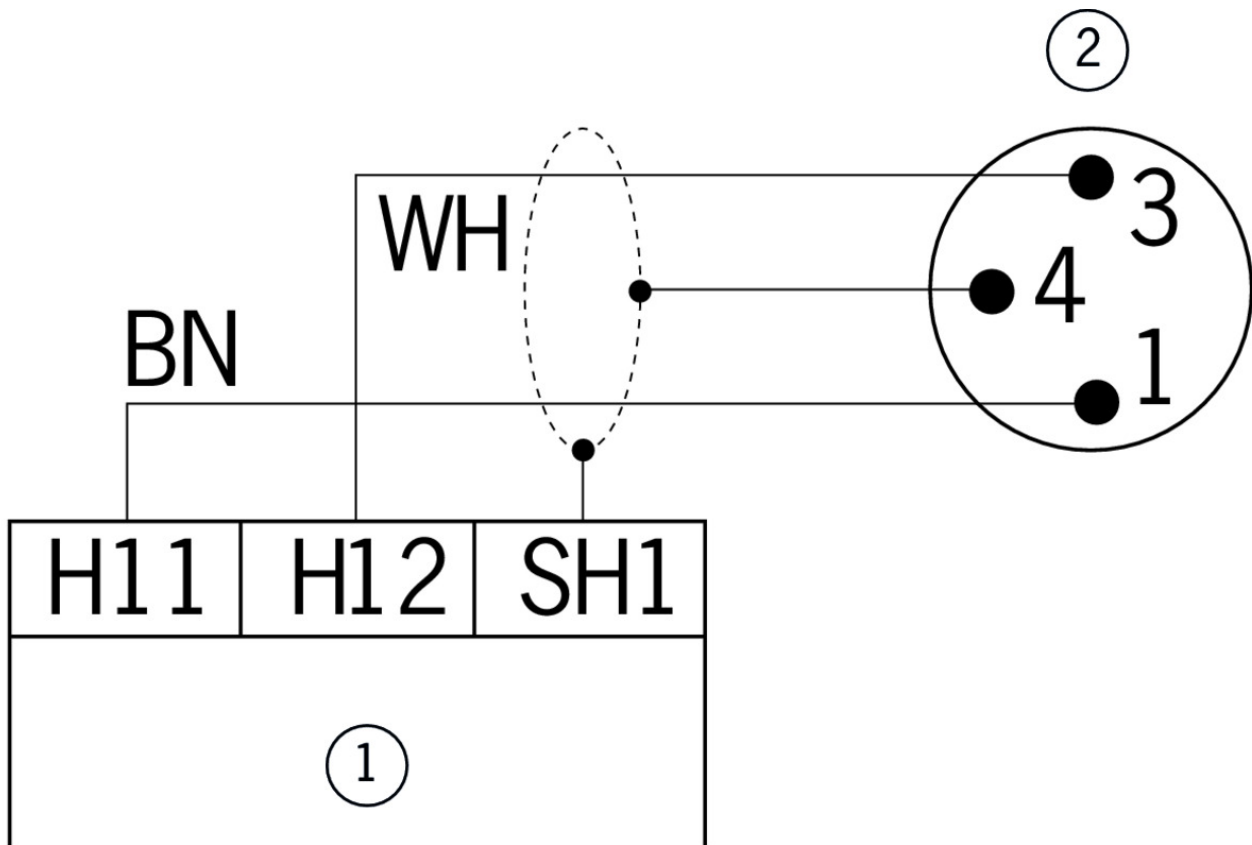

Legende

- 1 Evaluation unit CES-AZ-.ES
- 2 View of plug connector M8 for key adapter

Actuator

- ✓ Key CKS, color red



113461 CKS-A-BK1-RD-113461

Connection material

- ✓ Connection cable with plug connector M8, 3-pin, 5m



084762 C-M08F03-02X025PU05,0-ES-084762

- ✓ Features
 - › M8 female plug, 3-pin
 - › Straight plug connector
 - › PUR cable
 - › Cable length 5 m

- › With flying lead

▼ Connection cable with plug connector M8, 3-pin, 10m



084763 C-M08F03-02X025PU10,0-ES-084763

▼ Features

- › M8 female plug, 3-pin
- › Straight plug connector
- › PUR cable
- › Cable length 10 m
- › With flying lead



077767 C-M08F03-02X025PV10,0-ES-077767

▼ Features

- › M8 female plug, 3-pin
- › Straight plug connector
- › PVC cable
- › Cable length 10 m
- › With flying lead

▼ Connection cable with angled plug connector M8, 3-pin, 10m



098590 C-M08F03-02X025PU10,0-ES-098590

▼ Features

- › M8 female plug, 3-pin
- › Angled plug connector
- › PUR cable
- › Cable length 10 m
- › With flying lead



084701 C-M08F03-02X025PV10,0-ES-084701

▼ Features

- › M8 female plug, 3-pin
- › Angled plug connector
- › PVC cable
- › Cable length 10 m
- › With flying lead

▼ Connection cable with plug connector M8, 3-pin, 15m



084764 C-M08F03-02X025PU15,0-ES-084764

▼ Features

- › M8 female plug, 3-pin
- › Straight plug connector
- › PUR cable
- › Cable length 15 m
- › With flying lead

▼ Connection cable with plug connector M8, 3-pin, 20m



084765 C-M08F03-02X025PU20,0-ES-084765

- ▼ Features
 - › M8 female plug, 3-pin
 - › Straight plug connector
 - › PUR cable
 - › Cable length 20 m
 - › With flying lead
-



077716 C-M08F03-02X025PV20,0-ES-077716

- ▼ Features
 - › M8 female plug, 3-pin
 - › Straight plug connector
 - › PVC cable
 - › Cable length 20 m
 - › With flying lead
-

- ▼ Connection cable with plug connector M8, 3-pin, 25m



084766 C-M08F03-02X025PU25,0-ES-084766

- ▼ Features
 - › M8 female plug, 3-pin
 - › Straight plug connector
 - › PUR cable
 - › Cable length 25 m
 - › With flying lead
-



077717 C-M08F03-02X025PV25,0-ES-077717

- ▼ Features
 - › M8 female plug, 3-pin
 - › Straight plug connector
 - › PVC cable
 - › Cable length 25 m
 - › With flying lead
-

- ▼ Connection cable with plug connector M8, 3-pin, 3m



077935 C-M08F03-02X025PV03,0-ES-077935

- ▼ Features
 - › M8 female plug, 3-pin
 - › Straight plug connector
 - › PVC cable
 - › Cable length 3 m
 - › With flying lead
-

- ▼ Connection cable with plug connector M8, 5m



077793 C-M08F03-02X025PV05,0-ES-077793

- ▼ Features
 - › M8 female plug, 3-pin
 - › Straight plug connector
 - › PVC cable
 - › Cable length 5 m
 - › With flying lead

▼ Connection cable with angled plug connector M8, 3-pin, 25m, angled





099998 C-M08F03-02X025PV25,0-ES-099998

▼ Features

- › M8 female plug, 3-pin
- › Angled plug connector
- › PVC cable
- › Cable length 25 m
- › With flying lead





Instructions

▼ Betriebsanleitung Schlüsselaufnahme CKS-A-L1B-SC

	Doc. no.	Version	Language	Download
Betriebsanleitung Schlüsselaufnahme CKS-A-L1B-SC	113903	05-08/16	 	 0.4 MB
Operating Instructions Key Adapter CKS-A-L1B-SC				

Declaration of conformity

▼ EU-Konformitätserklärung

	Doc. no.	Version	Language	Download
EU-Konformitätserklärung	2137351	02-01/17		 0.3 MB
Declaración UE de conformidad				
Déclaration UE de conformité				
Dichiarazione di conformità				
EU declaration of conformity			