

ITEM 112602 MGB-LOHE-APA-L-112602

Description	Technical data	Accessories	Downloads
-------------	----------------	-------------	-----------

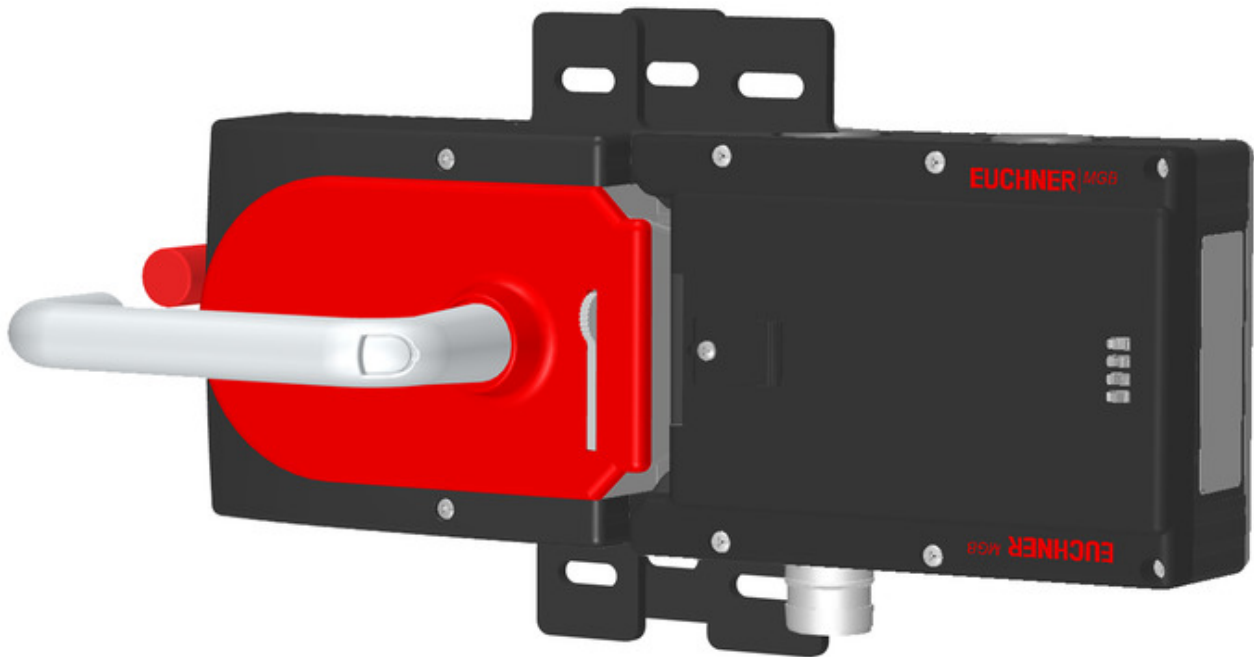

Features

- › Locking (without guard locking)
- › With plug connector RC18
- › Mounted on mounting plates
- › With escape release
- › Unicode

Guard locking type

MGB-LO... The bolt tongue in the handle module is moved into and out of the interlocking module by actuating the door handle. The door arm is not locked in the locked position.

Door hinge

A mechanical door stop is permanently integrated into the evaluation module of the MGB. A marking on the stop makes adjustment easier.

LED indicator

The LED indicator indicates all important system and status information.

Monitoring outputs

- OD** ON when the door is closed
 - OT** Bolt tongue inserted in the evaluation module
 - OI** Diagnostics; there is a fault
-

Escape release

The escape release enables persons who are accidentally locked in to open the locked door from inside the danger area.

Notice

The interlocking module, handle module and the escape release are each pre-assembled on a mounting plate.

Components included in the set



112598 Interlocking module MGB-L0-APA-AA1A2-S1-L-112598
✓ Features



111839 Handle module MGB-H-AA1A6-L-111839
✓ Features



106051 Escape release MGB-E-A2-106051
✓ Features

Dimension drawing

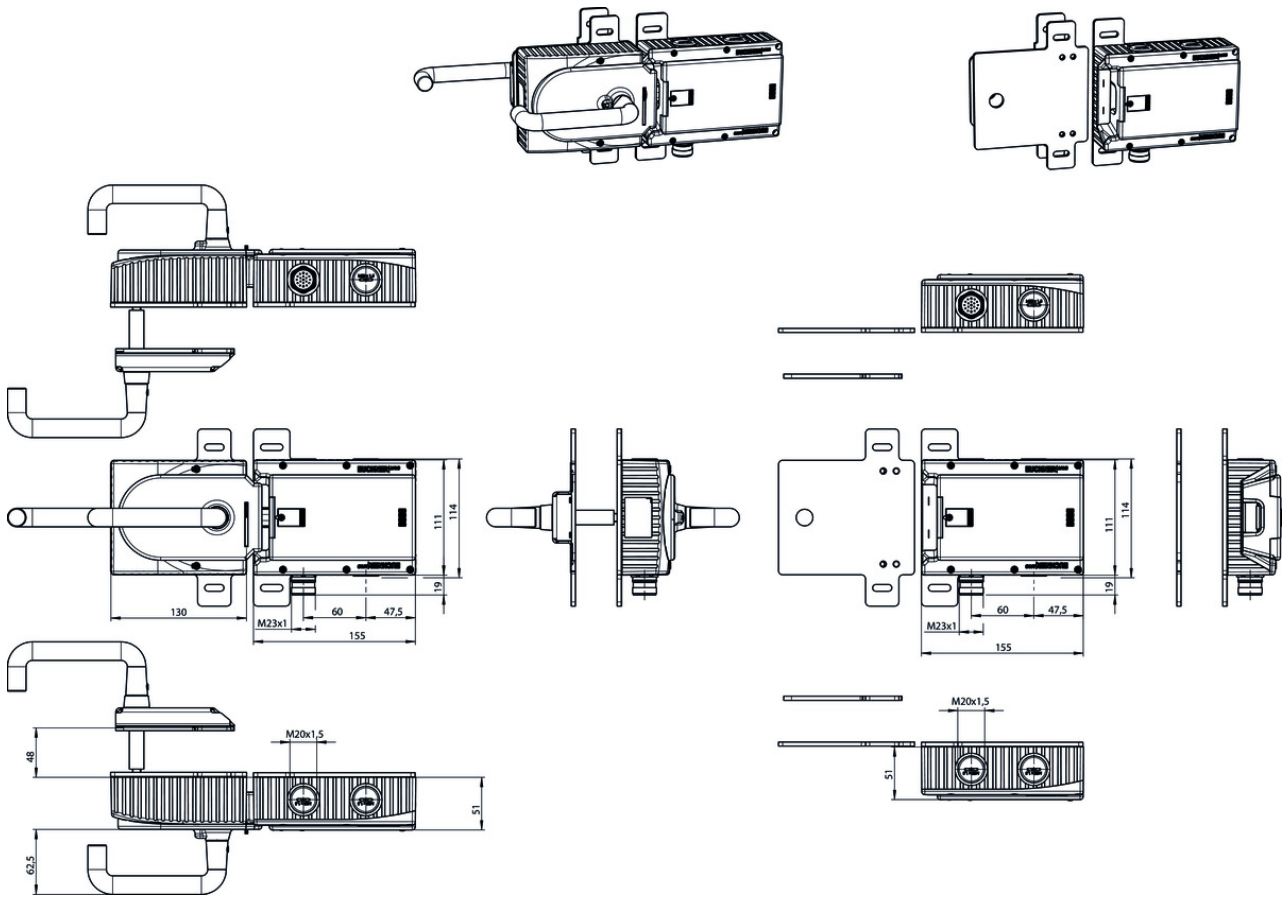

Dimension drawing

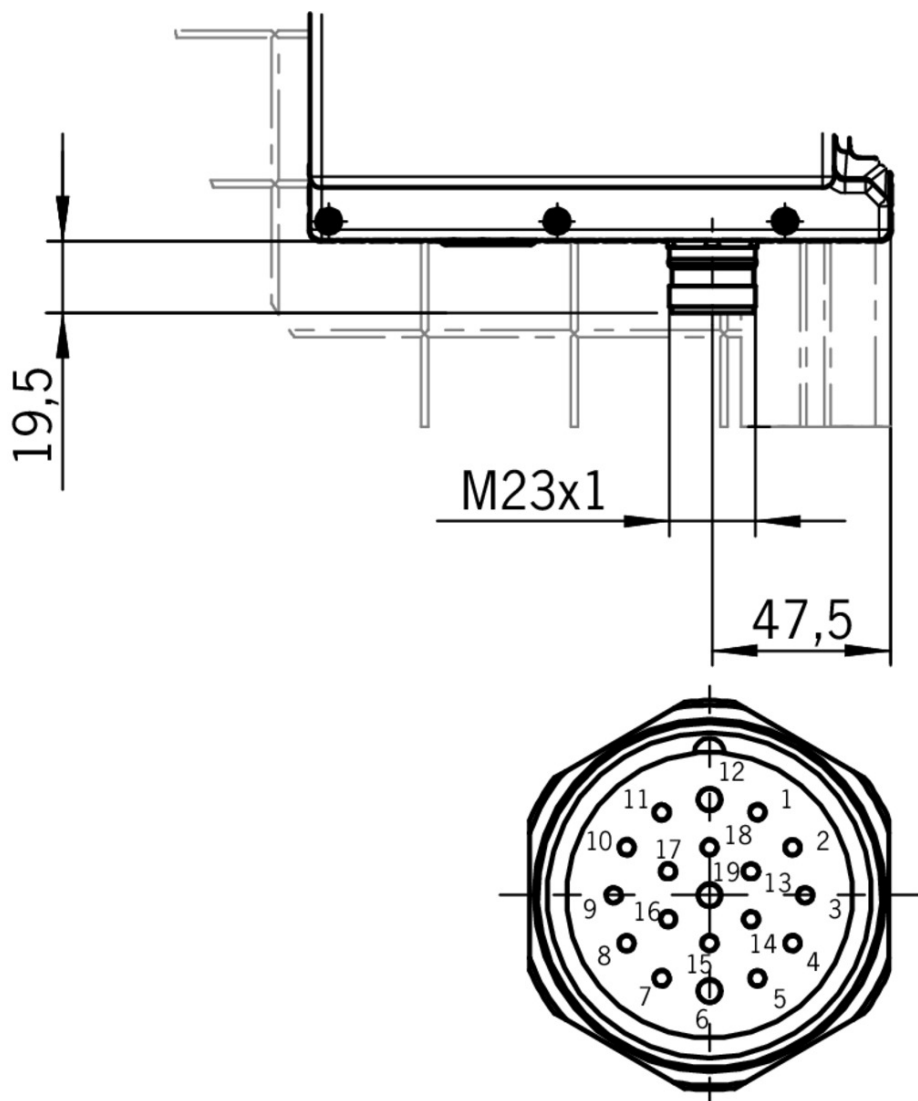

Plug connector RC18

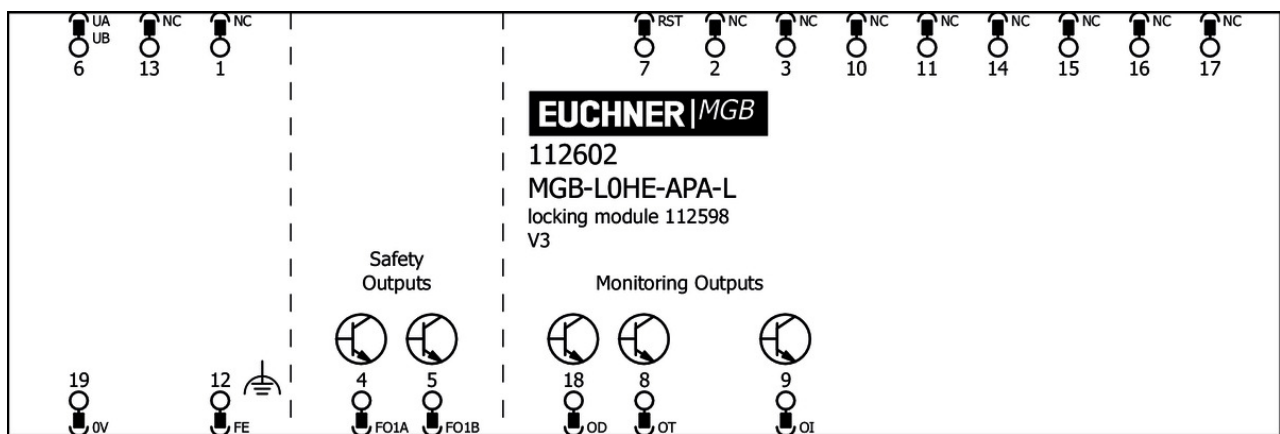

Function expansion

✓ Escape release module MGB-E... pre-assembled on mounting plate

106051 MGB-E-A2-106051



- ✔ Features
 - › Escape release out of the danger area
 - › Mounted on mounting plate
 - › With red handle
 - › 118 mm long
-

✔ Door handle for MGB-H...



110277 MGB-A-DOORHANDLE-S1-110277

- ✔ Features
 - › Aluminum silver anodized
 - › For mounting on all MGB handle modules MGB-H up to V2.0.0
-



123926 MGB-A-DOORHANDLE-S2-123926

- ✔ Features
 - › Aluminum silver anodized
 - › For mounting on all MGB handle modules MGB-H from V3.0.0
-

✔ Door knob for MGB-H...



111460 MGB-A-DOORKNOB-S1-111460

- ✔ Features
 - › Aluminum, silver anodized
 - › For mounting on all MGB handle modules MGB-H... up to V2.0.0
 - › e.g. on sliding doors
-



124030 MGB-A-DOORKNOB-S2-124030

- ✔ Features
 - › Aluminum, silver anodized
 - › For mounting on all MGB handle modules MGB-H... from V3.0.0
 - › e.g. on sliding doors
-

✔ Door handle for MGB-E...



110276 MGB-A-DOORHANDLE-R1-110276

- ✔ Features
 - › Aluminum, red painted
 - › For mounting on all MGB escape release modules MGB-E
-

✔ Door knob for MGB-E...



114904 MGB-A-DOORKNOB-R1-114904

- ✔ Features
 - › Aluminum, red painted
 - › For mounting on all MGB escape release modules MGB-E
 - › e.g. on sliding doors
-

✔ Extended actuation axis for MGB-E...

106761 AY-ERS-250-106761



Spare parts

- ▼ Handle module MGB-H... with automatically extending lockout mechanism



111839 MGB-H-AA1A6-L-111839

- ▼ Features

- › Intelligent bolt tongue
- › Fold-out lockout mechanism
- › Second automatically extending lockout mechanism
- › Door handle
- › Mounting plate

-
- ▼ Interlocking module MGB-L0-APA..., without controls or indicators, RC18, on mounting plates



112598 MGB-L0-APA-AA1A2-S1-L-112598

- ▼ Features

- › Locking (without guard locking)
- › With plug connector RC18
- › Mounted on mounting plates
- › Unicode

Connection material

- ▼ Connection cable with plug connector M23 with option C1825, 1.5m, straight



092761 C-M23F19-19XDIFPU01,5-MA-092761

- ▼ Features

- › M23 plug connector, 18-pin + PE
- › Straight plug connector
- › PUR cable
- › Cable length 1.5 m
- › With flying lead
- › Cores color-coded

-
- ▼ Connection cable with plug connector M23 with option C1825, 3m, straight



092816 C-M23F19-19XDIFPU03,0-MA-092816

- ▼ Features

- › M23 plug connector, 18-pin + PE
- › Straight plug connector
- › PUR cable
- › Cable length 3 m
- › With flying lead
- › Cores color-coded

-
- ▼ Connection cable with plug connector M23 with option C1825, 6m, straight

077014 C-M23F19-19XDIFPU06,0-MA-077014



- ▼ Features
 - › M23 plug connector, 18-pin + PE
 - › Straight plug connector
 - › PUR cable
 - › Cable length 6 m
 - › With flying lead
 - › Cores color-coded
-

- ▼ Connection cable with plug connector M23 with option C1825, 8m, straight



077015 C-M23F19-19XDIFPU08,0-MA-077015

- ▼ Features
 - › M23 plug connector, 18-pin + PE
 - › Straight plug connector
 - › PUR cable
 - › Cable length 8 m
 - › With flying lead
 - › Cores color-coded
-

- ▼ Connection cable with plug connector M23 with option C1825, 20m, straight



092726 C-M23F19-19XDIFPU20,0-MA-092726

- ▼ Features
 - › M23 plug connector, 18-pin + PE
 - › Straight plug connector
 - › PUR cable
 - › Cable length 20 m
 - › With flying lead
 - › Cores color-coded
-

- ▼ Connection cable with plug connector M23 with option C1825, 25m, straight



092727 C-M23F19-19XDIFPU25,0-MA-092727

- ▼ Features
 - › M23 plug connector, 18-pin + PE
 - › Straight plug connector
 - › PUR cable
 - › Cable length 25 m
 - › With flying lead
 - › Cores color-coded
-

- ▼ Connection cable with plug connector M23 with option C1825, 30m, straight



095993 C-M23F19-19XDIFPU30,0-MA-095993

- ▼ Features
 - › M23 plug connector, 18-pin + PE
 - › Straight plug connector
 - › PUR cable
 - › Cable length 30 m
 - › With flying lead
 - › Cores color-coded
-

- ▼ Connection cable with plug connector M23 with option C1825, 40m, straight



102490 C-M23F19-19XDIFPU40,0-MA-102490

▼ Features

- › M23 plug connector, 18-pin + PE
 - › Straight plug connector
 - › PUR cable
 - › Cable length 40 m
 - › With flying lead
 - › Cores color-coded
-

- ▼ Connection cable with plug connector M23 with option C1825, 10m, straight



092898 C-M23F19-19XDIFPU10,0-MA-092898

▼ Features

- › M23 plug connector, 18-pin + PE
 - › Straight plug connector
 - › PUR cable
 - › Cable length 10 m
 - › With flying lead
 - › Cores color-coded
-

- ▼ Connection cable with plug connector M23 with option C1825, 15m, straight



077016 C-M23F19-19XDIFPU15,0-MA-077016

▼ Features

- › M23 plug connector, 18-pin + PE
 - › Straight plug connector
 - › PUR cable
 - › Cable length 15 m
 - › With flying lead
 - › Cores color-coded
-

- ▼ Replacement crimp contacts for female connector RC18 with option C1825

094310 CRIMPKONTAKT BUCHSE RCF-C1825

▼ Features

- › 19 crimp sockets
 - › Conductor cross-section 16 x 0.25 - 0.5 mm² and 3 x 0.75 - 1 mm²
 - › For plug connector RC18..C1825
-

- ▼ Female plug RC18 straight with option C1825



077025 RC18EF-C1825

▼ Features

- › Plug connector M23, straight
 - › Number of pins: 19-pin with screen bonding clamp
-

▼ Lens set labeled



126158 AY-SET-LNS-SY03-126158



120377 AY-SET-LNS-SY01-120377



125359 AY-SET-LNS-SY02-125359

▼ Lens set 5 colors



120344 AY-SET-LNS-0001-120344

▼ Lens set 6 colors



















120378 AY-SET-LNS-0002-120378

Instructions

▼ Bezpečnostní informace (součást návodu k použití „Bezpečnostní systém MGB-AR/MGB-AP“) od V3.0.0

	Doc. no.	Version	Language	Download
Sicherheitsinformation (Teil der Betriebsanleitung Sicherheitssystem MGB-AR/MGB-AP) ab V3.0.0 Información de seguridad (parte del manual de instrucciones Sistema de seguridad MGB-AR/MGB-AP) V3.0.0 o superior Information de sécurité (partie du mode d'emploi Système de sécurité MGB-AR/MGB-AP) à partir de V3.0.0 Informazioni sulla sicurezza (Parte delle istruzioni di impiego Sistema di sicurezza MGB-AR/MGB-AP) da V3.0.0 Säkerhetsinformation (Del av instruktionsboken Säkerhetssystem MGB-AR/MGB-AP) från V3.0.0 Safety Information (Part of the Operating Instructions Safety System MGB-AR/MGB-AP) from V3.0.0	123151	01-02/15	 	0.6 MB
Bezpečnostní informace (součást návodu k použití „Bezpečnostní systém MGB-AR/MGB-AP“) od V3.0.0	123151	01-02/15		0.2 MB







Veiligheidsinformatie (Deel van de handleiding Beveiligingssysteem MGB-AR/MGB-AP) vanaf V3.0.0	123151	01-02/15		 0.2 MB
Informação de segurança (Parte do manual de instruções Sistema de segurança MGB-AR/MGB-AP) a partir de V3.0.0	123151	01-02/15		 0.2 MB
Informacje o bezpieczeństwie (Część instrukcji obsługi System bezpieczeństwa MGB-AR/MGB-AP) od V3.0.0	123151	01-02/15		 0.2 MB
安全信息 (安全系统 MGB-AR/MGB-AP使用说明书的组成部分) V3.0.0以上	123151	01-02/15		 0.3 MB
Информация о безопасности (часть инструкции по эксплуатации Предохранительная система MGB-AR/MGB-AP) с V3.0.0	123151	01-02/15		 0.3 MB
Güvenlik bilgisi (İşletim kılavuzunun parçası emniyet sistemi MGB-AR/MGB-AP) V3.0.0 ve üstü	123151	01-02/15		 0.3 MB
Bezpečnostná informácia (časť návodu na prevádzku Bezpečnostný systém MGB-AR/MGB-AP) od V3.0.0	123151	01-02/15		 0.2 MB
安全情報 MGB-AR/MGB-AP	123151	01-02/15		 0.6 MB

 **Návod k použití – bezpečnostní systémy MGB-L0...-AR.-... a MGB-L0...-AP.-... od V3.0.0**

	Doc. no.	Version	Language	Download
Betriebsanleitung MGB-L0...AR.-... und MGB-L0...AP.-... ab V3.0.0	2112657	13-05/18		 2.9 MB
Mode d'emploi MGB-L0...AR.-... et MGB-L0...AP.-... à partir de V3.0.0	2112657	13-05/18		 3.0 MB
Manual de instrucciones MGB-L0...AR.-... y MGB-L0...AP.-... V3.0.0 o superior	2112657	13-05/18		 2.9 MB
Návod k použití – bezpečnostní systémy MGB-L0...-AR.-... a MGB-L0...-AP.-... od V3.0.0	2112657	13-05/18		 3.2 MB
Operating Instructions MGB-L0...AR.-... and MGB-L0...AP.-... from V3.0.0	2112657	13-05/18		 2.9 MB
Istruzioni di impiego per MGB-L0...AR.-... e MGB-L0...AP.-... da V3.0.0	2112657	13-05/18		 2.9 MB
Instrukcja obsługi MGB-L0...AR.-... i MGB-L0...AP.-... od V3.0.0	2112657	13-05/18		 3.2 MB
Manual de instruções MGB-L0...AR.-... e MGB-L0...AP.-... a partir de V3.0.0	2112657	13-05/18		 2.9 MB
Инструкция по эксплуатации MGB-L0...AR.-... и MGB-L0...AP.-... с V3.0.0	2112657	13-05/18		 3.4 MB
Instruktionsbok MGB-L0...AR.-... och MGB-L0...AP.-... fr. V3.0.0	2112657	13-05/18		 2.9 MB
操作指示書 安全システム MGB-L0...-AR.-... および MGB-L0...-AP.-... V3.0.0以降	2112657	13-05/18		 3.3 MB
使用说明书 安全系统 MGB-L0...-AR.-...和MGB-L0...-AP.-... V3.0.0以上	2112657	13-05/18		 3.3 MB

Declaration of conformity

 EU-Konformitätserklärung

	Doc. no.	Version	Language	Download
EU-Konformitätserklärung	2123150	08-01/17		 0.3 MB
Declaración UE de conformidad				
Déclaration UE de conformité				
Dichiarazione di conformità				
EU declaration of conformity				

CAD data

CAD data for this item on TraceParts