

## ITEM 112600 MGB-LOHE-APA-R-112600

Description	Technical data	Accessories	Downloads
-------------	----------------	-------------	-----------

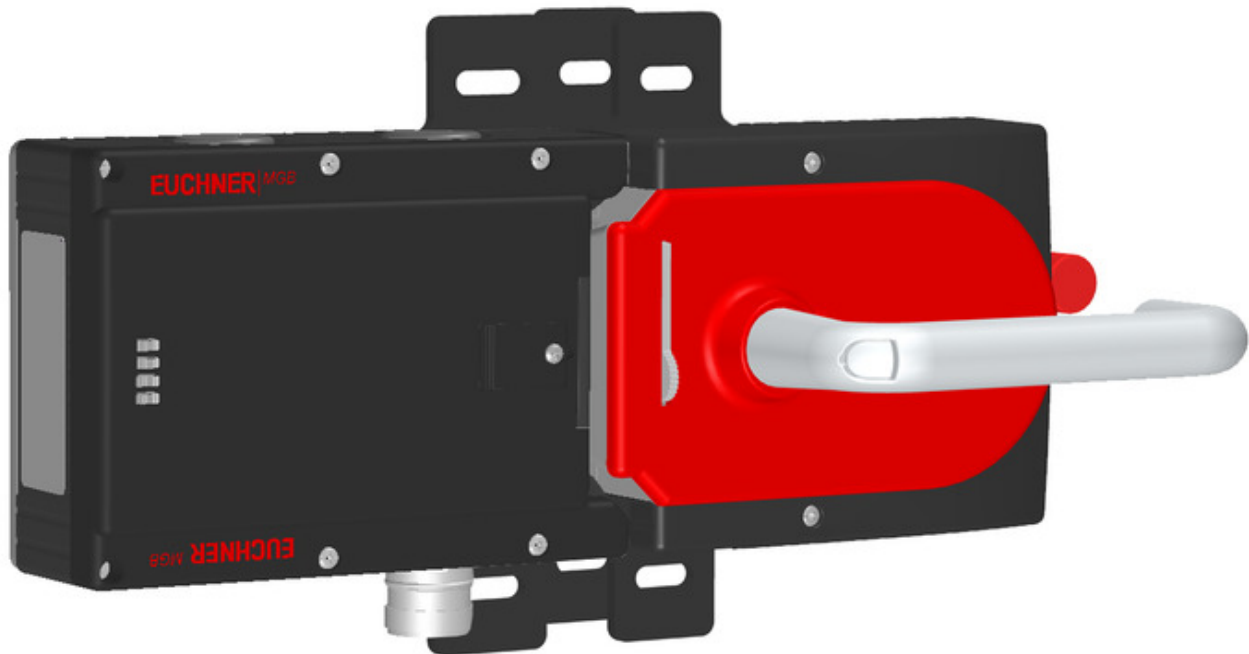

### Features

- › Locking (without guard locking)
- › With plug connector RC18
- › Mounted on mounting plates
- › With escape release
- › Unicode

### Guard locking type

**MGB-** The bolt tongue in the handle module is moved into and out of the **L0...** interlocking module by actuating the door handle. The door arm is not locked in the locked position.

### Door hinge

A mechanical door stop is permanently integrated into the evaluation module of the MGB. A marking on the stop makes adjustment easier.

### LED indicator

The LED indicator indicates all important system and status information.

## Monitoring outputs

- OD** ON when the door is closed
  - OT** Bolt tongue inserted in the evaluation module
  - OI** Diagnostics; there is a fault
- 

## Escape release

The escape release enables persons who are accidentally locked in to open the locked door from inside the danger area.

---

## Notice

The interlocking module, handle module and the escape release are each pre-assembled on a mounting plate.

## Components included in the set



112596 Interlocking module MGB-L0-APA-AA1A2-S1-R-112596  
✓ Features

---



111838 Handle module MGB-H-AA1A6-R-111838  
✓ Features

---



106051 Escape release MGB-E-A2-106051  
✓ Features

---

# Dimension drawing

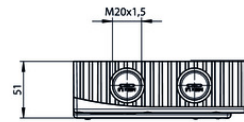
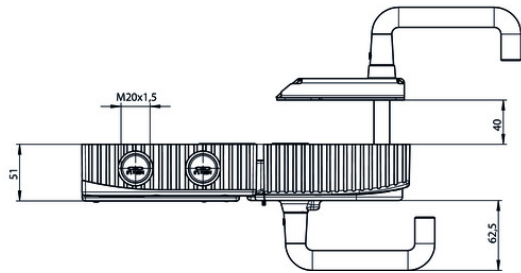
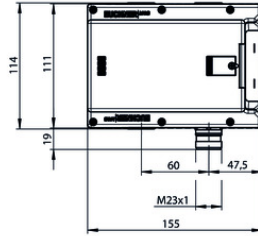
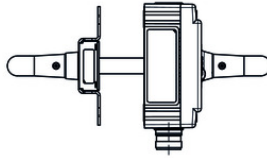
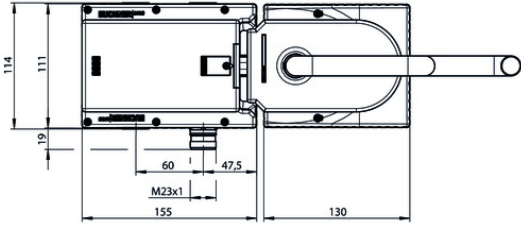
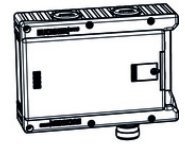
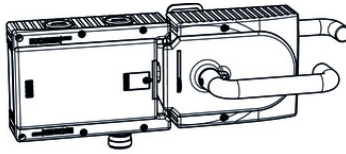
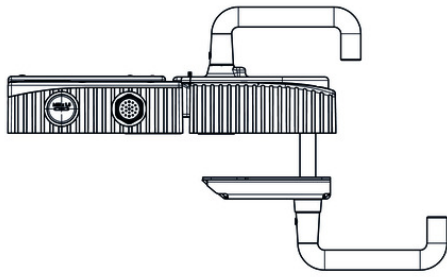

**Dimension drawing**

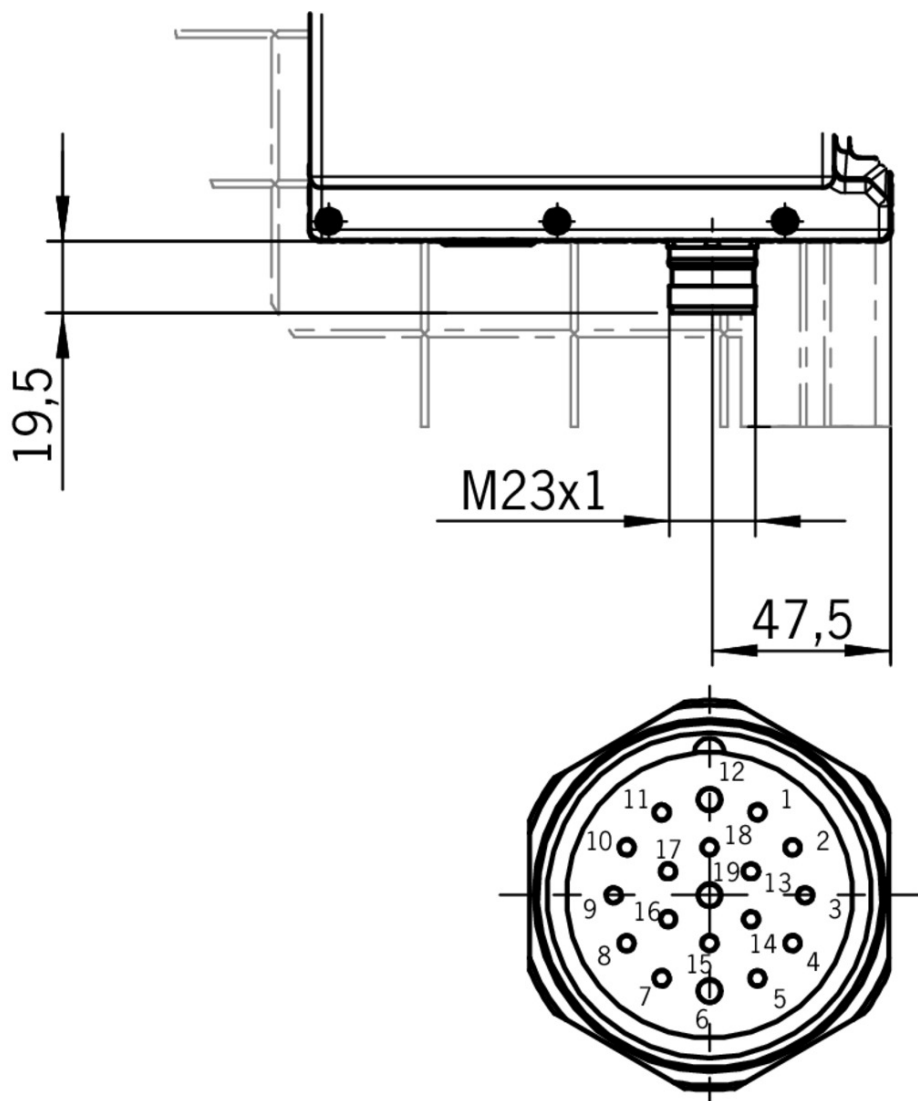

**Plug connector RC18**

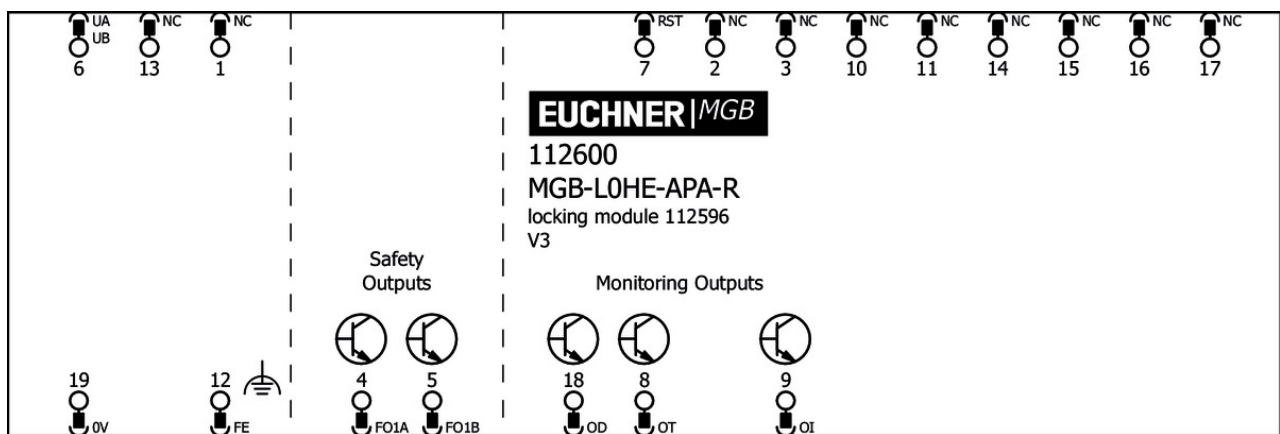

**Spare parts**

✓ Interlocking module MGB-L0-APA..., without controls or indicators, RC18, on mounting plates

**112596** MGB-L0-APA-AA1A2-S1-R-112596



- ✓ Features
    - › Locking (without guard locking)
    - › With plug connector RC18
    - › Mounted on mounting plates
    - › Unicode
- 

- ✓ Handle module MGB-H... with automatically extending lockout mechanism



- 111838** MGB-H-AA1A6-R-111838
    - ✓ Features
      - › Intelligent bolt tongue
      - › Fold-out lockout mechanism
      - › Second automatically extending lockout mechanism
      - › Door handle
      - › Mounting plate
- 

## Function expansion

---

- ✓ Escape release module MGB-E... pre-assembled on mounting plate



- 106051** MGB-E-A2-106051
    - ✓ Features
      - › Escape release out of the danger area
      - › Mounted on mounting plate
      - › With red handle
      - › 118 mm long
- 

- ✓ Door handle for MGB-H...



- 110277** MGB-A-DOORHANDLE-S1-110277
    - ✓ Features
      - › Aluminum silver anodized
      - › For mounting on all MGB handle modules MGB-H up to V2.0.0
- 



- 123926** MGB-A-DOORHANDLE-S2-123926
    - ✓ Features
      - › Aluminum silver anodized
      - › For mounting on all MGB handle modules MGB-H from V3.0.0
- 

- ✓ Door knob for MGB-H...



- 111460** MGB-A-DOORKNOB-S1-111460
    - ✓ Features
      - › Aluminum, silver anodized
      - › For mounting on all MGB handle modules MGB-H... up to V2.0.0
      - › e.g. on sliding doors
- 



- 124030** MGB-A-DOORKNOB-S2-124030
  - ✓ Features
    - › Aluminum, silver anodized

- › For mounting on all MGB handle modules MGB-H... from V3.0.0
- › e.g. on sliding doors

---

▼ Door knob for MGB-E...



**114904** MGB-A-DOORKNOB-R1-114904

▼ Features

- › Aluminum, red painted
- › For mounting on all MGB escape release modules MGB-E
- › e.g. on sliding doors

---

▼ Door handle for MGB-E...



**110276** MGB-A-DOORHANDLE-R1-110276

▼ Features

- › Aluminum, red painted
- › For mounting on all MGB escape release modules MGB-E

---

▼ Extended actuation axis for MGB-E...



**106761** AY-ERS-250-106761

---

## Connection material

▼ Connection cable with plug connector M23 with option C1825, 25m, straight



**092727** C-M23F19-19XDIFPU25,0-MA-092727

▼ Features

- › M23 plug connector, 18-pin + PE
- › Straight plug connector
- › PUR cable
- › Cable length 25 m
- › With flying lead
- › Cores color-coded

---

▼ Connection cable with plug connector M23 with option C1825, 15m, straight



**077016** C-M23F19-19XDIFPU15,0-MA-077016

▼ Features

- › M23 plug connector, 18-pin + PE
- › Straight plug connector
- › PUR cable
- › Cable length 15 m
- › With flying lead
- › Cores color-coded

---

▼ Connection cable with plug connector M23 with option C1825, 20m, straight

**092726** C-M23F19-19XDIFPU20,0-MA-092726



- ▼ Features
    - › M23 plug connector, 18-pin + PE
    - › Straight plug connector
    - › PUR cable
    - › Cable length 20 m
    - › With flying lead
    - › Cores color-coded
- 

- ▼ Connection cable with plug connector M23 with option C1825, 40m, straight



**102490** C-M23F19-19XDIFPU40,0-MA-102490

- ▼ Features
    - › M23 plug connector, 18-pin + PE
    - › Straight plug connector
    - › PUR cable
    - › Cable length 40 m
    - › With flying lead
    - › Cores color-coded
- 

- ▼ Connection cable with plug connector M23 with option C1825, 30m, straight



**095993** C-M23F19-19XDIFPU30,0-MA-095993

- ▼ Features
    - › M23 plug connector, 18-pin + PE
    - › Straight plug connector
    - › PUR cable
    - › Cable length 30 m
    - › With flying lead
    - › Cores color-coded
- 

- ▼ Connection cable with plug connector M23 with option C1825, 10m, straight



**092898** C-M23F19-19XDIFPU10,0-MA-092898

- ▼ Features
    - › M23 plug connector, 18-pin + PE
    - › Straight plug connector
    - › PUR cable
    - › Cable length 10 m
    - › With flying lead
    - › Cores color-coded
- 

- ▼ Connection cable with plug connector M23 with option C1825, 8m, straight



**077015** C-M23F19-19XDIFPU08,0-MA-077015

- ▼ Features
    - › M23 plug connector, 18-pin + PE
    - › Straight plug connector
    - › PUR cable
    - › Cable length 8 m
    - › With flying lead
    - › Cores color-coded
-

- ▼ Connection cable with plug connector M23 with option C1825, 6m, straight



**077014** C-M23F19-19XDIFPU06,0-MA-077014

▼ Features

- › M23 plug connector, 18-pin + PE
  - › Straight plug connector
  - › PUR cable
  - › Cable length 6 m
  - › With flying lead
  - › Cores color-coded
- 

- ▼ Connection cable with plug connector M23 with option C1825, 3m, straight



**092816** C-M23F19-19XDIFPU03,0-MA-092816

▼ Features

- › M23 plug connector, 18-pin + PE
  - › Straight plug connector
  - › PUR cable
  - › Cable length 3 m
  - › With flying lead
  - › Cores color-coded
- 

- ▼ Connection cable with plug connector M23 with option C1825, 1.5m, straight



**092761** C-M23F19-19XDIFPU01,5-MA-092761

▼ Features

- › M23 plug connector, 18-pin + PE
  - › Straight plug connector
  - › PUR cable
  - › Cable length 1.5 m
  - › With flying lead
  - › Cores color-coded
- 

- ▼ Female plug RC18 straight with option C1825



**077025** RC18EF-C1825

▼ Features

- › Plug connector M23, straight
  - › Number of pins: 19-pin with screen bonding clamp
- 

- ▼ Replacement crimp contacts for female connector RC18 with option C1825

**094310** CRIMPKONTAKT BUCHSE RCF-C1825

▼ Features

- › 19 crimp sockets
  - › Conductor cross-section 16 x 0.25 - 0.5 mm<sup>2</sup> and 3 x 0.75 - 1 mm<sup>2</sup>
  - › For plug connector RC18..C1825
-



---

▼ Mounting plate for evaluation modules MGB-L.-AR.-... and MGB-L.-AP.-...



**109490** MGB-A-MOUNTINGPLATE-L-109490

▼ Features

- › Easy and quick mounting (only two screws required)
  - › Quick module replacement
  - › Steel, powder-coated
  - › Suitable for doors hinged on the right or left
- 

▼ Mounting plate for all MGB handle modules



**109491** MGB-A-MOUNTINGPLATE-H-109491

▼ Features

- › Easy and quick mounting (only two screws required)
  - › Quick module replacement
  - › Steel, powder-coated
  - › Suitable for doors hinged on the right or left
- 

▼ Mounting plate for escape release



**109492** MGB-A-MOUNTINGPLATE-E-109492

▼ Features

- › Easy and quick mounting (only two screws required)
  - › Quick module replacement
  - › Steel, powder-coated
  - › Suitable for doors hinged on the right or left
- 

## Miscellaneous accessories

---

▼ Lens set 5 colors



**120344** AY-SET-LNS-0001-120344

---

▼ Lens set 6 colors



**120378** AY-SET-LNS-0002-120378

---

▼ Lens set labeled



**120377** AY-SET-LNS-SY01-120377

---



**125359** AY-SET-LNS-SY02-125359

---



**126158** AY-SET-LNS-SY03-126158

---

























## Instructions

☑ Návod k použití – bezpečnostní systémy MGB-L0...-AR.-... a MGB-L0...-AP.-... od V3.0.0

	Doc. no.	Version	Language	Download
Betriebsanleitung MGB-L0...AR.-... und MGB-L0...AP.-... ab V3.0.0	2112657	13-05/18		 2.9 MB
Mode d'emploi MGB-L0...AR.-... et MGB-L0...AP.-... à partir de V3.0.0	2112657	13-05/18		 3.0 MB
Manual de instrucciones MGB-L0...AR.-... y MGB-L0...AP.-... V3.0.0 o superior	2112657	13-05/18		 2.9 MB
Návod k použití – bezpečnostní systémy MGB-L0...-AR.-... a MGB-L0...-AP.-... od V3.0.0	2112657	13-05/18		 3.2 MB
Operating Instructions MGB-L0...AR.-... and MGB-L0...AP.-... from V3.0.0	2112657	13-05/18		 2.9 MB
Istruzioni di impiego per MGB-L0...AR.-... e MGB-L0...AP.-... da V3.0.0	2112657	13-05/18		 2.9 MB
Instrukcja obsługi MGB-L0...AR.-... i MGB-L0...AP.-... od V3.0.0	2112657	13-05/18		 3.2 MB
Manual de instruções MGB-L0...AR.-... e MGB-L0...AP.-... a partir de V3.0.0	2112657	13-05/18		 2.9 MB
Инструкция по эксплуатации MGB-L0...AR.-... и MGB-L0...AP.-... с V3.0.0	2112657	13-05/18		 3.4 MB
Instruktionsbok MGB-L0...AR.-... och MGB-L0...AP.-... fr. V3.0.0	2112657	13-05/18		 2.9 MB
操作指示書 安全システム MGB-L0...-AR.-... および MGB-L0...-AP.-... V3.0.0以降	2112657	13-05/18		 3.3 MB
使用说明书 安全系统 MGB-L0...-AR.-...和MGB-L0...-AP.-... V3.0.0以上	2112657	13-05/18		 3.3 MB







☑ Sicherheitsinformation (Teil der Betriebsanleitung Sicherheitssystem MGB-AR/MGB-AP) ab V3.0.0

Doc. no. Version Language Download

Sicherheitsinformation (Teil der Betriebsanleitung Sicherheitssystem MGB-AR/MGB-AP) ab V3.0.0 Información de seguridad (parte del manual de instrucciones Sistema de seguridad MGB-AR/MGB-AP) V3.0.0 o superior Information de sécurité (partie du mode d'emploi Système de sécurité MGB-AR/MGB-AP) à partir de V3.0.0 Informazioni sulla sicurezza (Parte delle istruzioni di impiego Sistema di sicurezza MGB-AR/MGB-AP) da V3.0.0 Säkerhetsinformation (Del av instruktionsboken Säkerhetssystem MGB-AR/MGB-AP) från V3.0.0 Safety Information (Part of the Operating Instructions Safety System MGB-AR/MGB-AP) from V3.0.0	123151	01-02/15	     	 0.6 MB
Veiligheidsinformatie (Deel van de handleiding Beveiligingssysteem MGB-AR/MGB-AP) vanaf V3.0.0	123151	01-02/15		 0.2 MB
Информация о безопасности (часть инструкции по эксплуатации Предохранительная система MGB-AR/MGB-AP) с V3.0.0	123151	01-02/15		 0.3 MB
Informação de segurança (Parte do manual de instruções Sistema de segurança MGB-AR/MGB-AP) a partir de V3.0.0	123151	01-02/15		 0.2 MB
Bezpečnostní informace (součást návodu k použití „Bezpečnostní systém MGB-AR/MGB-AP“) od V3.0.0	123151	01-02/15		 0.2 MB
Informacje o bezpieczeństwie (Część instrukcji obsługi System bezpieczeństwa MGB-AR/MGB-AP) od V3.0.0	123151	01-02/15		 0.2 MB
Bezpečnostná informácia (časť návodu na prevádzku Bezpečnostný systém MGB-AR/MGB-AP) od V3.0.0	123151	01-02/15		 0.2 MB
Güvenlik bilgisi (İşletim kılavuzunun parçası emniyet sistemi MGB-AR/MGB-AP) V3.0.0 ve üstü	123151	01-02/15		 0.3 MB
安全信息 (安全系统 MGB-AR/MGB-AP使用说明书的组成部分) V3.0.0以上	123151	01-02/15		 0.3 MB
安全情報 MGB-AR/MGB-AP	123151	01-02/15		 0.6 MB

## Declaration of conformity

### EU-Konformitätserklärung

	Doc. no.	Version	Language	Download
EU-Konformitätserklärung Declaración UE de conformidad Déclaration UE de conformité Dichiarazione di conformità EU declaration of conformity	2123150	08-01/17	    	 0.3 MB

## CAD data

CAD data for this item on TraceParts