

ITEM 115178 MGB-L1H-APA-R-115178

| Description | Technical data | Accessories | Downloads |
|-------------|----------------|-------------|-----------|
|-------------|----------------|-------------|-----------|

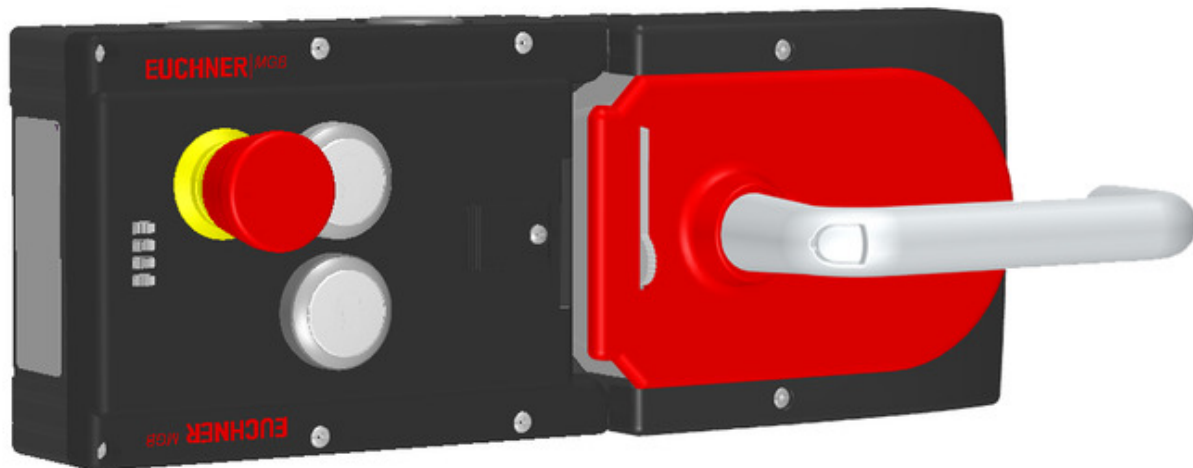

Features

- › Guard locking with guard lock monitoring
- › Emergency stop according to ISO 13850
- › 1 pushbutton (illuminated, with symbol "Unlocked", wh)
- › 1 pushbutton (illuminated, with symbol "Locked", wh)
- › With cable entry
- › Unicode

Guard locking type

MGB- The locking arm is held in the locked position by spring force and is
L1... unlocked by solenoid force (closed-circuit current principle, mechanically locked).

Door hinge

A mechanical door stop is permanently integrated into the evaluation module of the MGB. A marking on the stop makes adjustment easier.

LED indicator

The LED indicator indicates all important system and status information.

Monitoring outputs

- OD** ON when the door is closed
 - OT** Bolt tongue inserted in the evaluation module
 - OL** Guard locking solenoid in locked position
 - OI** Diagnostics; there is a fault
-

Emergency stop device

- S1** 2 positively driven NC contacts and 1 NO contact (e.g. monitoring contact), emergency stop with turn-to-reset, not illuminated
-

Pushbutton

- S2** 1 NO contact, white, illuminated (symbol: Unlocked)
- S3** 1 NO contact, white, illuminated (symbol: Locked)

Components included in the set



115224 Locking module MGB-L1-APA-AG2A1-M-115224
Features



100464 Handle module MGB-H-AA1A1-R-100464
Features

Dimension drawing

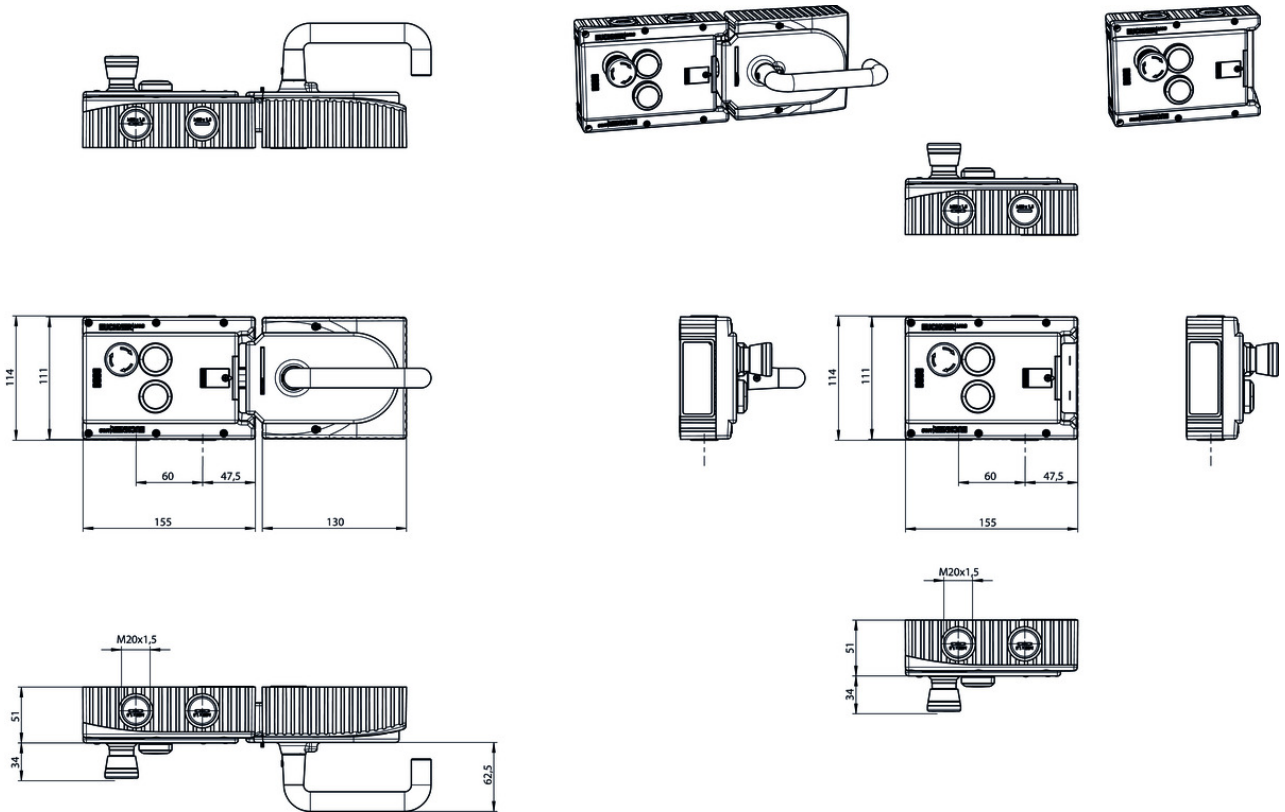

Cable entry

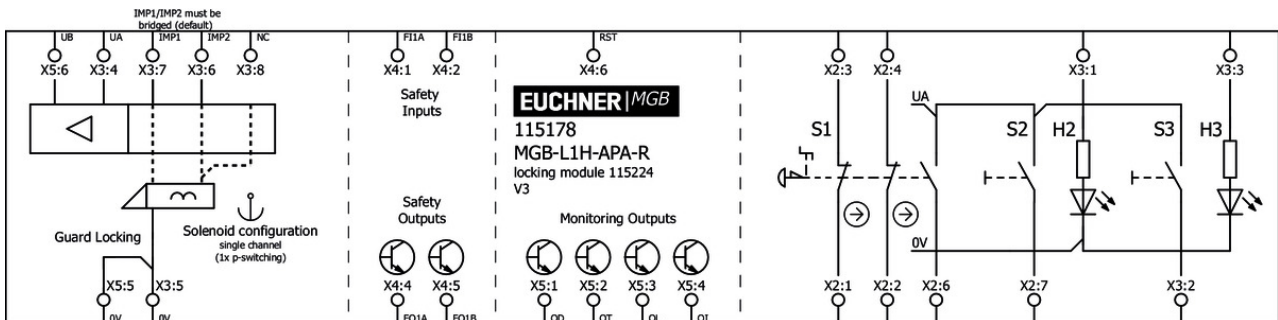

Function expansion

Emergency unlocking for safety system MGB



112989 MGB-A-EMERGENCYRELEASE-112989

Features

- › Quick emergency unlocking
- › sealable

Door knob for MGB-H...



111460 MGB-A-DOORKNOB-S1-111460

Features

- › Aluminum, silver anodized

- › For mounting on all MGB handle modules MGB-H... up to V2.0.0
- › e.g. on sliding doors



124030 MGB-A-DOORKNOB-S2-124030

✓ Features

- › Aluminum, silver anodized
- › For mounting on all MGB handle modules MGB-H... from V3.0.0
- › e.g. on sliding doors

✓ Door handle for MGB-H...



110277 MGB-A-DOORHANDLE-S1-110277

✓ Features

- › Aluminum silver anodized
- › For mounting on all MGB handle modules MGB-H up to V2.0.0



123926 MGB-A-DOORHANDLE-S2-123926

✓ Features

- › Aluminum silver anodized
- › For mounting on all MGB handle modules MGB-H from V3.0.0

✓ Escape release MGB-E-A...



100465 MGB-E-A-100465

✓ Features

- › Escape release from the danger zone
- › Door handle signal red
- › Extended actuation axis for thicker doors (available optionally)

Mounting accessories

✓ Mounting plate for evaluation modules MGB-L.-AR.-... and MGB-L.-AP.-...



109490 MGB-A-MOUNTINGPLATE-L-109490

✓ Features

- › Easy and quick mounting (only two screws required)
- › Quick module replacement
- › Steel, powder-coated
- › Suitable for doors hinged on the right or left

✓ Mounting plate for all MGB handle modules



109491 MGB-A-MOUNTINGPLATE-H-109491

✓ Features

- › Easy and quick mounting (only two screws required)
- › Quick module replacement
- › Steel, powder-coated
- › Suitable for doors hinged on the right or left

Spare parts

▼ Handle module MGB-H-...



100464 MGB-H-AA1A1-R-100464

▼ Features

- › Intelligent bolt tongue
 - › Lockout bar
 - › Door handle
-

▼ Locking module MGB-L1-APA..., (guard locking by spring force) with 2 push buttons, emergency stop



115224 MGB-L1-APA-AG2A1-M-115224

▼ Features

- › Guard locking with guard lock monitoring
 - › Emergency stop according to ISO 13850
 - › 1 pushbutton (illuminated, with symbol "Unlocked", wh)
 - › 1 pushbutton (illuminated, with symbol "Locked", wh)
 - › With cable entry
 - › Unicode
-

Miscellaneous accessories

▼ Lens set 5 colors



120344 AY-SET-LNS-0001-120344

▼ Lens set 6 colors



120378 AY-SET-LNS-0002-120378

▼ Lens set labeled



120377 AY-SET-LNS-SY01-120377



125359 AY-SET-LNS-SY02-125359



126158 AY-SET-LNS-SY03-126158



▼ Lens set, three colors



























158307 AY-SET-LNS-SY04-158307

Instructions

- ▼ Návod k použití – bezpečnostní systémy MGB-L1...AR-... / MGB-L2...AR-... a MGB-L1...AP-... / MGB-L2...AP-... od V3.0.0





| | Doc. no. | Version | Language | Download |
|---|----------|----------|---|--|
| Betriebsanleitung MGB-L1...AR-... / MGB-L2...AR-... und MGB-L1...AP-... / MGB-L2...AP-... ab V3.0.0 | 2119167 | 04-05/18 |  |  3.7 MB |
| Mode d'emploi MGB-L1...AR-... / MGB-L2...AR-... et MGB-L1...AP-... / MGB-L2...AP-... à partir de V3.0.0 | 2119167 | 04-05/18 |  |  3.7 MB |
| Manual de instrucciones MGB-L1...AR-... / MGB-L2...AR-... y MGB-L1...AP-... / MGB-L2...AP-... V3.0.0 o superior | 2119167 | 04-05/18 |  |  3.7 MB |
| Návod k použití – bezpečnostní systémy MGB-L1...AR-... / MGB-L2...AR-... a MGB-L1...AP-... / MGB-L2...AP-... od V3.0.0 | 2119167 | 04-05/18 |  |  4.0 MB |
| Operating Instructions MGB-L1...AR-... / MGB-L2...AR-... and MGB-L1...AP-... / MGB-L2...AP-... from V3.0.0 | 2119167 | 04-05/18 |  |  3.7 MB |
| Istruzioni di impiego MGB-L1...AR-... / MGB-L2...AR-... und MGB-L1...AP-... / MGB-L2...AP-... da V3.0.0 | 2119167 | 04-05/18 |  |  3.7 MB |
| Handleiding MGB-L1...AR-... / MGB-L2...AR-... en MGB-L1...AP-... / MGB-L2...AP-... vanaf V3.0.0 | 2119167 | 04-05/18 |  |  3.7 MB |
| Instrukcja obsługi MGB-L1...AR-... / MGB-L2...AR-... i MGB-L1...AP-... / MGB-L2...AP-... od V3.0.0 | 2119167 | 04-05/18 |  |  4.0 MB |
| Manual de instruções MGB-L1...AR-... / MGB-L2...AR-... e MGB-L1...AP-... / MGB-L2...AP-... a partir de V3.0.0 | 2119167 | 04-05/18 |  |  3.7 MB |
| Инструкция по эксплуатации MGB-L1...AR-... / MGB-L2...AR-... и MGB-L1...AP-... / MGB-L2...AP-... с V3.0.0 | 2119167 | 04-05/18 |  |  4.2 MB |
| Návod na prevádzku Bezpečnostné systémy MGB-L1...AR-... / MGB-L2...AR-... a MGB-L1...AP-... / MGB-L2...AP-... od V3.0.0 | 2119167 | 04-05/18 |  |  4.0 MB |
| Instruktionsbok MGB-L1...AR-... / MGB-L2...AR-... och MGB-L1...AP-... / MGB-L2...AP-... fr. V3.0.0 | 2119167 | 04-05/18 |  |  3.7 MB |
| İşletim kılavuzu MGB-L1...AR-... / MGB-L2...AR-... ve MGB-L1...AP-... / MGB-L2...AP-... itibaren V3.0.0 | 2119167 | 04-05/18 |  |  4.1 MB |
| 操作指示書 安全システム MGB-L1...-AR-... / MGB-L2...-AR-... および MGB-L1...-AP-... / MGB-L2...-AP-... V3.0.0以降 | 2119167 | 04-05/18 |  |  4.1 MB |
| 使用说明书 安全系统 MGB-L1...-AR-... / MGB-L2...-AR-...和MGB-L1...-AP-... / MGB-L2...-AP-... V3.0.0以上 | 2119167 | 04-05/18 |  |  4.1 MB |

☑ Veiligheidsinformatie (Deel van de handleiding Beveiligingssysteem MGB-AR/MGB-AP) vanaf V3.0.0

| | Doc. no. | Version | Language | Download |
|---|----------|----------|--|--|
| Sicherheitsinformation (Teil der Betriebsanleitung Sicherheitssystem MGB-AR/MGB-AP) ab V3.0.0 Información de seguridad (parte del manual de instrucciones Sistema de seguridad MGB-AR/MGB-AP) V3.0.0 o superior Information de sécurité (partie du mode d'emploi Système de sécurité MGB-AR/MGB-AP) à partir de V3.0.0 Informazioni sulla sicurezza (Parte delle istruzioni di impiego Sistema di sicurezza MGB-AR/MGB-AP) da V3.0.0 Säkerhetsinformation (Del av instruktionsboken Säkerhetssystem MGB-AR/MGB-AP) från V3.0.0 Safety Information (Part of the Operating Instructions Safety System MGB-AR/MGB-AP) from V3.0.0 | 123151 | 01-02/15 |       |  0.6 MB |
| Veiligheidsinformatie (Deel van de handleiding Beveiligingssysteem MGB-AR/MGB-AP) vanaf V3.0.0 | 123151 | 01-02/15 |  |  0.2 MB |
| Informação de segurança (Parte do manual de instruções Sistema de segurança MGB-AR/MGB-AP) a partir de V3.0.0 | 123151 | 01-02/15 |  |  0.2 MB |
| Bezpečnostní informace (součást návodu k použití „Bezpečnostní systém MGB-AR/MGB-AP“) od V3.0.0 | 123151 | 01-02/15 |  |  0.2 MB |
| Informacje o bezpieczeństwie (Część instrukcji obsługi System bezpieczeństwa MGB-AR/MGB-AP) od V3.0.0 | 123151 | 01-02/15 |  |  0.2 MB |
| Bezpečnostná informácia (časť návodu na prevádzku Bezpečnostný systém MGB-AR/MGB-AP) od V3.0.0 | 123151 | 01-02/15 |  |  0.2 MB |
| Güvenlik bilgisi (İşletim kılavuzunun parçası emniyet sistemi MGB-AR/MGB-AP) V3.0.0 ve üstü | 123151 | 01-02/15 |  |  0.3 MB |
| Информация о безопасности (часть инструкции по эксплуатации Предохранительная система MGB-AR/MGB-AP) с V3.0.0 | 123151 | 01-02/15 |  |  0.3 MB |
| 安全信息 (安全系统 MGB-AR/MGB-AP使用说明书的组成部分) V3.0.0以上 | 123151 | 01-02/15 |  |  0.3 MB |
| 安全情報 MGB-AR/MGB-AP | 123151 | 01-02/15 |  |  0.6 MB |

Catalogs





☑ Multifunctional Gate Box MGB Multifunctional Gate Box MGB Multifunctional Gate Box MGB Multifunctional Gate Box MGB Multifunctional Gate Box MGB 多功能系统安全控制系统 MGB

| | Doc. no. | Version | Language | Download |
|------------------------------|----------|----------|---|--|
| Multifunctional Gate Box MGB | 106108 | 10-02/18 |  |  8.2 MB |
| Multifunctional Gate Box MGB | 109155 | 10-02/18 |  |  8.2 MB |

| | | | | |
|------------------------------|--------|----------|---|--|
| Multifunctional Gate Box MGB | 114433 | 10-02/18 |  |  8.3 MB |
| Multifunctional Gate Box MGB | 121652 | 10-02/18 |  |  8.0 MB |
| Multifunctional Gate Box MGB | 106109 | 10-02/18 |  |  8.2 MB |
| 多功能系统安全控制系统 MGB | 155883 | 10-02/18 |  |  8.3 MB |

Declaration of conformity

EU-Konformitätserklärung

| | Doc. no. | Version | Language | Download |
|-------------------------------|----------|----------|---|--|
| EU-Konformitätserklärung | 2123150 | 08-01/17 |  |  0.3 MB |
| Declaración UE de conformidad | | |  | |
| Déclaration UE de conformité | | |  | |
| Dichiarazione di conformità | | |  | |
| EU declaration of conformity | | |  | |