

ITEM 121369 MGB-L1H-APA-R-121369

Description	Technical data	Accessories	Downloads
-------------	----------------	-------------	-----------

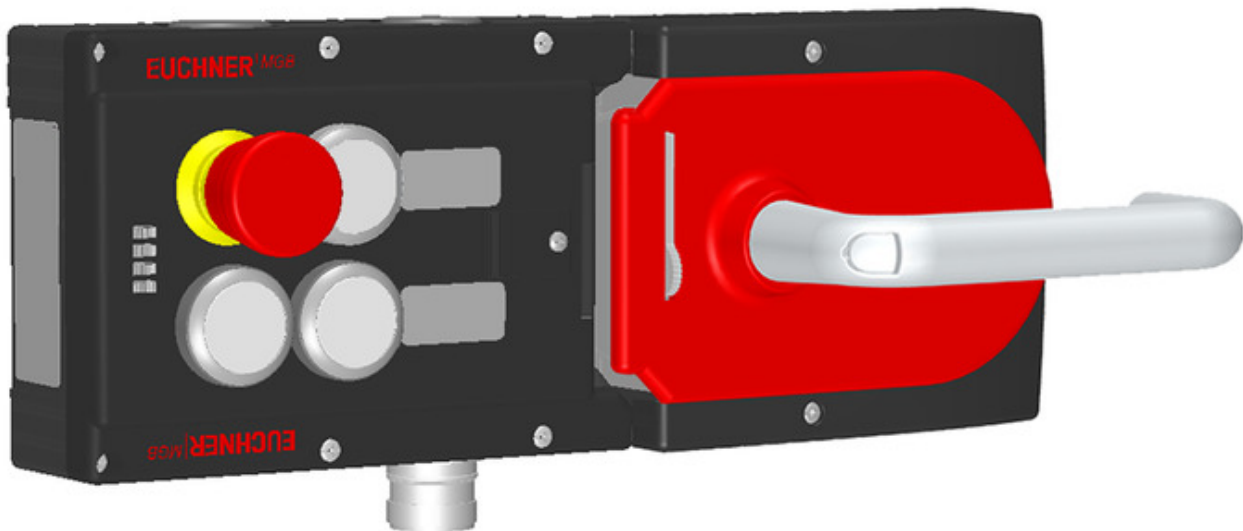

Features

- › Guard locking with guard locking monitoring
- › Emergency stop according to ISO 13850
- › Three pushbuttons (illuminated)
- › With lens set, six pcs.
- › With plug connector RC18
- › Unicode

Guard locking type

MGB- The locking arm is held in the locked position by spring force and is
L1... unlocked by solenoid force (closed-circuit current principle, mechanically locked).

Door stop

A mechanical door stop is permanently integrated into the evaluation module of the MGB. A marking on the stop makes adjustment easier.

LED indicator

The LED indicator indicates all important system and status information.

Monitoring outputs

- OT** Bolt tongue inserted in the evaluation module
 - OI** Diagnostics; there is a fault
-

Emergency stop device

- S1** Two positively driven contacts, emergency stop with turn-to-reset, not illuminated
-

Pushbutton

- S2** One NO contact, illuminated
 - S3** One NO contact, illuminated
 - S4** One NO contact, illuminated
-

Lens set

The color of the pushbutton can be selected using the lens set included (five colors). Item no.: 120344 (see Accessories)

Components included in the set



121368 Locking module MGB-L1-APA-AP4A1-S1-R-121368
Features



100464 Handle module MGB-H-AA1A1-R-100464
Features

Dimension drawing

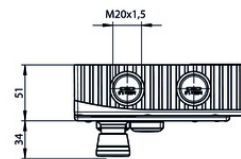
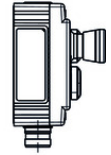
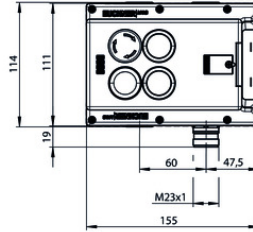
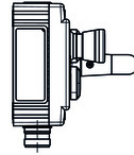
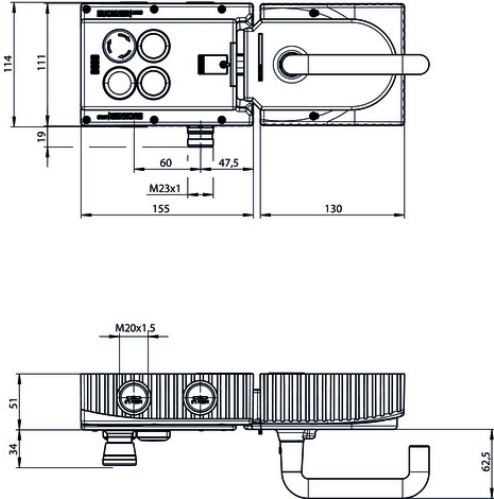
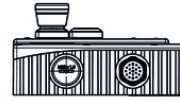
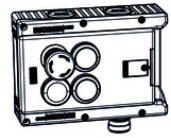
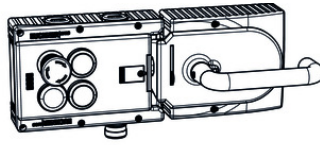
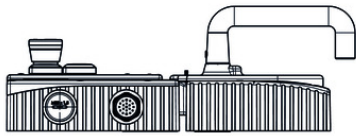

Dimension drawing

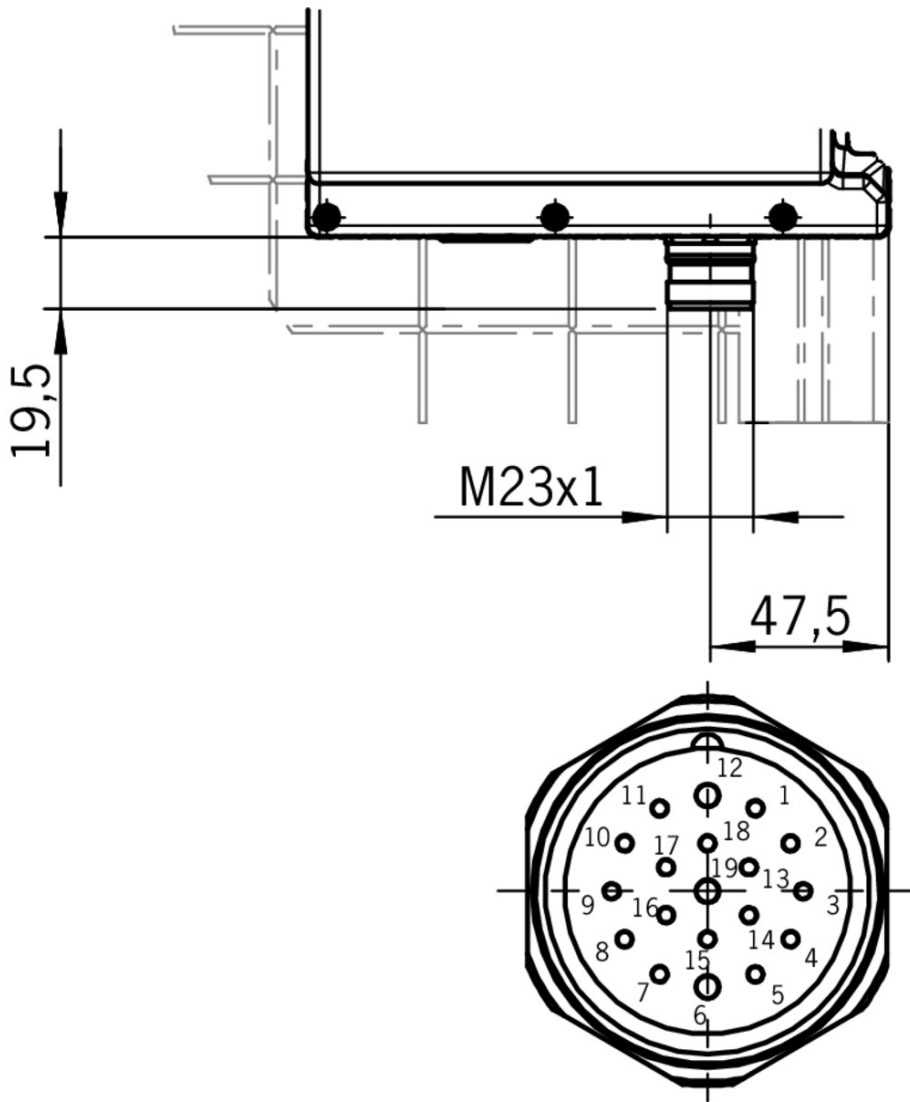

Plug connector RC18

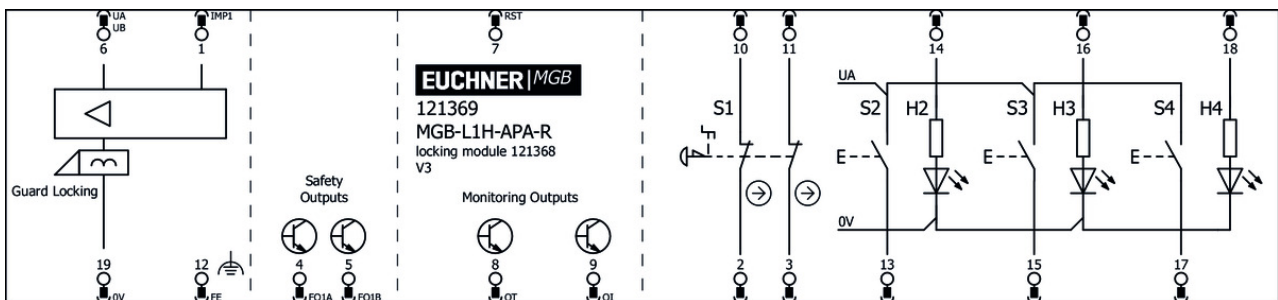

Connection material

✓ Female plug RC18 straight with option C1825



077025 RC18EF-C1825

✓ Features

- › Plug connector M23, straight
- › Number of pins: 19-pin with screen bonding clamp

-
- ▼ Replacement crimp contacts for female connector RC18 with option C1825

094310 CRIMPKONTAKT BUCHSE RCF-C1825

▼ Features

- › 19 crimp sockets
 - › Conductor cross-section 16 x 0.25 - 0.5 mm² and 3 x 0.75 - 1 mm²
 - › For plug connector RC18..C1825
-

- ▼ Connection cable with plug connector M23 with option C1825, 1.5m, straight



092761 C-M23F19-19XDIFPU01,5-MA-092761

▼ Features

- › M23 plug connector, 18-pin + PE
 - › Straight plug connector
 - › PUR cable
 - › Cable length 1.5 m
 - › With flying lead
 - › Cores color-coded
-

- ▼ Connection cable with plug connector M23 with option C1825, 3m, straight



092816 C-M23F19-19XDIFPU03,0-MA-092816

▼ Features

- › M23 plug connector, 18-pin + PE
 - › Straight plug connector
 - › PUR cable
 - › Cable length 3 m
 - › With flying lead
 - › Cores color-coded
-

- ▼ Connection cable with plug connector M23 with option C1825, 6m, straight



077014 C-M23F19-19XDIFPU06,0-MA-077014

▼ Features

- › M23 plug connector, 18-pin + PE
 - › Straight plug connector
 - › PUR cable
 - › Cable length 6 m
 - › With flying lead
 - › Cores color-coded
-

- ▼ Connection cable with plug connector M23 with option C1825, 8m, straight



077015 C-M23F19-19XDIFPU08,0-MA-077015

▼ Features

- › M23 plug connector, 18-pin + PE
 - › Straight plug connector
 - › PUR cable
 - › Cable length 8 m
 - › With flying lead
 - › Cores color-coded
-

- ▼ Connection cable with plug connector M23 with option C1825, 10m, straight



092898 C-M23F19-19XDIFPU10,0-MA-092898

▼ Features

- › M23 plug connector, 18-pin + PE
 - › Straight plug connector
 - › PUR cable
 - › Cable length 10 m
 - › With flying lead
 - › Cores color-coded
-

- ▼ Connection cable with plug connector M23 with option C1825, 15m, straight



077016 C-M23F19-19XDIFPU15,0-MA-077016

▼ Features

- › M23 plug connector, 18-pin + PE
 - › Straight plug connector
 - › PUR cable
 - › Cable length 15 m
 - › With flying lead
 - › Cores color-coded
-

- ▼ Connection cable with plug connector M23 with option C1825, 20m, straight



092726 C-M23F19-19XDIFPU20,0-MA-092726

▼ Features

- › M23 plug connector, 18-pin + PE
 - › Straight plug connector
 - › PUR cable
 - › Cable length 20 m
 - › With flying lead
 - › Cores color-coded
-

- ▼ Connection cable with plug connector M23 with option C1825, 25m, straight



092727 C-M23F19-19XDIFPU25,0-MA-092727

▼ Features

- › M23 plug connector, 18-pin + PE
 - › Straight plug connector
 - › PUR cable
 - › Cable length 25 m
 - › With flying lead
 - › Cores color-coded
-

- ▼ Connection cable with plug connector M23 with option C1825, 30m, straight



095993 C-M23F19-19XDIFPU30,0-MA-095993

▼ Features

- › M23 plug connector, 18-pin + PE
- › Straight plug connector
- › PUR cable
- › Cable length 30 m

- › With flying lead
 - › Cores color-coded
-

- ▼ Connection cable with plug connector M23 with option C1825, 40m, straight



102490 C-M23F19-19XDIFPU40,0-MA-102490

▼ Features

- › M23 plug connector, 18-pin + PE
 - › Straight plug connector
 - › PUR cable
 - › Cable length 40 m
 - › With flying lead
 - › Cores color-coded
-

Miscellaneous accessories

- ▼ Lens set labeled



125359 AY-SET-LNS-SY02-125359



126158 AY-SET-LNS-SY03-126158



120377 AY-SET-LNS-SY01-120377

- ▼ Lens set 5 colors



120344 AY-SET-LNS-0001-120344

- ▼ Lens set 6 colors



120378 AY-SET-LNS-0002-120378

- ▼ Lens set, three colors



158307 AY-SET-LNS-SY04-158307

- ▼ Adhesive labels

114529 MGB-A-PLATESET-NN01-114529

▼ Features

- › Adhesive labels suitable for MGB evaluation modules, bus modules and control modules
- › silver, blank
- › Packaging unit = 10 pcs.

Spare parts

- ▼ Locking module MGB-L1-APA..., (guard locking by spring force) with 3 push buttons, emergency stop, RC18



121368 MGB-L1-APA-AP4A1-S1-R-121368

▼ Features

- › Guard locking with guard locking monitoring
- › Emergency stop according to ISO 13850
- › Three pushbuttons (illuminated)
- › With lens set, six pcs.
- › With plug connector RC18
- › Unicode

-
- ▼ Handle module MGB-H...



100464 MGB-H-AA1A1-R-100464

▼ Features

- › Intelligent bolt tongue
- › Lockout bar
- › Door handle

Function expansion

- ▼ Door knob for MGB-H...



111460 MGB-A-DOORKNOB-S1-111460

▼ Features

- › Aluminum, silver anodized
- › For mounting on all MGB handle modules MGB-H... up to V2.0.0
- › e.g. on sliding doors



124030 MGB-A-DOORKNOB-S2-124030

▼ Features

- › Aluminum, silver anodized
- › For mounting on all MGB handle modules MGB-H... from V3.0.0
- › e.g. on sliding doors

-
- ▼ Door handle for MGB-H...



110277 MGB-A-DOORHANDLE-S1-110277

▼ Features

- › Aluminum silver anodized
- › For mounting on all MGB handle modules MGB-H up to V2.0.0



123926 MGB-A-DOORHANDLE-S2-123926

▼ Features

- › Aluminum silver anodized

- › For mounting on all MGB handle modules MGB-H from V3.0.0

▼ Emergency unlocking for safety system MGB



112989 MGB-A-EMERGENCYRELEASE-112989

▼ Features

- › Quick emergency unlocking
- › sealable

▼ Escape release MGB-E-A...



100465 MGB-E-A-100465

▼ Features

- › Escape release from the danger zone
- › Door handle signal red
- › Extended actuation axis for thicker doors (available optionally)

Mounting accessories

▼ Mounting plate for evaluation modules MGB-L.-AR.-... and MGB-L.-AP.-...



109490 MGB-A-MOUNTINGPLATE-L-109490

▼ Features

- › Easy and quick mounting (only two screws required)
- › Quick module replacement
- › Steel, powder-coated
- › Suitable for doors hinged on the right or left

▼ Mounting plate for all MGB handle modules



109491 MGB-A-MOUNTINGPLATE-H-109491





▼ Features

- › Easy and quick mounting (only two screws required)
- › Quick module replacement
- › Steel, powder-coated
- › Suitable for doors hinged on the right or left

Instructions

























▼ Návod k použití – bezpečnostní systémy MGB-L1...AR.-... / MGB-L2...AR.-... a MGB-L1...AP.-... / MGB-L2...AP.-... od V3.0.0

	Doc. no.	Version	Language	Download
Betriebsanleitung MGB-L1...AR.-... / MGB-L2...AR.-... und MGB-L1...AP.-... / MGB-L2...AP.-... ab V3.0.0	2119167	04-05/18		3.7 MB

Mode d'emploi MGB-L1...AR-... / MGB-L2...AR-... et MGB-L1...AP-... / MGB-L2...AP-... à partir de V3.0.0	2119167	04-05/18		 3.7 MB
Manual de instrucciones MGB-L1...AR-... / MGB- L2...AR-... y MGB-L1...AP-... / MGB-L2...AP-... V3.0.0 o superior	2119167	04-05/18		 3.7 MB
Návod k použití – bezpečnostní systémy MGB- L1...AR-... / MGB-L2...AR-... a MGB-L1...AP-... / MGB-L2...AP-... od V3.0.0	2119167	04-05/18		 4.0 MB
Operating Instructions MGB-L1...AR-... / MGB- L2...AR-... and MGB-L1...AP-... / MGB-L2...AP-... from V3.0.0	2119167	04-05/18		 3.7 MB
Istruzioni di impiego MGB-L1...AR-... / MGB- L2...AR-... und MGB-L1...AP-... / MGB-L2...AP-... da V3.0.0	2119167	04-05/18		 3.7 MB
Handleiding MGB-L1...AR-... / MGB-L2...AR-... en MGB-L1...AP-... / MGB-L2...AP-... vanaf V3.0.0	2119167	04-05/18		 3.7 MB
Instrukcja obsługi MGB-L1...AR-... / MGB-L2...AR- ... i MGB-L1...AP-... / MGB-L2...AP-... od V3.0.0	2119167	04-05/18		 4.0 MB
Manual de instruções MGB-L1...AR-... / MGB- L2...AR-... e MGB-L1...AP-... / MGB-L2...AP-... a partir de V3.0.0	2119167	04-05/18		 3.7 MB
Инструкция по эксплуатации MGB-L1...AR-... / MGB-L2...AR-... и MGB-L1...AP-... / MGB-L2...AP- ... с V3.0.0	2119167	04-05/18		 4.2 MB
Návod na prevádzku Bezpečnostné systémy MGB-L1...AR-... / MGB-L2...AR-... a MGB-L1...AP- ... / MGB-L2...AP-... od V3.0.0	2119167	04-05/18		 4.0 MB
Instruktionsbok MGB-L1...AR-... / MGB-L2...AR-... och MGB-L1...AP-... / MGB-L2...AP-... fr. V3.0.0	2119167	04-05/18		 3.7 MB
İşletim kılavuzu MGB-L1...AR-... / MGB-L2...AR-... ve MGB-L1...AP-... / MGB-L2...AP-... itibaren V3.0.0	2119167	04-05/18		 4.1 MB
操作指示書 安全システム MGB-L1...-AR-... / MGB- L2...-AR-... および MGB-L1...-AP-... / MGB-L2...- AP-... V3.0.0以降	2119167	04-05/18		 4.1 MB
使用说明书 安全系统 MGB-L1...-AR-... / MGB-L2...- AR-...和MGB-L1...-AP-... / MGB-L2...-AP-... V3.0.0 以上	2119167	04-05/18		 4.1 MB







 Sicherheitsinformation (Teil der Betriebsanleitung Sicherheitssystem MGB-AR/MGB-AP) ab
V3.0.0

Doc. no. **Version** **Language** **Download**

Sicherheitsinformation (Teil der Betriebsanleitung Sicherheitssystem MGB-AR/MGB-AP) ab V3.0.0 Información de seguridad (parte del manual de instrucciones Sistema de seguridad MGB-AR/MGB-AP) V3.0.0 o superior Information de sécurité (partie du mode d'emploi Système de sécurité MGB-AR/MGB-AP) à partir de V3.0.0 Informazioni sulla sicurezza (Parte delle istruzioni di impiego Sistema di sicurezza MGB-AR/MGB-AP) da V3.0.0 Säkerhetsinformation (Del av instruktionsboken Säkerhetssystem MGB-AR/MGB-AP) från V3.0.0 Safety Information (Part of the Operating Instructions Safety System MGB-AR/MGB-AP) from V3.0.0	123151	01-02/15	     	 0.6 MB
Veiligheidsinformatie (Deel van de handleiding Beveiligingssysteem MGB-AR/MGB-AP) vanaf V3.0.0	123151	01-02/15		 0.2 MB
Informação de segurança (Parte do manual de instruções Sistema de segurança MGB-AR/MGB-AP) a partir de V3.0.0	123151	01-02/15		 0.2 MB
Bezpečnostní informace (součást návodu k použití „Bezpečnostní systém MGB-AR/MGB-AP“) od V3.0.0	123151	01-02/15		 0.2 MB
Informacje o bezpieczeństwie (Część instrukcji obsługi System bezpieczeństwa MGB-AR/MGB-AP) od V3.0.0	123151	01-02/15		 0.2 MB
Информация о безопасности (часть инструкции по эксплуатации Предохранительная система MGB-AR/MGB-AP) с V3.0.0	123151	01-02/15		 0.3 MB
Bezpečnostná informácia (časť návodu na prevádzku Bezpečnostný systém MGB-AR/MGB-AP) od V3.0.0	123151	01-02/15		 0.2 MB
Güvenlik bilgisi (İşletim kılavuzunun parçası emniyet sistemi MGB-AR/MGB-AP) V3.0.0 ve üstü	123151	01-02/15		 0.3 MB
安全信息 (安全系统 MGB-AR/MGB-AP使用说明书的组成部分) V3.0.0以上	123151	01-02/15		 0.3 MB
安全情報 MGB-AR/MGB-AP	123151	01-02/15		 0.6 MB

Declaration of conformity

EU-Konformitätserklärung

	Doc. no.	Version	Language	Download
EU-Konformitätserklärung Declaración UE de conformidad Déclaration UE de conformité Dichiarazione di conformità EU declaration of conformity	2123150	08-01/17	    	 0.3 MB