

ITEM 156001 MGB-L1-APA-AD3A1-S9-L-156001

Description	Technical data	Accessories	Downloads
-------------	----------------	-------------	-----------

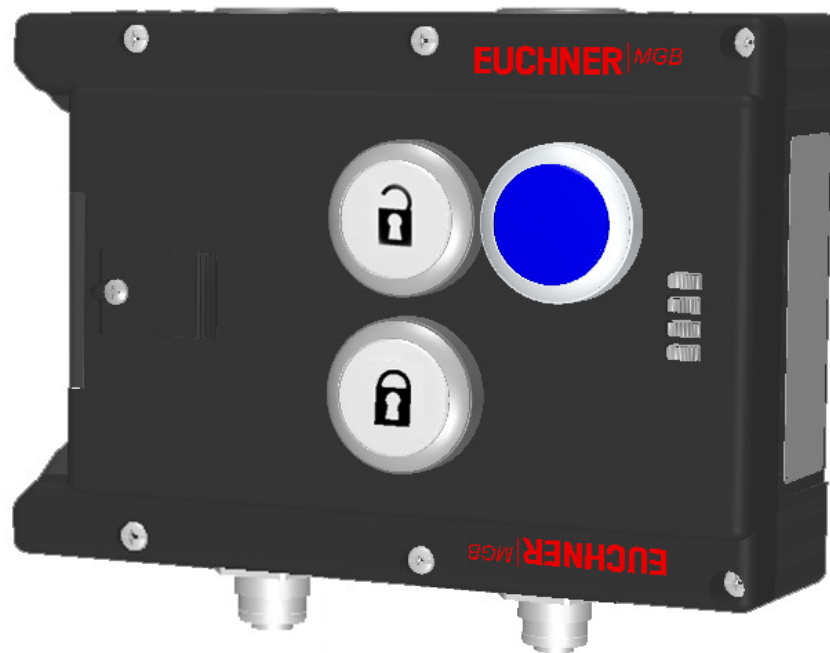

Features

- › Guard locking with guard locking monitoring
- › Three pushbuttons (illuminated, bu, wh, wh)
- › With plug connector M12, 5-pin
- › With plug connector M12, 8-pin
- › Unicode
- › Connection for Bihl-Wiedemann modules BW 3376 and BW 3377

Guard locking type

MGB- The locking arm is held in the locked position by spring force and is **L1...** unlocked by solenoid force (closed-circuit current principle, mechanically locked).

Door stop

A mechanical door stop is permanently integrated into the evaluation module of the MGB. A marking on the stop makes adjustment easier.

LED indicator

The LED indicator indicates all important system and status information.

Monitoring outputs

- OT** Bolt tongue inserted in the evaluation module
- OI** Diagnostics; there is a fault

Pushbutton

- S1** One NO contact, blue, illuminated
- S2** One NO contact, white, illuminated
- S3** One NO contact, white, illuminated

Approvals



Mechanical values and environment

Housing material	Reinforced plastic; die-cast zinc nickel-plated, stainless steel
Weight	Net 0,75 kg
Ambient temperature	At $U_B = 24V$ DC -20 ... 55 °C
Degree of protection	IP65
Mechanical life	1×10^6
In case of use as door stop, and 1 Joule impact energy	$0,1 \times 10^6$
Installation position	Door hinge DIN left
Switching frequency	0,25 Hz
Connection	Plug connector SM5 [1] Plug connector SM8 [2]
Guard locking principle	Closed-circuit current principle
Locking force F_{Zh}	2000 N

Electrical connection ratings

Utilization category according to EN 60947-5-2	DC-13 24V 200mA [3]
Rated insulation voltage U_i	30 V
Rated impulse withstand voltage U_{imp}	1,5 kV

Degree of contamination (external, according to EN 60947-1)	3
Safety class	III
Discrepancy time	
Between FO1A and FO1B	max.10 ms
Risk time according to EN 60947-5-3	max.350 ms
Transponder coding	Unicode
	Power supply U_B
Operating voltage DC	
	U _B 24 V DC -15% ... 10% [4]
Current consumption	
	I _{UB} max.80 mA [5]
	Power supply U_A
Operating voltage DC	
	U _A 24 V DC -15% ... 10% [6]
Current consumption	
	I _{UA} max.375 mA [7]
	Safety outputs FO1A, FO1B
Test pulses	max.0,3 ms
Test-pulse interval	min.100 ms
Type of output	Semiconductor outputs, p-switching, short circuit-proof
Output voltage	
U _{FO1A} /U _{FO1B} HIGH	U _B -2V ... U _B V DC [8]
U _{FO1A} /U _{FO1B} LOW	0 ... 1 V DC
Output current	
Per safety output FO1A / FO1B	1 ... 200 mA
	Monitoring outputs OD, OT, OL, OI
Type of output	Semiconductor outputs, p-switching, short circuit-proof
Output voltage	U _A -2V ... U _A V DC [9]
Output current	max.50 mA
	Controls and indicators
Switching voltage	U _A V
Switching current	1 ... 10 mA
Breaking capacity	max.0,25 W
Power supply LED	24 V DC
	Solenoid control input IMP1, IMP2, IMM
Test pulses	max.5 ms
Test-pulse interval	min.100 ms

Controls and indicators

Assignment diagram	L1
Control/indicator	
	Position 1
Version	Illuminated push buttons

Special features	
Color	Blue
Switching element	1NO
Control/indicator	
	Position 2
Version	Illuminated push buttons
Special features	Printed
Color	white
Switching element	1NO
Control/indicator	
	Position 3
Version	Illuminated push buttons
Special features	Printed
Color	white
Switching element	1NO

Miscellaneous

Product version number	V3.0.3
------------------------	--------

Reliability values acc. to EN ISO 13849-1

	Monitoring of guard locking and the safety guard position
Category	4
Performance Level	PL e
PFH _D	3.7×10^{-9}
	Control of the guard locking
Category	4
Performance Level	PL e
PFH _D	2.8×10^{-9}

Mission time	20 y
--------------	------

[1] X6

[2] X7

[3] Caution: outputs must be protected with a free-wheeling diode in case of inductive loads.

[4, 6] (Reverse polarity protected, regulated, residual ripple <5%, PELV)

[5] (no load on outputs)

[7] (With energized guard locking solenoid and unloaded outputs OD, OT, OL, OI, +20 °C, 24V)

[8, 9] Value at a switching current of 50mA without taking into account the cable lengths

Dimension drawing

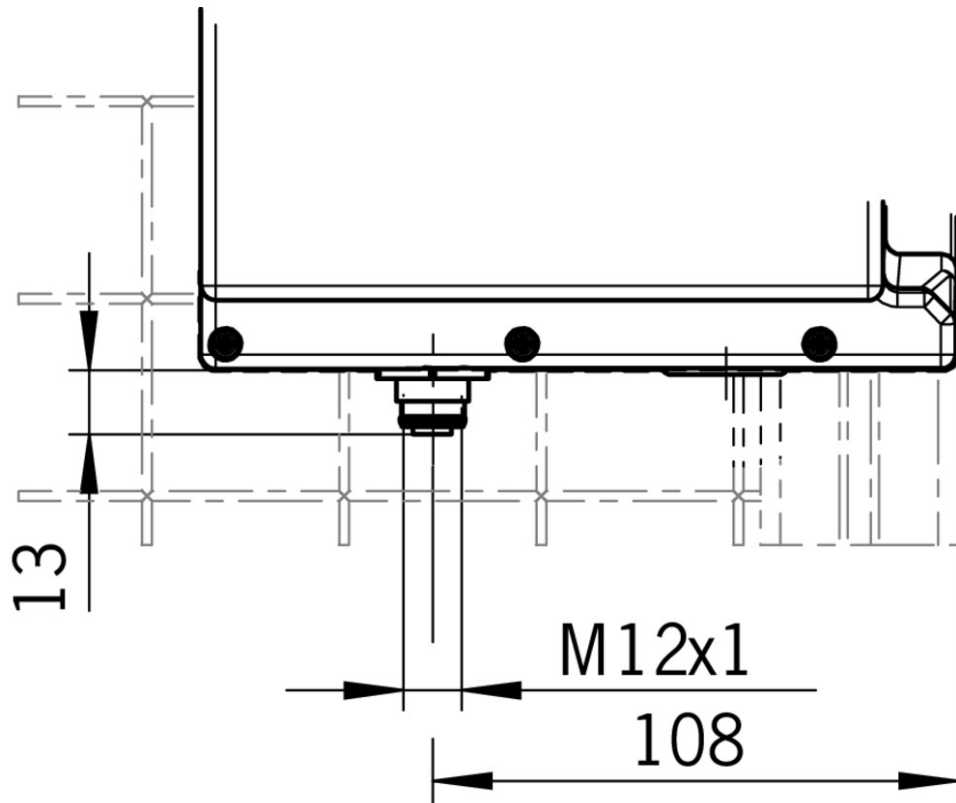

①

②



Dimension drawing

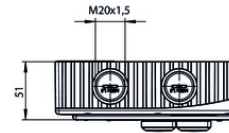
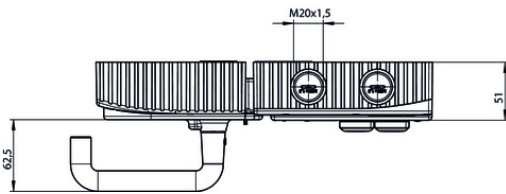
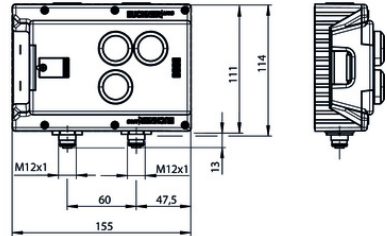
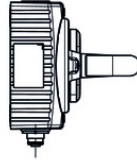
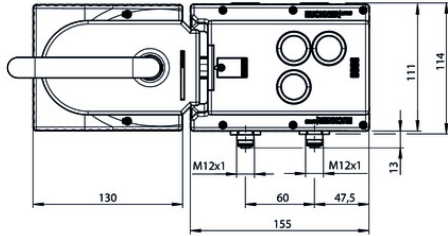
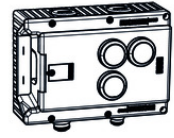
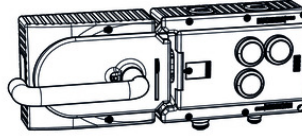
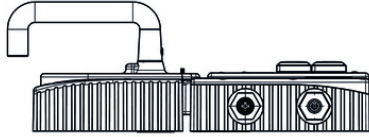

Dimension drawing

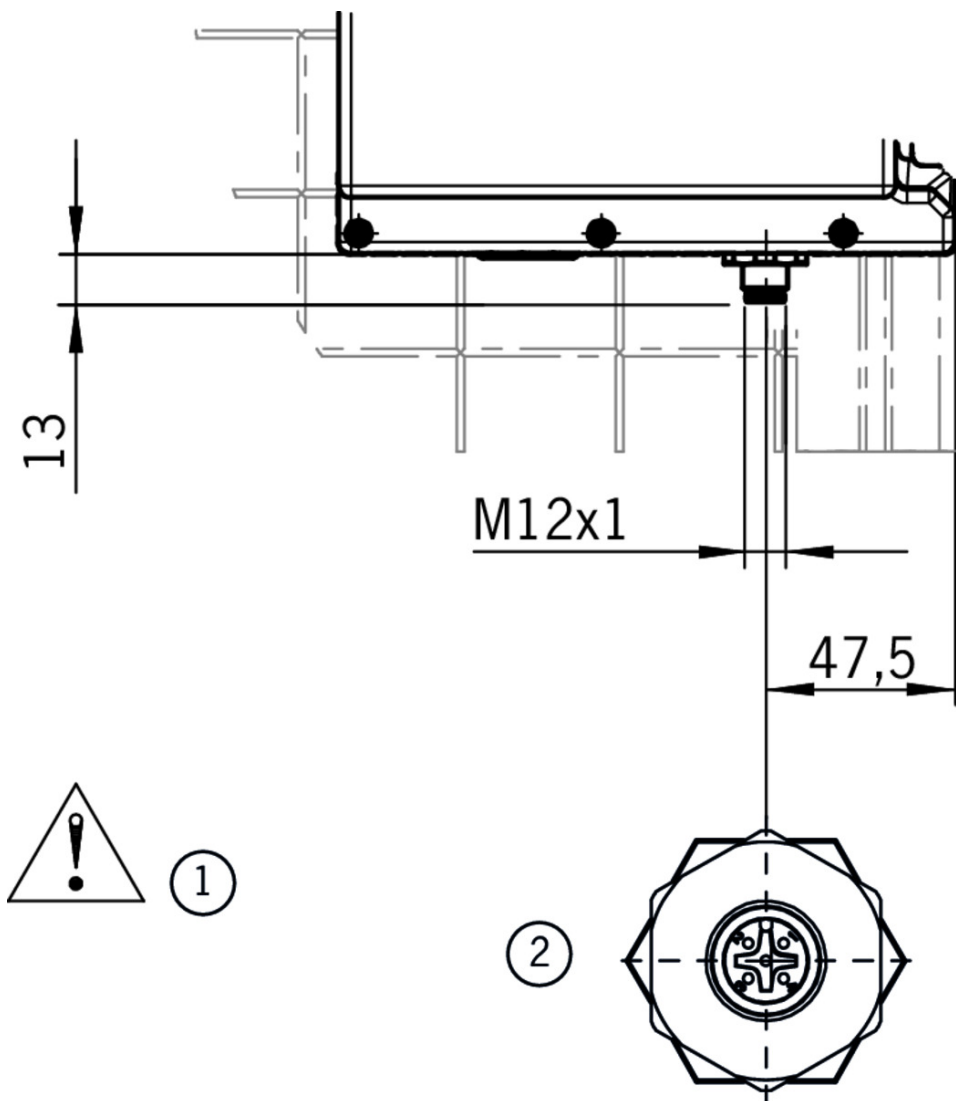

Legende

- 1 Plug connector current rating: max. 1.5 A
- 2 Built-in connector not aligned

Plug connector M12

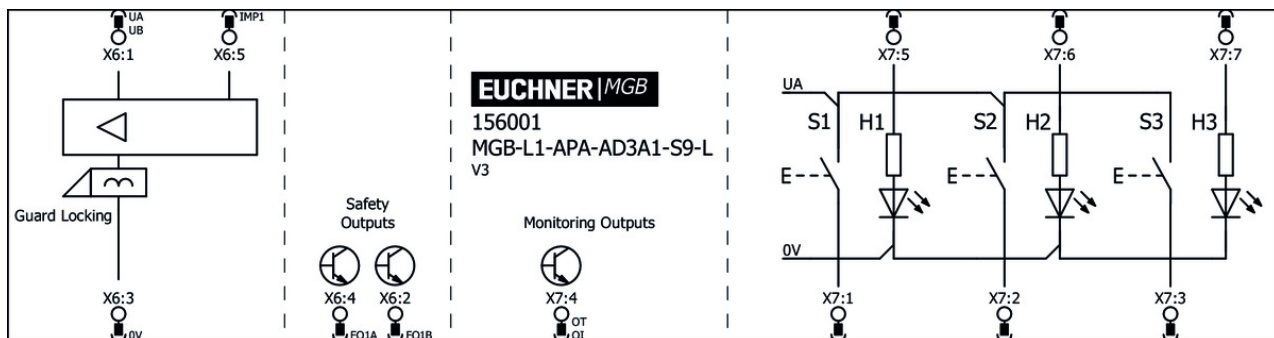

Miscellaneous accessories

✓ Lens set 5 colors



120344 AY-SET-LNS-0001-120344

✓ Lens set 6 colors



120378 AY-SET-LNS-0002-120378

✓ Lens set labeled



120377 AY-SET-LNS-SY01-120377



126158 AY-SET-LNS-SY03-126158



125359 AY-SET-LNS-SY02-125359

✓ Lens set, three colors



158307 AY-SET-LNS-SY04-158307

Mounting accessories

✓ Mounting plate for evaluation modules MGB-L.-AR.-... and MGB-L.-AP.-...



109490 MGB-A-MOUNTINGPLATE-L-109490

✓ Features

- › Easy and quick mounting (only two screws required)
 - › Quick module replacement
 - › Steel, powder-coated
 - › Suitable for doors hinged on the right or left
-

Function expansion

✓ Emergency unlocking for safety system MGB



112989 MGB-A-EMERGENCYRELEASE-112989

✓ Features

- › Quick emergency unlocking
 - › sealable
-

Connection material

- ▼ Connection cable with plug connector M12, 5-pin, 50m



156064 C-M12F05-05X034PV50,0-MA-156064

- ▼ Features

- › M12 female plug, 5-pin
 - › Straight plug connector
 - › PVC cable
 - › Cable length 50 m
 - › With flying lead
-

- ▼ Connection cable with plug connector M12, 5-pin, 20m



100185 C-M12F05-05X034PV20,0-MA-100185

- ▼ Features

- › M12 female plug, 5-pin
 - › Straight plug connector
 - › PVC cable
 - › Cable length 20 m
 - › With flying lead
-

- ▼ Connection cable with plug connector M12, 5-pin, 10m



100184 C-M12F05-05X034PV10,0-MA-100184

- ▼ Features

- › M12 female plug, 5-pin
 - › Straight plug connector
 - › PVC cable
 - › Cable length 10 m
 - › With flying lead
-

- ▼ Connection cable with straight plug connector M12, 5-pin, 5m



100183 C-M12F05-05X034PV05,0-MA-100183

- ▼ Features

- › M12 female plug, 5-pin
 - › Straight plug connector
 - › PVC cable
 - › Cable length 5 m
 - › With flying lead
-



113620 C-M12F05-05X034PU05,0-MA-113620

- ▼ Features

- › M12 female plug, 5-pin
 - › Straight plug connector
 - › PUR cable
 - › Cable length 5 m
 - › With flying lead
-

- ▼ Connection cable with 2 plug connectors M12, 5-pin, 20m



100182 C-M12F05-05X034PV20,0-M12M05-100182

▼ Features

- › M12 female plug to M12 plug connector, 5-pin
 - › Straight female plug and plug connector
 - › PVC cable
 - › Cable length 20 m
-



119971 C-M12F05-05X034PU20,0-M12M05-119971

▼ Features

- › M12 female plug to M12 plug connector, 5-pin
 - › Straight female plug and plug connector
 - › PUR cable
 - › Cable length 20 m
-

▼ Connection cable with 2 plug connectors M12, 5-pin, 10m



100181 C-M12F05-05X034PV10,0-M12M05-100181

▼ Features

- › M12 female plug to M12 plug connector, 5-pin
 - › Straight female plug and plug connector
 - › PVC cable
 - › Cable length 10 m
-



119947 C-M12F05-05X034PU10,0-M12M05-119947

▼ Features

- › M12 female plug to M12 plug connector, 5-pin
 - › Straight female plug and plug connector
 - › PUR cable
 - › Cable length 10 m
-

▼ Connection cable with 2 plug connectors M12, 5-pin, 5m



100180 C-M12F05-05X034PV05,0-M12M05-100180

▼ Features

- › M12 female plug to M12 plug connector, 5-pin
 - › Straight female plug and plug connector
 - › PVC cable
 - › Cable length 5 m
-



119932 C-M12F05-05X034PU05,0-M12M05-119932

▼ Features

- › M12 female plug to M12 plug connector, 5-pin
 - › Straight female plug and plug connector
 - › PUR cable
 - › Cable length 5 m
-

▼ Connection cable with straight plug connector M12, 5-pin, 30 m



122784 C-M12F05-05X034PU30,0-MA-122784

▼ Features

- › M12 female plug, 5-pin

- › Straight plug connector
 - › PUR cable
 - › Cable length 30 m
 - › With flying lead
-

▼ Connection cable with straight plug connector M12, 5-pin, 20 m



113682 C-M12F05-05X034PU20,0-MA-113682

▼ Features

- › M12 female plug, 5-pin
 - › Straight plug connector
 - › PUR cable
 - › Cable length 20 m
 - › With flying lead
-

▼ Connection cable with straight plug connector M12, 5-pin, 10m



113640 C-M12F05-05X034PU10,0-MA-113640

▼ Features

- › M12 female plug, 5-pin
 - › Straight plug connector
 - › PUR cable
 - › Cable length 10 m
 - › With flying lead
-

▼ Connecting cable with plug connector M12, 8-pin, 40 m



156065 C-M12F08-08X025PV40,0-MA-156065

▼ Features

- › M12 female plug, 8-pin
 - › Straight plug connector
 - › PVC cable
 - › Cable length 40 m
 - › With flying lead
-

▼ Connection cable with plug connector M12, 8-pin, 30m



115116 C-M12F08-08X025PV30,0-MA-115116

▼ Features

- › M12 female plug, 8-pin
 - › Straight plug connector
 - › PVC cable
 - › Cable length 30 m
 - › With flying lead
-



115257 C-M12F08-08X025PU30,0-MA-115257

▼ Features

- › M12 female plug, 8-pin
- › Straight plug connector
- › PUR cable
- › Cable length 30 m
- › With flying lead

▼ Connection cable with plug connector M12, 8-pin, 20m



100179 C-M12F08-08X025PV20,0-MA-100179

▼ Features

- › M12 female plug, 8-pin
- › Straight plug connector
- › PVC cable
- › Cable length 20 m
- › With flying lead



115114 C-M12F08-08X025PU20,0-MA-115114

▼ Features

- › M12 female plug, 8-pin
- › Straight plug connector
- › PUR cable
- › Cable length 20 m
- › With flying lead

▼ Connection cable with plug connector M12, 8-pin, 10m



100178 C-M12F08-08X025PV10,0-MA-100178

▼ Features

- › M12 female plug, 8-pin
- › Straight plug connector
- › PVC cable
- › Cable length 10 m
- › With flying lead



115113 C-M12F08-08X025PU10,0-MA-115113

▼ Features

- › M12 female plug, 8-pin
- › Straight plug connector
- › PUR cable
- › Cable length 10 m
- › With flying lead

▼ Connection cable with plug connector M12, 8-pin, 5m



100177 C-M12F08-08X025PV05,0-MA-100177

▼ Features

- › M12 female plug, 8-pin
- › Straight plug connector
- › PVC cable
- › Cable length 5 m
- › With flying lead



115112 C-M12F08-08X025PU05,0-MA-115112





























▼ Features

- › M12 female plug, 8-pin
- › Straight plug connector
- › PUR cable

- › Cable length 5 m
- › With flying lead

Instructions

✓ Návod k použití – bezpečnostní systémy MGB-L1...AR.-... / MGB-L2...AR.-... a MGB-L1...AP.-... / MGB-L2...AP.-... od V3.0.0

	Doc. no.	Version	Language	Download
Betriebsanleitung MGB-L1...AR.-... / MGB-L2...AR.-... und MGB-L1...AP.-... / MGB-L2...AP.-... ab V3.0.0	2119167	04-05/18		 3.7 MB
Mode d'emploi MGB-L1...AR.-... / MGB-L2...AR.-... et MGB-L1...AP.-... / MGB-L2...AP.-... à partir de V3.0.0	2119167	04-05/18		 3.7 MB
Manual de instrucciones MGB-L1...AR.-... / MGB-L2...AR.-... y MGB-L1...AP.-... / MGB-L2...AP.-... V3.0.0 o superior	2119167	04-05/18		 3.7 MB
Návod k použití – bezpečnostní systémy MGB-L1...AR.-... / MGB-L2...AR.-... a MGB-L1...AP.-... / MGB-L2...AP.-... od V3.0.0	2119167	04-05/18		 4.0 MB
Operating Instructions MGB-L1...AR.-... / MGB-L2...AR.-... and MGB-L1...AP.-... / MGB-L2...AP.-... from V3.0.0	2119167	04-05/18		 3.7 MB
Istruzioni di impiego MGB-L1...AR.-... / MGB-L2...AR.-... und MGB-L1...AP.-... / MGB-L2...AP.-... da V3.0.0	2119167	04-05/18		 3.7 MB
Handleiding MGB-L1...AR.-... / MGB-L2...AR.-... en MGB-L1...AP.-... / MGB-L2...AP.-... vanaf V3.0.0	2119167	04-05/18		 3.7 MB
Instrukcja obsługi MGB-L1...AR.-... / MGB-L2...AR.-... i MGB-L1...AP.-... / MGB-L2...AP.-... od V3.0.0	2119167	04-05/18		 4.0 MB
Manual de instruções MGB-L1...AR.-... / MGB-L2...AR.-... e MGB-L1...AP.-... / MGB-L2...AP.-... a partir de V3.0.0	2119167	04-05/18		 3.7 MB
Инструкция по эксплуатации MGB-L1...AR.-... / MGB-L2...AR.-... и MGB-L1...AP.-... / MGB-L2...AP.-... с V3.0.0	2119167	04-05/18		 4.2 MB
Návod na prevádzku Bezpečnostné systémy MGB-L1...AR.-... / MGB-L2...AR.-... a MGB-L1...AP.-... / MGB-L2...AP.-... od V3.0.0	2119167	04-05/18		 4.0 MB
Instruktionsbok MGB-L1...AR.-... / MGB-L2...AR.-... och MGB-L1...AP.-... / MGB-L2...AP.-... fr. V3.0.0	2119167	04-05/18		 3.7 MB
İşletim kılavuzu MGB-L1...AR.-... / MGB-L2...AR.-... ve MGB-L1...AP.-... / MGB-L2...AP.-... itibaren V3.0.0	2119167	04-05/18		 4.1 MB
操作指示書 安全システム MGB-L1...AR.-... / MGB-L2...AR.-... および MGB-L1...AP.-... / MGB-L2...AP.-... V3.0.0以降	2119167	04-05/18		 4.1 MB

使用说明书 安全系统 MGB-L1...-AR... / MGB-L2...-AR...和MGB-L1...-AP... / MGB-L2...-AP... V3.0.0 以上

2119167

04-05/18



4.1 MB





Sicherheitsinformation (Teil der Betriebsanleitung Sicherheitssystem MGB-AR/MGB-AP) ab V3.0.0

	Doc. no.	Version	Language	Download
Sicherheitsinformation (Teil der Betriebsanleitung Sicherheitssystem MGB-AR/MGB-AP) ab V3.0.0 Información de seguridad (parte del manual de instrucciones Sistema de seguridad MGB-AR/MGB-AP) V3.0.0 o superior Information de sécurité (partie du mode d'emploi Système de sécurité MGB-AR/MGB-AP) à partir de V3.0.0 Informazioni sulla sicurezza (Parte delle istruzioni di impiego Sistema di sicurezza MGB-AR/MGB-AP) da V3.0.0 Säkerhetsinformation (Del av instruktionsboken Säkerhetssystem MGB-AR/MGB-AP) från V3.0.0 Safety Information (Part of the Operating Instructions Safety System MGB-AR/MGB-AP) from V3.0.0	123151	01-02/15		0.6 MB
Veiligheidsinformatie (Deel van de handleiding Beveiligingssysteem MGB-AR/MGB-AP) vanaf V3.0.0	123151	01-02/15		0.2 MB
Informação de segurança (Parte do manual de instruções Sistema de segurança MGB-AR/MGB-AP) a partir de V3.0.0	123151	01-02/15		0.2 MB
Bezpečnostní informace (součást návodu k použití „Bezpečnostní systém MGB-AR/MGB-AP“) od V3.0.0	123151	01-02/15		0.2 MB
Informacje o bezpieczeństwie (Część instrukcji obsługi System bezpieczeństwa MGB-AR/MGB-AP) od V3.0.0	123151	01-02/15		0.2 MB
Информация о безопасности (часть инструкции по эксплуатации Предохранительная система MGB-AR/MGB-AP) с V3.0.0	123151	01-02/15		0.3 MB
Bezpečnostná informácia (časť návodu na prevádzku Bezpečnostný systém MGB-AR/MGB-AP) od V3.0.0	123151	01-02/15		0.2 MB
Güvenlik bilgisi (İşletim kılavuzunun parçası emniyet sistemi MGB-AR/MGB-AP) V3.0.0 ve üstü	123151	01-02/15		0.3 MB
安全信息 (安全系统 MGB-AR/MGB-AP使用说明书的组成部分) V3.0.0以上	123151	01-02/15		0.3 MB
安全情報 MGB-AR/MGB-AP	123151	01-02/15		0.6 MB

Declaration of conformity

EU-Konformitätserklärung

Doc. no. Version Language Download

EU-Konformitätserklärung	2123150	08-01/17		 0.3 MB
Declaración UE de conformidad				
Déclaration UE de conformité				
Dichiarazione di conformità				
EU declaration of conformity			