

ITEM 156002 MGB-L1HE-APA-R-156002

Description	Technical data	Accessories	Downloads
-------------	----------------	-------------	-----------

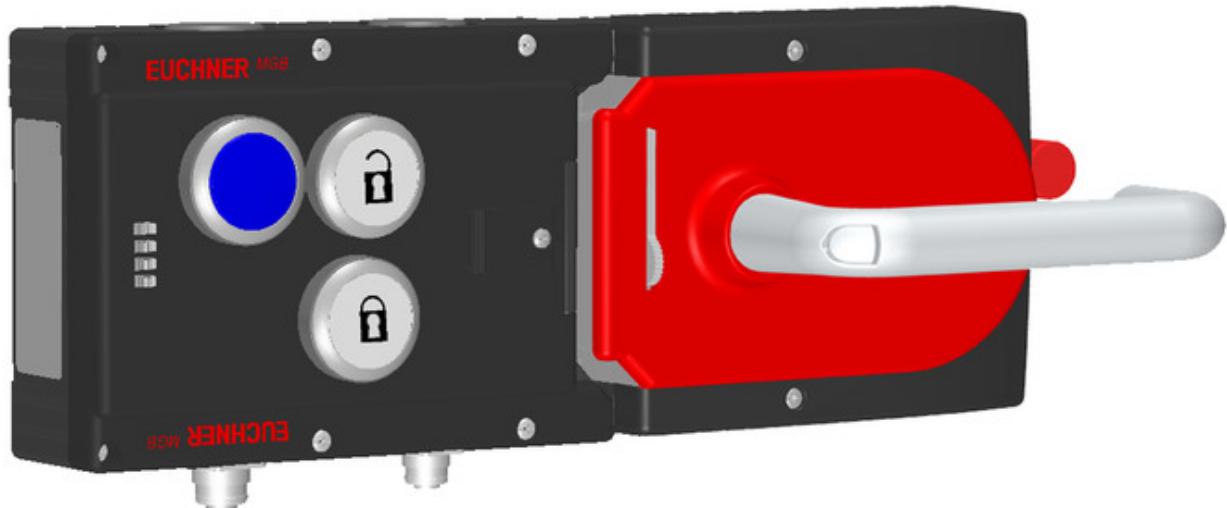

Features

- › Guard locking with guard locking monitoring
- › Three pushbuttons (illuminated, bu wh, wh)
- › With plug connector M12, 5-pin
- › With plug connector M12, 8-pin
- › Unicode
- › Connection for Bihl-Wiedemann modules BW 3376 and BW 3377

Guard locking type

MGB- The locking arm is held in the locked position by spring force and is
L1... unlocked by solenoid force (closed-circuit current principle, mechanically locked).

Door stop

A mechanical door stop is permanently integrated into the evaluation module of the MGB. A marking on the stop makes adjustment easier.

LED indicator

The LED indicator indicates all important system and status information.

Monitoring outputs

- OT** Bolt tongue inserted in the evaluation module
 - OI** Diagnostics; there is a fault
-

Pushbutton

- S1** One NO contact, illuminated
 - S2** One NO contact, illuminated
 - S3** One NO contact, illuminated
-

Escape release

The escape release enables people shut in to open the guard locked door from the danger zone.

Components included in the set



155999 Locking module MGB-L1-APA-AD3A1-S9-R-155999
✓ Features



100464 Handle module MGB-H-AA1A1-R-100464
✓ Features



100465 Escape release MGB-E-A-100465
✓ Features

Dimension drawing

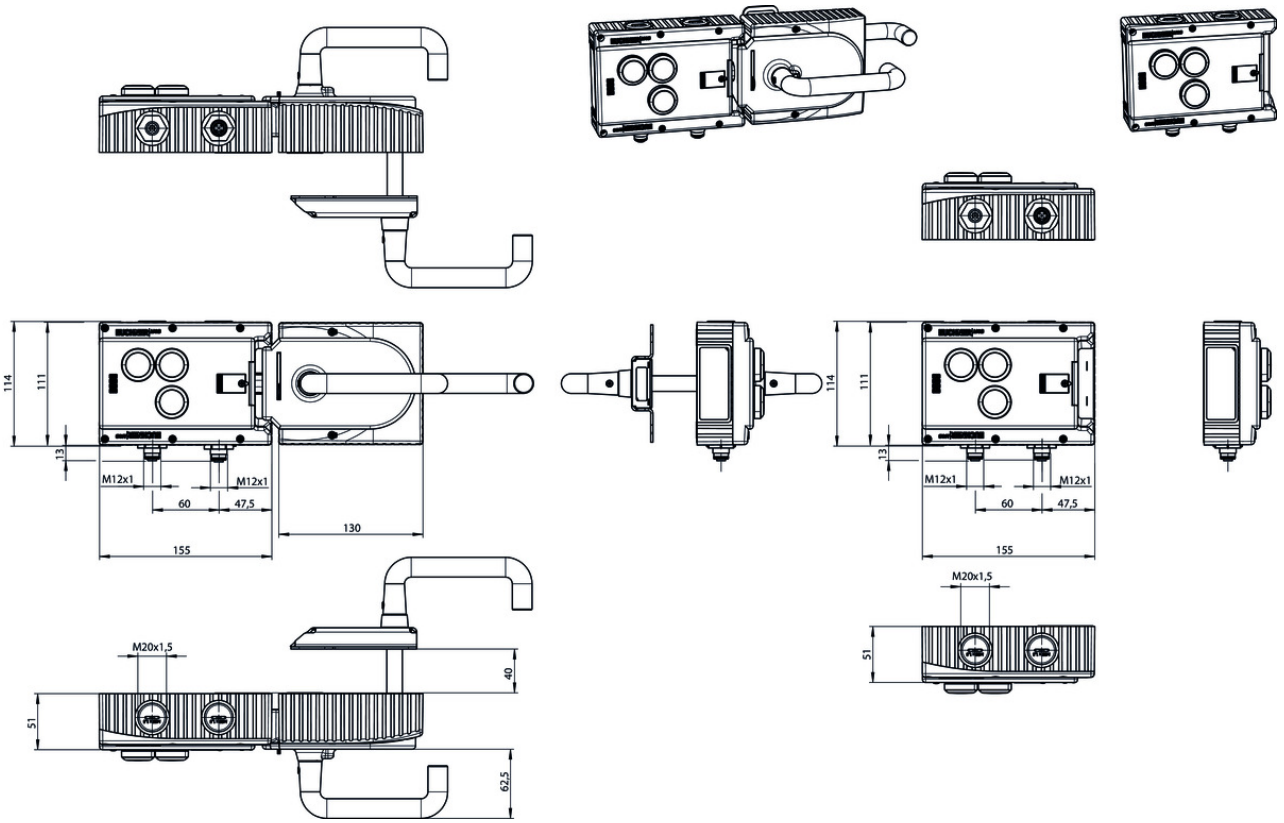

Dimension drawing

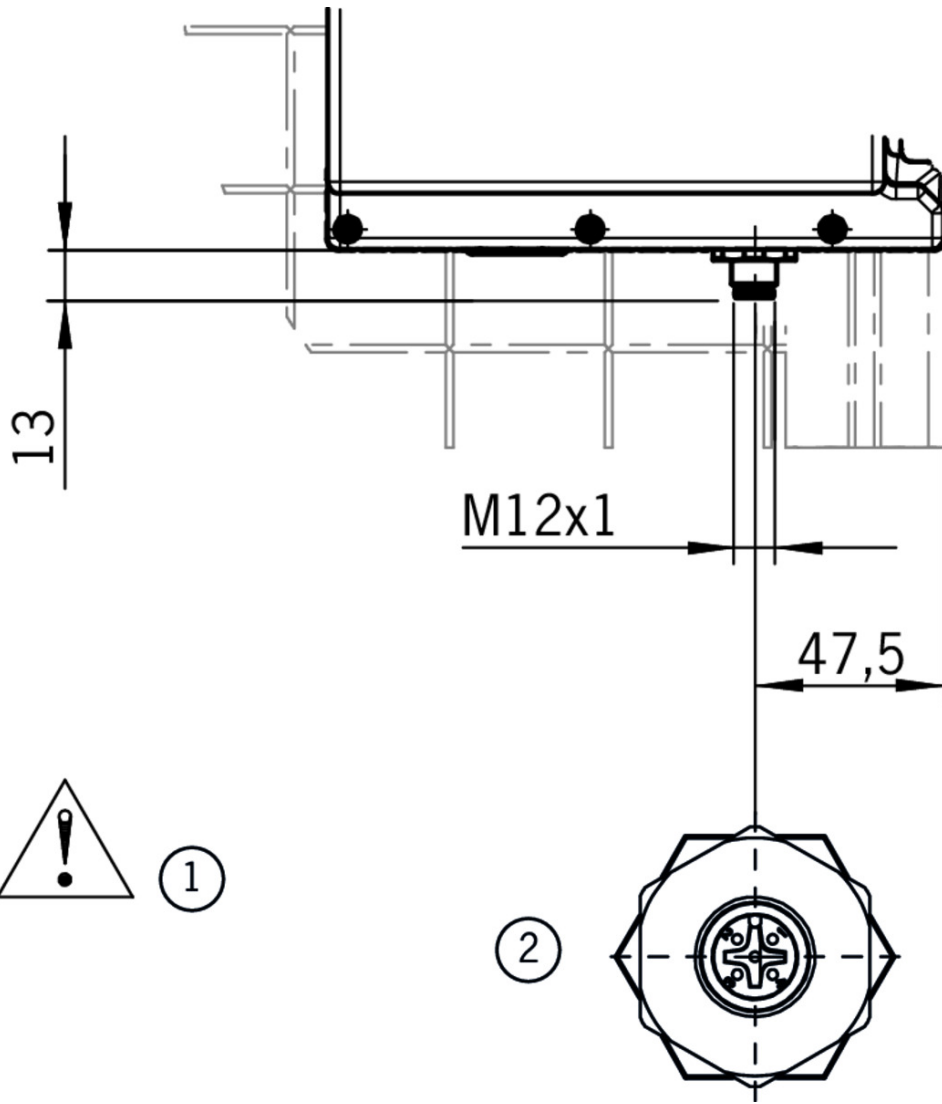

Dimension drawing

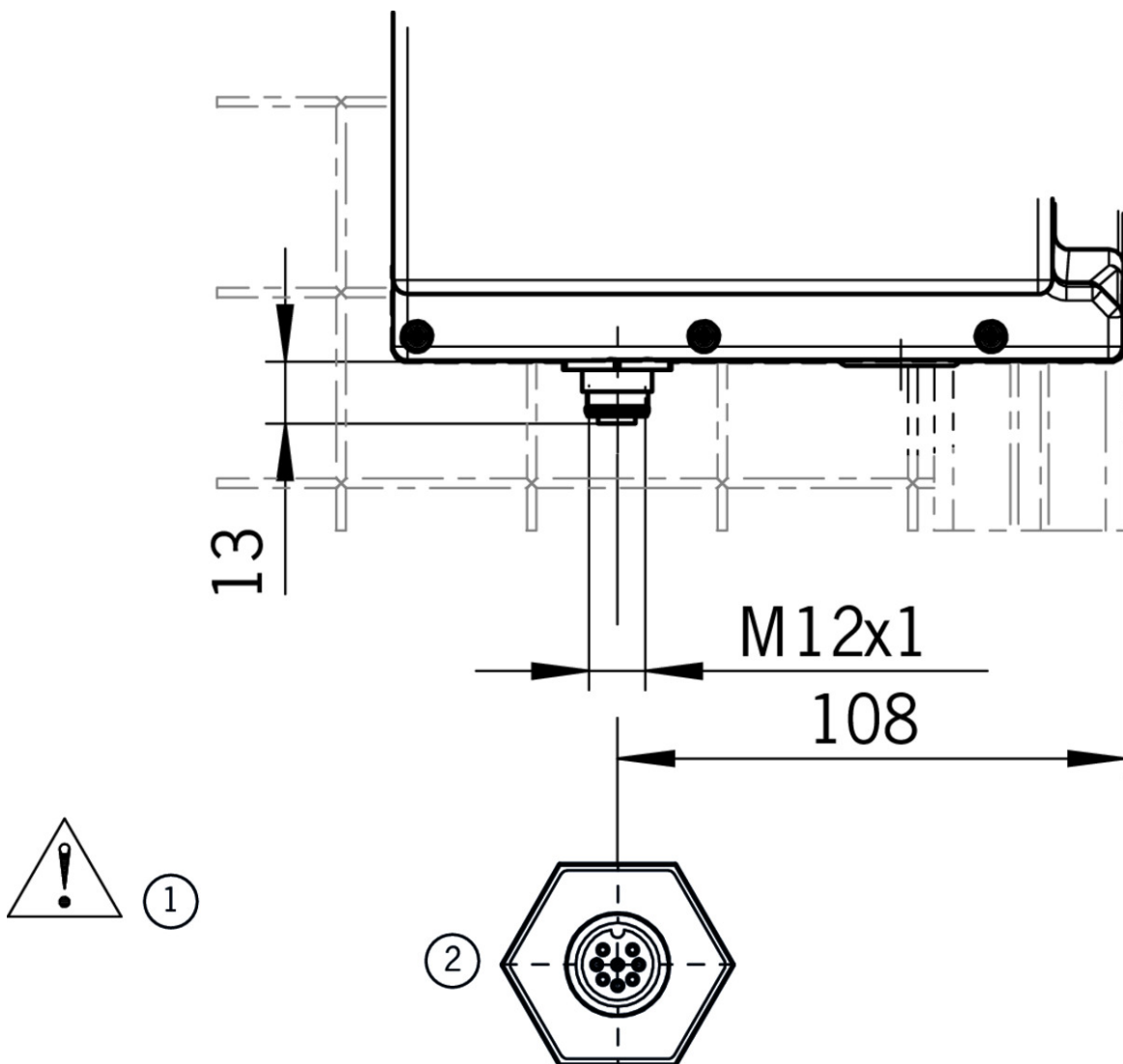

Legende

- 1 Plug connector current rating: max. 1.5 A
- 2 Built-in connector not aligned

Plug connector M12

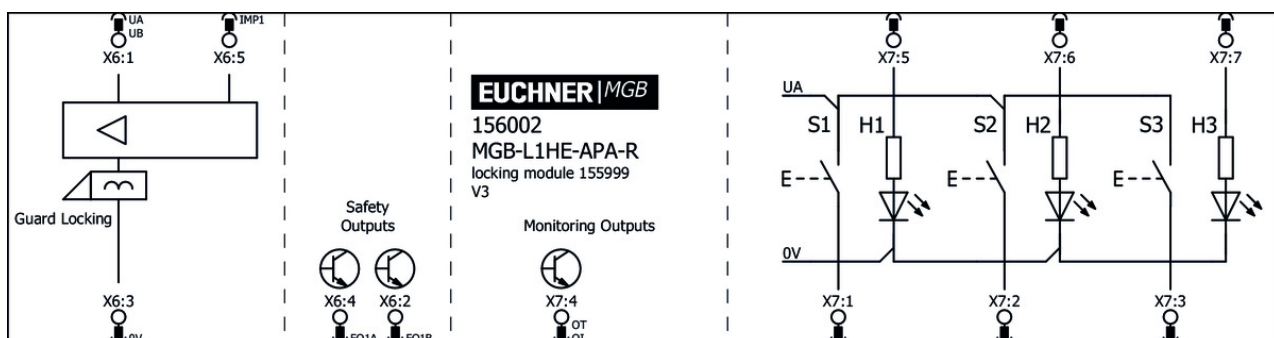

Spare parts

- ✓ Locking module MGB-L1-APA... (guard locking by spring force) with three pushbuttons, including label carrier, M12 for enabling switch, M12



155999 MGB-L1-APA-AD3A1-S9-R-155999

- ✓ Features

- › Guard locking with guard locking monitoring
 - › Three pushbuttons (illuminated, bu, wh, wh)
 - › With plug connector M12, 5-pin
 - › With plug connector M12, 8-pin
 - › Unicode
 - › Connection for Bihl-Wiedemann modules BW 3376 and BW 3377
-

- ✓ Handle module MGB-H...



100464 MGB-H-AA1A1-R-100464

- ✓ Features

- › Intelligent bolt tongue
 - › Lockout bar
 - › Door handle
-

Function expansion

- ✓ Escape release MGB-E-A...



100465 MGB-E-A-100465

- ✓ Features

- › Escape release from the danger zone
 - › Door handle signal red
 - › Extended actuation axis for thicker doors (available optionally)
-

- ✓ Door knob for MGB-H...



111460 MGB-A-DOORKNOB-S1-111460

- ✓ Features

- › Aluminum, silver anodized
 - › For mounting on all MGB handle modules MGB-H... up to V2.0.0
 - › e.g. on sliding doors
-



124030 MGB-A-DOORKNOB-S2-124030

- ✓ Features

- › Aluminum, silver anodized
 - › For mounting on all MGB handle modules MGB-H... from V3.0.0
 - › e.g. on sliding doors
-

- ✓ Emergency unlocking for safety system MGB



112989 MGB-A-EMERGENCYRELEASE-112989

- ✓ Features

- › Quick emergency unlocking
 - › sealable
-

▼ Door handle for MGB-E...



110276 MGB-A-DOORHANDLE-R1-110276

▼ Features

- › Aluminum, red painted
 - › For mounting on all MGB escape release modules MGB-E
-

▼ Door knob for MGB-E...



114904 MGB-A-DOORKNOB-R1-114904

▼ Features

- › Aluminum, red painted
 - › For mounting on all MGB escape release modules MGB-E
 - › e.g. on sliding doors
-

▼ Door handle for MGB-H...



123926 MGB-A-DOORHANDLE-S2-123926

▼ Features

- › Aluminum silver anodized
 - › For mounting on all MGB handle modules MGB-H from V3.0.0
-

▼ Extended actuation axis for MGB-E...



106761 AY-ERS-250-106761

Mounting accessories

▼ Mounting plate for evaluation modules MGB-L.-AR.-... and MGB-L.-AP.-...



109490 MGB-A-MOUNTINGPLATE-L-109490

▼ Features

- › Easy and quick mounting (only two screws required)
 - › Quick module replacement
 - › Steel, powder-coated
 - › Suitable for doors hinged on the right or left
-

▼ Mounting plate for all MGB handle modules



109491 MGB-A-MOUNTINGPLATE-H-109491

▼ Features

- › Easy and quick mounting (only two screws required)
- › Quick module replacement
- › Steel, powder-coated
- › Suitable for doors hinged on the right or left

▼ Mounting plate for escape release



109492 MGB-A-MOUNTINGPLATE-E-109492

▼ Features

- › Easy and quick mounting (only two screws required)
 - › Quick module replacement
 - › Steel, powder-coated
 - › Suitable for doors hinged on the right or left
-

Miscellaneous accessories

▼ Lens set 5 colors



120344 AY-SET-LNS-0001-120344

▼ Lens set 6 colors



120378 AY-SET-LNS-0002-120378

▼ Lens set labeled



120377 AY-SET-LNS-SY01-120377



125359 AY-SET-LNS-SY02-125359



126158 AY-SET-LNS-SY03-126158

▼ Lens set, three colors



158307 AY-SET-LNS-SY04-158307

Connection material

▼ Connection cable with plug connector M12, 5-pin, 50m



156064 C-M12F05-05X034PV50,0-MA-156064

▼ Features

- › M12 female plug, 5-pin
- › Straight plug connector
- › PVC cable
- › Cable length 50 m
- › With flying lead

-
- ▼ Connection cable with plug connector M12, 5-pin, 20m



100185 C-M12F05-05X034PV20,0-MA-100185

▼ Features

- › M12 female plug, 5-pin
- › Straight plug connector
- › PVC cable
- › Cable length 20 m
- › With flying lead

-
- ▼ Connection cable with plug connector M12, 5-pin, 10m



100184 C-M12F05-05X034PV10,0-MA-100184

▼ Features

- › M12 female plug, 5-pin
- › Straight plug connector
- › PVC cable
- › Cable length 10 m
- › With flying lead

-
- ▼ Connection cable with straight plug connector M12, 5-pin, 5m



100183 C-M12F05-05X034PV05,0-MA-100183

▼ Features

- › M12 female plug, 5-pin
- › Straight plug connector
- › PVC cable
- › Cable length 5 m
- › With flying lead



113620 C-M12F05-05X034PU05,0-MA-113620

▼ Features

- › M12 female plug, 5-pin
- › Straight plug connector
- › PUR cable
- › Cable length 5 m
- › With flying lead

-
- ▼ Connection cable with 2 plug connectors M12, 5-pin, 20m



100182 C-M12F05-05X034PV20,0-M12M05-100182

▼ Features

- › M12 female plug to M12 plug connector, 5-pin
- › Straight female plug and plug connector
- › PVC cable
- › Cable length 20 m



119971 C-M12F05-05X034PU20,0-M12M05-119971

▼ Features

- › M12 female plug to M12 plug connector, 5-pin
- › Straight female plug and plug connector

- › PUR cable
 - › Cable length 20 m
-

▼ Connection cable with 2 plug connectors M12, 5-pin, 10m



100181 C-M12F05-05X034PV10,0-M12M05-100181

▼ Features

- › M12 female plug to M12 plug connector, 5-pin
 - › Straight female plug and plug connector
 - › PVC cable
 - › Cable length 10 m
-



119947 C-M12F05-05X034PU10,0-M12M05-119947

▼ Features

- › M12 female plug to M12 plug connector, 5-pin
 - › Straight female plug and plug connector
 - › PUR cable
 - › Cable length 10 m
-

▼ Connection cable with 2 plug connectors M12, 5-pin, 5m



100180 C-M12F05-05X034PV05,0-M12M05-100180

▼ Features

- › M12 female plug to M12 plug connector, 5-pin
 - › Straight female plug and plug connector
 - › PVC cable
 - › Cable length 5 m
-



119932 C-M12F05-05X034PU05,0-M12M05-119932

▼ Features

- › M12 female plug to M12 plug connector, 5-pin
 - › Straight female plug and plug connector
 - › PUR cable
 - › Cable length 5 m
-

▼ Connection cable with straight plug connector M12, 5-pin, 30 m



122784 C-M12F05-05X034PU30,0-MA-122784

▼ Features

- › M12 female plug, 5-pin
 - › Straight plug connector
 - › PUR cable
 - › Cable length 30 m
 - › With flying lead
-

▼ Connection cable with straight plug connector M12, 5-pin, 20 m



113682 C-M12F05-05X034PU20,0-MA-113682

▼ Features

- › M12 female plug, 5-pin
- › Straight plug connector

- › PUR cable
 - › Cable length 20 m
 - › With flying lead
-

▼ Connection cable with straight plug connector M12, 5-pin, 10m



113640 C-M12F05-05X034PU10,0-MA-113640

▼ Features

- › M12 female plug, 5-pin
 - › Straight plug connector
 - › PUR cable
 - › Cable length 10 m
 - › With flying lead
-

▼ Connecting cable with plug connector M12, 8-pin, 40 m



156065 C-M12F08-08X025PV40,0-MA-156065

▼ Features

- › M12 female plug, 8-pin
 - › Straight plug connector
 - › PVC cable
 - › Cable length 40 m
 - › With flying lead
-

▼ Connection cable with plug connector M12, 8-pin, 30m



115116 C-M12F08-08X025PV30,0-MA-115116

▼ Features

- › M12 female plug, 8-pin
 - › Straight plug connector
 - › PVC cable
 - › Cable length 30 m
 - › With flying lead
-



115257 C-M12F08-08X025PU30,0-MA-115257

▼ Features

- › M12 female plug, 8-pin
 - › Straight plug connector
 - › PUR cable
 - › Cable length 30 m
 - › With flying lead
-

▼ Connection cable with plug connector M12, 8-pin, 20m



100179 C-M12F08-08X025PV20,0-MA-100179

▼ Features

- › M12 female plug, 8-pin
 - › Straight plug connector
 - › PVC cable
 - › Cable length 20 m
 - › With flying lead
-



115114 C-M12F08-08X025PU20,0-MA-115114

▼ Features

- › M12 female plug, 8-pin
 - › Straight plug connector
 - › PUR cable
 - › Cable length 20 m
 - › With flying lead
-

▼ Connection cable with plug connector M12, 8-pin, 10m



100178 C-M12F08-08X025PV10,0-MA-100178

▼ Features

- › M12 female plug, 8-pin
 - › Straight plug connector
 - › PVC cable
 - › Cable length 10 m
 - › With flying lead
-



115113 C-M12F08-08X025PU10,0-MA-115113

▼ Features

- › M12 female plug, 8-pin
 - › Straight plug connector
 - › PUR cable
 - › Cable length 10 m
 - › With flying lead
-

▼ Connection cable with plug connector M12, 8-pin, 5m



100177 C-M12F08-08X025PV05,0-MA-100177

▼ Features

- › M12 female plug, 8-pin
 - › Straight plug connector
 - › PVC cable
 - › Cable length 5 m
 - › With flying lead
-



115112 C-M12F08-08X025PU05,0-MA-115112

▼ Features

- › M12 female plug, 8-pin
 - › Straight plug connector
 - › PUR cable
 - › Cable length 5 m
 - › With flying lead
-

























Instructions

- ▼ Návod k použití – bezpečnostní systémy MGB-L1...AR.-... / MGB-L2...AR.-... a MGB-L1...AP.-... / MGB-L2...AP.-... od V3.0.0

	Doc. no.	Version	Language	Download
Betriebsanleitung MGB-L1...AR.-... / MGB-L2...AR.-... und MGB-L1...AP.-... / MGB-L2...AP.-... ab V3.0.0	2119167	04-05/18		 3.7 MB
Mode d'emploi MGB-L1...AR.-... / MGB-L2...AR.-... et MGB-L1...AP.-... / MGB-L2...AP.-... à partir de V3.0.0	2119167	04-05/18		 3.7 MB
Manual de instrucciones MGB-L1...AR.-... / MGB-L2...AR.-... y MGB-L1...AP.-... / MGB-L2...AP.-... V3.0.0 o superior	2119167	04-05/18		 3.7 MB
Návod k použití – bezpečnostní systémy MGB-L1...AR.-... / MGB-L2...AR.-... a MGB-L1...AP.-... / MGB-L2...AP.-... od V3.0.0	2119167	04-05/18		 4.0 MB
Operating Instructions MGB-L1...AR.-... / MGB-L2...AR.-... and MGB-L1...AP.-... / MGB-L2...AP.-... from V3.0.0	2119167	04-05/18		 3.7 MB
Istruzioni di impiego MGB-L1...AR.-... / MGB-L2...AR.-... und MGB-L1...AP.-... / MGB-L2...AP.-... da V3.0.0	2119167	04-05/18		 3.7 MB
Handleiding MGB-L1...AR.-... / MGB-L2...AR.-... en MGB-L1...AP.-... / MGB-L2...AP.-... vanaf V3.0.0	2119167	04-05/18		 3.7 MB
Instrukcja obsługi MGB-L1...AR.-... / MGB-L2...AR.-... i MGB-L1...AP.-... / MGB-L2...AP.-... od V3.0.0	2119167	04-05/18		 4.0 MB
Manual de instruções MGB-L1...AR.-... / MGB-L2...AR.-... e MGB-L1...AP.-... / MGB-L2...AP.-... a partir de V3.0.0	2119167	04-05/18		 3.7 MB
Инструкция по эксплуатации MGB-L1...AR.-... / MGB-L2...AR.-... и MGB-L1...AP.-... / MGB-L2...AP.-... с V3.0.0	2119167	04-05/18		 4.2 MB
Návod na prevádzku Bezpečnostné systémy MGB-L1...AR.-... / MGB-L2...AR.-... a MGB-L1...AP.-... / MGB-L2...AP.-... od V3.0.0	2119167	04-05/18		 4.0 MB
Instruktionsbok MGB-L1...AR.-... / MGB-L2...AR.-... och MGB-L1...AP.-... / MGB-L2...AP.-... fr. V3.0.0	2119167	04-05/18		 3.7 MB
İşletim kılavuzu MGB-L1...AR.-... / MGB-L2...AR.-... ve MGB-L1...AP.-... / MGB-L2...AP.-... itibaren V3.0.0	2119167	04-05/18		 4.1 MB
操作指示書 安全システム MGB-L1...-AR.-... / MGB-L2...-AR.-... および MGB-L1...-AP.-... / MGB-L2...-AP.-... V3.0.0以降	2119167	04-05/18		 4.1 MB
使用说明书 安全系统 MGB-L1...-AR.-... / MGB-L2...-AR.-...和MGB-L1...-AP.-... / MGB-L2...-AP.-... V3.0.0以上	2119167	04-05/18		 4.1 MB







 Sicherheitsinformation (Teil der Betriebsanleitung Sicherheitssystem MGB-AR/MGB-AP) ab V3.0.0

Doc. no. **Version** **Language** **Download**

Sicherheitsinformation (Teil der Betriebsanleitung Sicherheitssystem MGB-AR/MGB-AP) ab V3.0.0 Información de seguridad (parte del manual de instrucciones Sistema de seguridad MGB-AR/MGB-AP) V3.0.0 o superior Information de sécurité (partie du mode d'emploi Système de sécurité MGB-AR/MGB-AP) à partir de V3.0.0 Informazioni sulla sicurezza (Parte delle istruzioni di impiego Sistema di sicurezza MGB-AR/MGB-AP) da V3.0.0 Säkerhetsinformation (Del av instruktionsboken Säkerhetssystem MGB-AR/MGB-AP) från V3.0.0 Safety Information (Part of the Operating Instructions Safety System MGB-AR/MGB-AP) from V3.0.0	123151	01-02/15	     	 0.6 MB
Veiligheidsinformatie (Deel van de handleiding Beveiligingssysteem MGB-AR/MGB-AP) vanaf V3.0.0	123151	01-02/15		 0.2 MB
Informação de segurança (Parte do manual de instruções Sistema de segurança MGB-AR/MGB-AP) a partir de V3.0.0	123151	01-02/15		 0.2 MB
Bezpečnostní informace (součást návodu k použití „Bezpečnostní systém MGB-AR/MGB-AP“) od V3.0.0	123151	01-02/15		 0.2 MB
Informacje o bezpieczeństwie (Część instrukcji obsługi System bezpieczeństwa MGB-AR/MGB-AP) od V3.0.0	123151	01-02/15		 0.2 MB
Информация о безопасности (часть инструкции по эксплуатации Предохранительная система MGB-AR/MGB-AP) с V3.0.0	123151	01-02/15		 0.3 MB
Bezpečnostná informácia (časť návodu na prevádzku Bezpečnostný systém MGB-AR/MGB-AP) od V3.0.0	123151	01-02/15		 0.2 MB
Güvenlik bilgisi (İşletim kılavuzunun parçası emniyet sistemi MGB-AR/MGB-AP) V3.0.0 ve üstü	123151	01-02/15		 0.3 MB
安全信息 (安全系统 MGB-AR/MGB-AP使用说明书的组成部分) V3.0.0以上	123151	01-02/15		 0.3 MB
安全情報 MGB-AR/MGB-AP	123151	01-02/15		 0.6 MB

Declaration of conformity

EU-Konformitätserklärung

	Doc. no.	Version	Language	Download
EU-Konformitätserklärung Declaración UE de conformidad Déclaration UE de conformité Dichiarazione di conformità EU declaration of conformity	2123150	08-01/17	    	 0.3 MB