

## ITEM 158120 MGB-L1HE-APA-L-158120

Description	Technical data	Accessories	Downloads
-------------	----------------	-------------	-----------

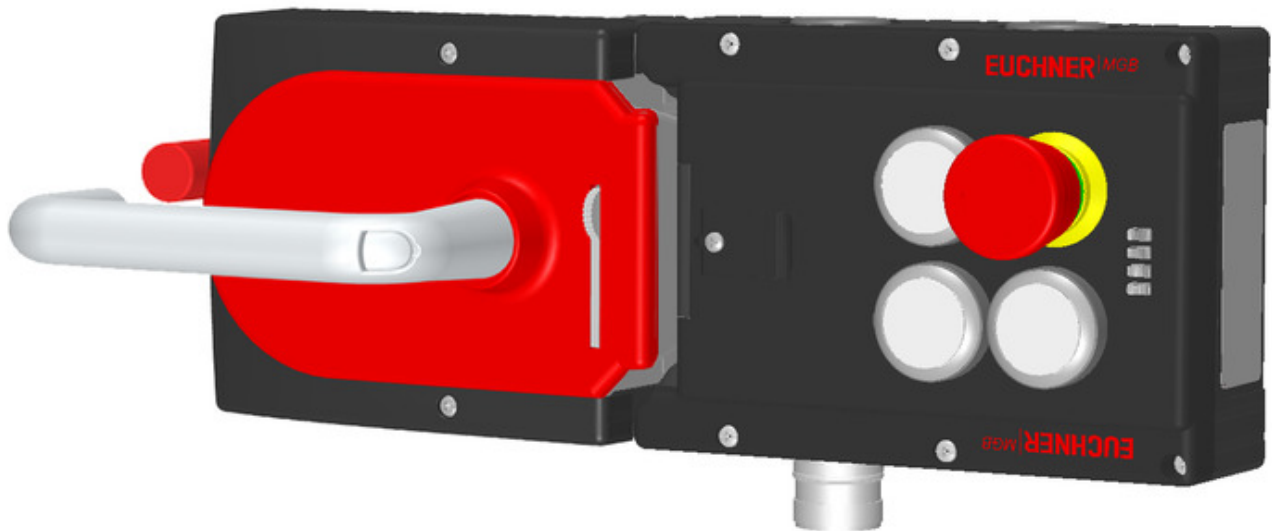

### Features

- › Guard locking with guard locking monitoring
- › Emergency stop according to ISO 13850
- › Three pushbuttons, illuminated
- › With lens set, six pcs.
- › With plug connector RC18
- › With escape release
- › Unicode

### Guard locking type

**MGB-** The locking arm is held in the locked position by spring force and is **L1...** unlocked by solenoid force (closed-circuit current principle, mechanically locked).

### Door stop

A mechanical door stop is permanently integrated into the evaluation module of the MGB. A marking on the stop makes adjustment easier.

### LED indicator

The LED indicator indicates all important system and status information.

---

### Monitoring outputs

- OT** Bolt tongue inserted in the evaluation module
  - OI** Diagnostics; there is a fault
- 

### Emergency stop device

- S1** Two positively driven contacts, emergency stop with turn-to-reset, not illuminated
- 

### Pushbutton

- S2** One NO contact, illuminated
  - S3** One NO contact, illuminated
  - S4** One NO contact, illuminated
- 

### Escape release

The escape release enables people shut in to open the guard locked door from the danger zone.

### Components included in the set



158119 Locking module MGB-L1-APA-AP4A1-S1-L-158119  
Features

---



111158 Handle module MGB-H-AA1A3-L-111158  
Features

---



100465 Escape release MGB-E-A-100465  
Features

---

Dimension drawing

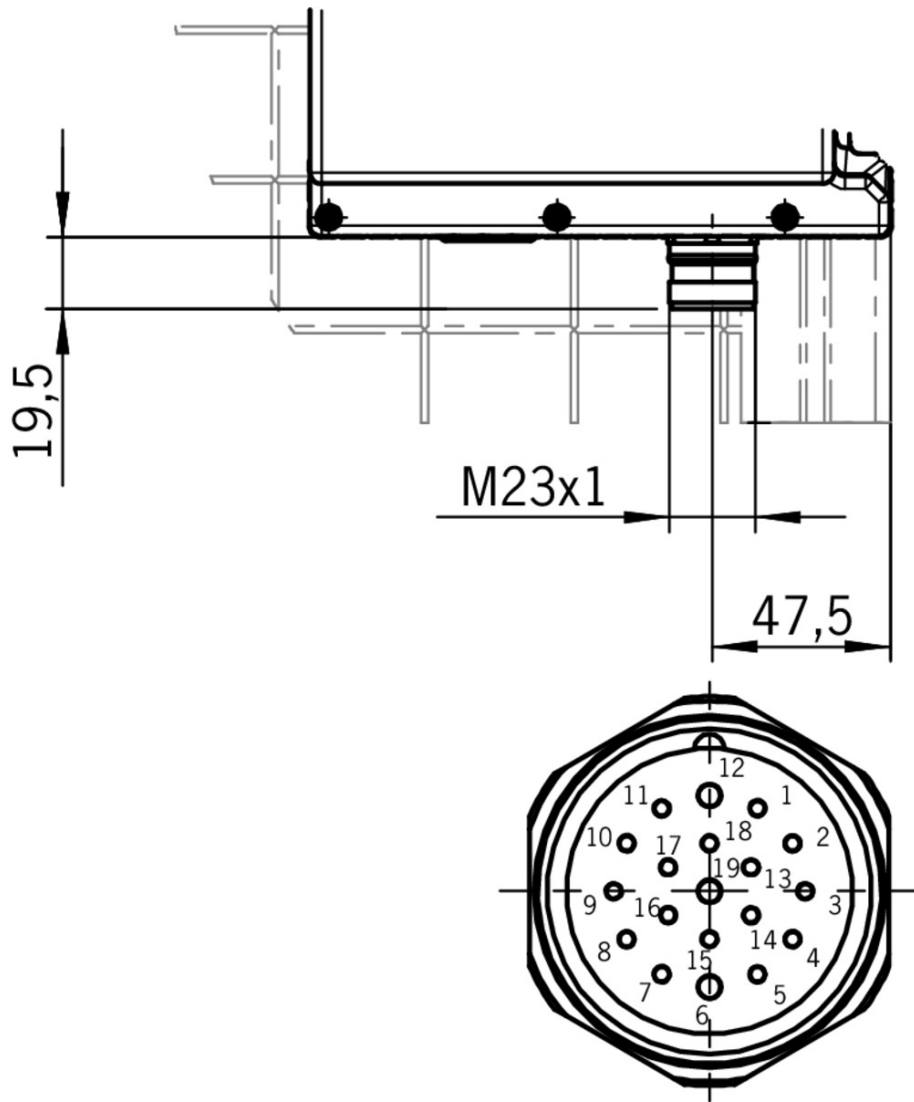

## Dimension drawing

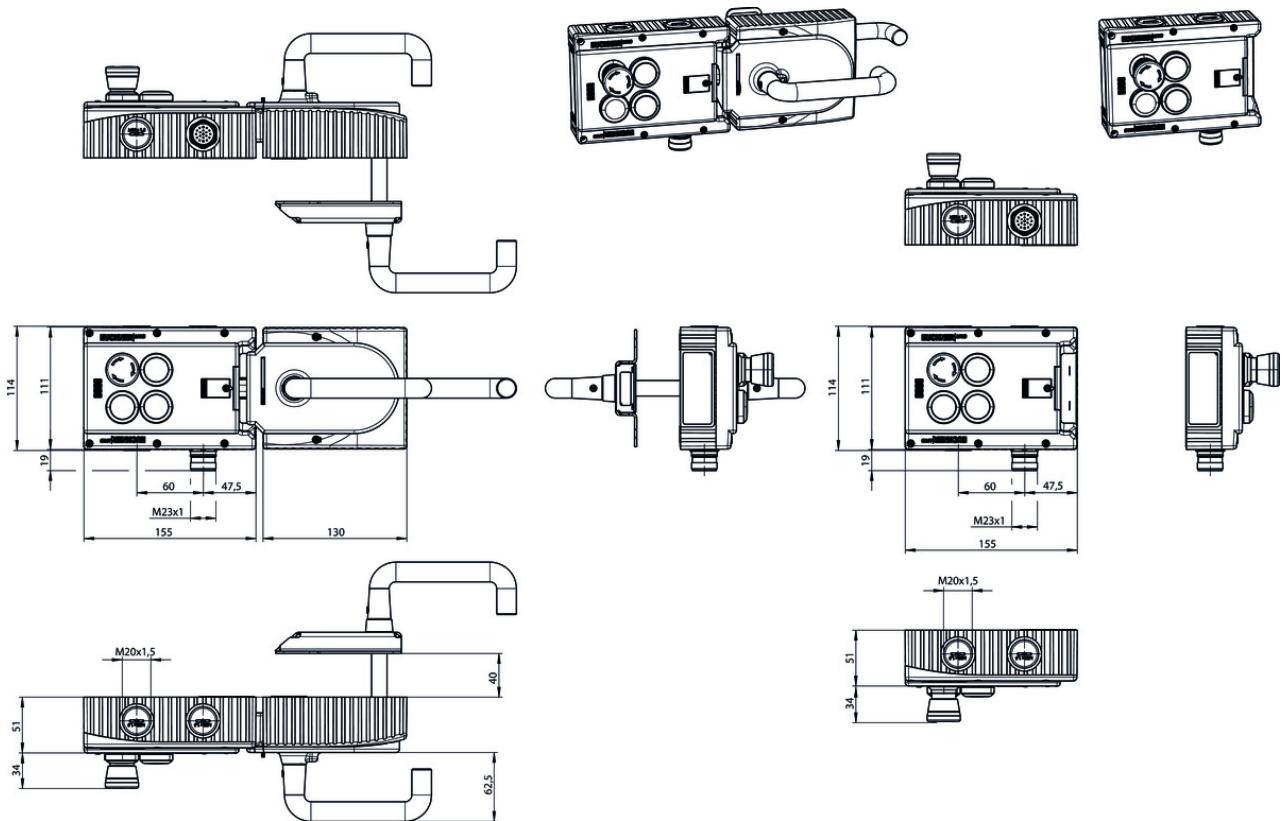

## Plug connector RC18

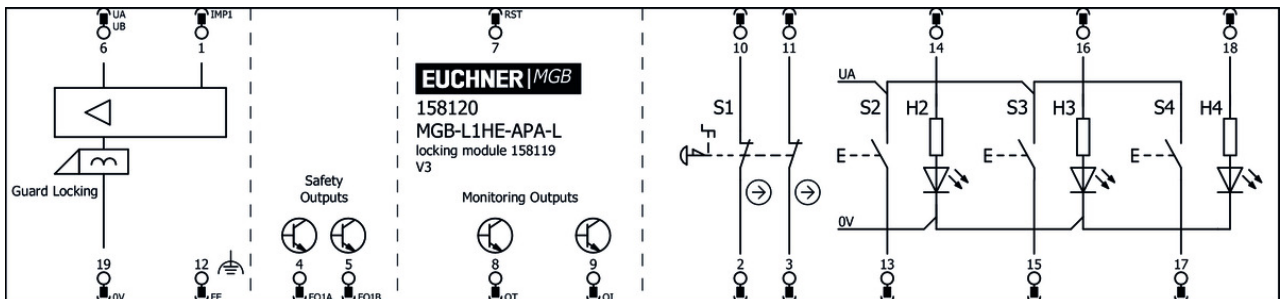

## Connection material

- ▼ Female plug RC18 straight with option C1825



**077025** RC18EF-C1825

- ▼ Features

- › Plug connector M23, straight
- › Number of pins: 19-pin with screen bonding clamp

- ▼ Connection cable with plug connector M23 with option C1825, 3m, straight



**092816** C-M23F19-19XDIFPU03,0-MA-092816

- ▼ Features

- › M23 plug connector, 18-pin + PE
- › Straight plug connector

- › PUR cable
  - › Cable length 3 m
  - › With flying lead
  - › Cores color-coded
- 

▼ Connection cable with plug connector M23 with option C1825, 15m, straight



**077016** C-M23F19-19XDIFPU15,0-MA-077016

▼ Features

- › M23 plug connector, 18-pin + PE
  - › Straight plug connector
  - › PUR cable
  - › Cable length 15 m
  - › With flying lead
  - › Cores color-coded
- 

▼ Connection cable with plug connector M23 with option C1825, 40m, straight



**102490** C-M23F19-19XDIFPU40,0-MA-102490

▼ Features

- › M23 plug connector, 18-pin + PE
  - › Straight plug connector
  - › PUR cable
  - › Cable length 40 m
  - › With flying lead
  - › Cores color-coded
- 

▼ Connection cable with plug connector M23 with option C1825, 6m, straight



**077014** C-M23F19-19XDIFPU06,0-MA-077014

▼ Features

- › M23 plug connector, 18-pin + PE
  - › Straight plug connector
  - › PUR cable
  - › Cable length 6 m
  - › With flying lead
  - › Cores color-coded
- 

▼ Connection cable with plug connector M23 with option C1825, 20m, straight



**092726** C-M23F19-19XDIFPU20,0-MA-092726

▼ Features

- › M23 plug connector, 18-pin + PE
  - › Straight plug connector
  - › PUR cable
  - › Cable length 20 m
  - › With flying lead
  - › Cores color-coded
- 

▼ Connection cable with plug connector M23 with option C1825, 8m, straight

**077015** C-M23F19-19XDIFPU08,0-MA-077015



- ▼ Features
    - › M23 plug connector, 18-pin + PE
    - › Straight plug connector
    - › PUR cable
    - › Cable length 8 m
    - › With flying lead
    - › Cores color-coded
- 

- ▼ Connection cable with plug connector M23 with option C1825, 25m, straight



**092727** C-M23F19-19XDIFPU25,0-MA-092727

- ▼ Features
    - › M23 plug connector, 18-pin + PE
    - › Straight plug connector
    - › PUR cable
    - › Cable length 25 m
    - › With flying lead
    - › Cores color-coded
- 

- ▼ Connection cable with plug connector M23 with option C1825, 1.5m, straight



**092761** C-M23F19-19XDIFPU01,5-MA-092761

- ▼ Features
    - › M23 plug connector, 18-pin + PE
    - › Straight plug connector
    - › PUR cable
    - › Cable length 1.5 m
    - › With flying lead
    - › Cores color-coded
- 

- ▼ Connection cable with plug connector M23 with option C1825, 10m, straight



**092898** C-M23F19-19XDIFPU10,0-MA-092898

- ▼ Features
    - › M23 plug connector, 18-pin + PE
    - › Straight plug connector
    - › PUR cable
    - › Cable length 10 m
    - › With flying lead
    - › Cores color-coded
- 

- ▼ Connection cable with plug connector M23 with option C1825, 30m, straight



**095993** C-M23F19-19XDIFPU30,0-MA-095993

- ▼ Features
    - › M23 plug connector, 18-pin + PE
    - › Straight plug connector
    - › PUR cable
    - › Cable length 30 m
    - › With flying lead
    - › Cores color-coded
-

- ▼ Replacement crimp contacts for female connector RC18 with option C1825

**094310** CRIMPKONTAKT BUCHSE RCF-C1825

▼ Features

- › 19 crimp sockets
- › Conductor cross-section 16 x 0.25 - 0.5 mm<sup>2</sup> and 3 x 0.75 - 1 mm<sup>2</sup>
- › For plug connector RC18..C1825

---

## Spare parts

- ▼ Locking module MGB-L1-APA..., (guard locking by spring force) with 3 push buttons, emergency stop, RC18



**158119** MGB-L1-APA-AP4A1-S1-L-158119

▼ Features

- › Guard locking with guard locking monitoring
- › Emergency stop according to ISO 13850
- › Three pushbuttons (illuminated)
- › With lens set, six pcs.
- › With plug connector RC18
- › Unicode

---

## Miscellaneous accessories

- ▼ Lens set labeled



**125359** AY-SET-LNS-SY02-125359



**126158** AY-SET-LNS-SY03-126158



**120377** AY-SET-LNS-SY01-120377

- ▼ Lens set 6 colors



**120378** AY-SET-LNS-0002-120378

- ▼ Lens set 5 colors



**120344** AY-SET-LNS-0001-120344

- ▼ Lens set, three colors



**158307** AY-SET-LNS-SY04-158307

---

## Mounting accessories

---

▼ Mounting plate for evaluation modules MGB-L.-AR.-... and MGB-L.-AP.-...



**109490** MGB-A-MOUNTINGPLATE-L-109490

▼ Features

- › Easy and quick mounting (only two screws required)
  - › Quick module replacement
  - › Steel, powder-coated
  - › Suitable for doors hinged on the right or left
- 

▼ Mounting plate for all MGB handle modules



**109491** MGB-A-MOUNTINGPLATE-H-109491

▼ Features

- › Easy and quick mounting (only two screws required)
  - › Quick module replacement
  - › Steel, powder-coated
  - › Suitable for doors hinged on the right or left
- 

## Function expansion

---

▼ Door handle for MGB-H...



**110277** MGB-A-DOORHANDLE-S1-110277

▼ Features

- › Aluminum silver anodized
  - › For mounting on all MGB handle modules MGB-H up to V2.0.0
- 



**123926** MGB-A-DOORHANDLE-S2-123926

▼ Features

- › Aluminum silver anodized
  - › For mounting on all MGB handle modules MGB-H from V3.0.0
- 

▼ Door knob for MGB-H...



**111460** MGB-A-DOORKNOB-S1-111460

▼ Features

- › Aluminum, silver anodized
  - › For mounting on all MGB handle modules MGB-H... up to V2.0.0
  - › e.g. on sliding doors
- 



**124030** MGB-A-DOORKNOB-S2-124030

▼ Features

- › Aluminum, silver anodized
  - › For mounting on all MGB handle modules MGB-H... from V3.0.0
  - › e.g. on sliding doors
-

## Emergency unlocking for safety system MGB



**112989** MGB-A-EMERGENCYRELEASE-112989

### Features

- › Quick emergency unlocking
- › sealable

## Escape release MGB-E-A...



**100465** MGB-E-A-100465

### Features

- › Escape release from the danger zone
- › Door handle signal red
- › Extended actuation axis for thicker doors (available optionally)

## Extended actuation axis for MGB-E...









**106761** AY-ERS-250-106761

## Instructions











### Návod k použití – bezpečnostní systémy MGB-L1...AR.-... / MGB-L2...AR.-... a MGB-L1...AP.-... / MGB-L2...AP.-... od V3.0.0

	Doc. no.	Version	Language	Download
Betriebsanleitung MGB-L1...AR.-... / MGB-L2...AR.-... und MGB-L1...AP.-... / MGB-L2...AP.-... ab V3.0.0	2119167	04-05/18		3.7 MB
Mode d'emploi MGB-L1...AR.-... / MGB-L2...AR.-... et MGB-L1...AP.-... / MGB-L2...AP.-... à partir de V3.0.0	2119167	04-05/18		3.7 MB
Manual de instrucciones MGB-L1...AR.-... / MGB-L2...AR.-... y MGB-L1...AP.-... / MGB-L2...AP.-... V3.0.0 o superior	2119167	04-05/18		3.7 MB
Návod k použití – bezpečnostní systémy MGB-L1...AR.-... / MGB-L2...AR.-... a MGB-L1...AP.-... / MGB-L2...AP.-... od V3.0.0	2119167	04-05/18		4.0 MB
Operating Instructions MGB-L1...AR.-... / MGB-L2...AR.-... and MGB-L1...AP.-... / MGB-L2...AP.-... from V3.0.0	2119167	04-05/18		3.7 MB
Istruzioni di impiego MGB-L1...AR.-... / MGB-L2...AR.-... und MGB-L1...AP.-... / MGB-L2...AP.-... da V3.0.0	2119167	04-05/18		3.7 MB
Handleiding MGB-L1...AR.-... / MGB-L2...AR.-... en MGB-L1...AP.-... / MGB-L2...AP.-... vanaf V3.0.0	2119167	04-05/18		3.7 MB
Instrukcja obsługi MGB-L1...AR.-... / MGB-L2...AR.-... i MGB-L1...AP.-... / MGB-L2...AP.-... od V3.0.0	2119167	04-05/18		4.0 MB

Manual de instruções MGB-L1...AR-... / MGB-L2...AR-... e MGB-L1...AP-... / MGB-L2...AP-... a partir de V3.0.0	2119167	04-05/18		 3.7 MB
Инструкция по эксплуатации MGB-L1...AR-... / MGB-L2...AR-... и MGB-L1...AP-... / MGB-L2...AP-... с V3.0.0	2119167	04-05/18		 4.2 MB
Návod na prevádzku Bezpečnostné systémy MGB-L1...AR-... / MGB-L2...AR-... a MGB-L1...AP-... / MGB-L2...AP-... od V3.0.0	2119167	04-05/18		 4.0 MB
Instruktionsbok MGB-L1...AR-... / MGB-L2...AR-... och MGB-L1...AP-... / MGB-L2...AP-... fr. V3.0.0	2119167	04-05/18		 3.7 MB
İşletim kılavuzu MGB-L1...AR-... / MGB-L2...AR-... ve MGB-L1...AP-... / MGB-L2...AP-... itibaren V3.0.0	2119167	04-05/18		 4.1 MB
操作指示書 安全システム MGB-L1...-AR-... / MGB-L2...-AR-... および MGB-L1...-AP-... / MGB-L2...-AP-... V3.0.0以降	2119167	04-05/18		 4.1 MB
使用说明书 安全系统 MGB-L1...-AR-... / MGB-L2...-AR-...和MGB-L1...-AP-... / MGB-L2...-AP-... V3.0.0以上	2119167	04-05/18		 4.1 MB







 **Sicherheitsinformation (Teil der Betriebsanleitung Sicherheitssystem MGB-AR/MGB-AP) ab V3.0.0**

	<b>Doc. no.</b>	<b>Version</b>	<b>Language</b>	<b>Download</b>
Sicherheitsinformation (Teil der Betriebsanleitung Sicherheitssystem MGB-AR/MGB-AP) ab V3.0.0 Safety Information (Part of the Operating Instructions Safety System MGB-AR/MGB-AP) from V3.0.0 Información de seguridad (parte del manual de instrucciones Sistema de seguridad MGB-AR/MGB-AP) V3.0.0 o superior Information de sécurité (partie du mode d'emploi Système de sécurité MGB-AR/MGB-AP) à partir de V3.0.0 Informazioni sulla sicurezza (Parte delle istruzioni di impiego Sistema di sicurezza MGB-AR/MGB-AP) da V3.0.0 Säkerhetsinformation (Del av instruktionsboken Säkerhetssystem MGB-AR/MGB-AP) från V3.0.0	123151	01-02/15	     	 0.6 MB
Veiligheidsinformatie (Deel van de handleiding Beveiligingssysteem MGB-AR/MGB-AP) vanaf V3.0.0	123151	01-02/15		 0.2 MB
Informação de segurança (Parte do manual de instruções Sistema de segurança MGB-AR/MGB-AP) a partir de V3.0.0	123151	01-02/15		 0.2 MB
Bezpečnostní informace (součást návodu k použití „Bezpečnostní systém MGB-AR/MGB-AP“) od V3.0.0	123151	01-02/15		 0.2 MB
Informacje o bezpieczeństwie (Część instrukcji obsługi System bezpieczeństwa MGB-AR/MGB-AP) od V3.0.0	123151	01-02/15		 0.2 MB

Информация о безопасности (часть инструкции по эксплуатации Предохранительная система MGB-AR/MGB-AP) с V3.0.0	123151	01-02/15		 0.3 MB
Bezpečnostná informácia (časť návodu na prevádzku Bezpečnostný systém MGB-AR/MGB-AP) od V3.0.0	123151	01-02/15		 0.2 MB
Güvenlik bilgisi (İşletim kılavuzunun parçası emniyet sistemi MGB-AR/MGB-AP) V3.0.0 ve üstü	123151	01-02/15		 0.3 MB
安全信息 (安全系统 MGB-AR/MGB-AP使用说明书的组成部分) V3.0.0以上	123151	01-02/15		 0.3 MB
安全情報 MGB-AR/MGB-AP	123151	01-02/15		 0.6 MB

## Declaration of conformity

### EU-Konformitätserklärung

	Doc. no.	Version	Language	Download
EU-Konformitätserklärung EU declaration of conformity Declaración UE de conformidad Déclaration UE de conformité Dichiarazione di conformità	2123150	08-01/17	    	 0.3 MB