

ITEM 105780 MGB-LOHE-ARA-R-105780

Description	Technical data	Accessories	Downloads
-------------	----------------	-------------	-----------

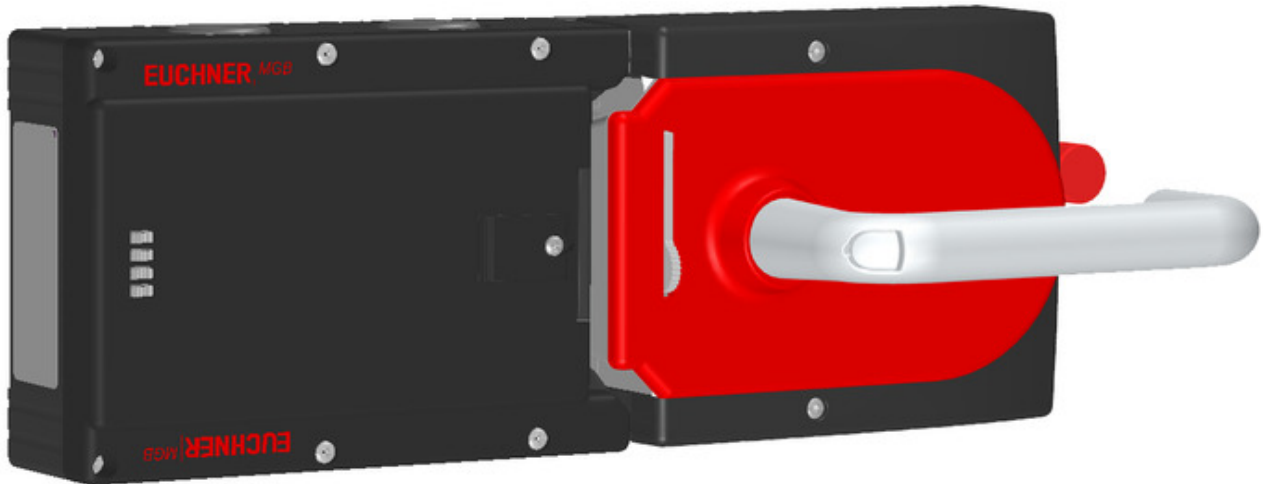

Features

- › Locking (without guard locking)
- › Can be connected in series with other AR devices (e.g. CES-AR and CET-AR)
- › With cable entry
- › With escape release
- › Unicode

Guard locking type

MGB-LO... The bolt tongue in the handle module is moved into and out of the interlocking module by actuating the door handle. The door arm is not locked in the locked position.

Door hinge

A mechanical door stop is permanently integrated into the evaluation module of the MGB. A marking on the stop makes adjustment easier.

LED indicator

The LED indicator indicates all important system and status information.

Monitoring outputs

- OD** ON when the door is closed
 - OT** Bolt tongue inserted in the evaluation module
 - OI** Diagnostics; there is a fault
-

Escape release

The escape release enables persons who are accidentally locked in to open the locked door from inside the danger area.

Components included in the set



105331 Interlocking module MGB-L0-ARA-AA1A1-M-105331
▼ Features



100464 Handle module MGB-H-AA1A1-R-100464
▼ Features



100465 Escape release MGB-E-A-100465
▼ Features

Dimension drawing

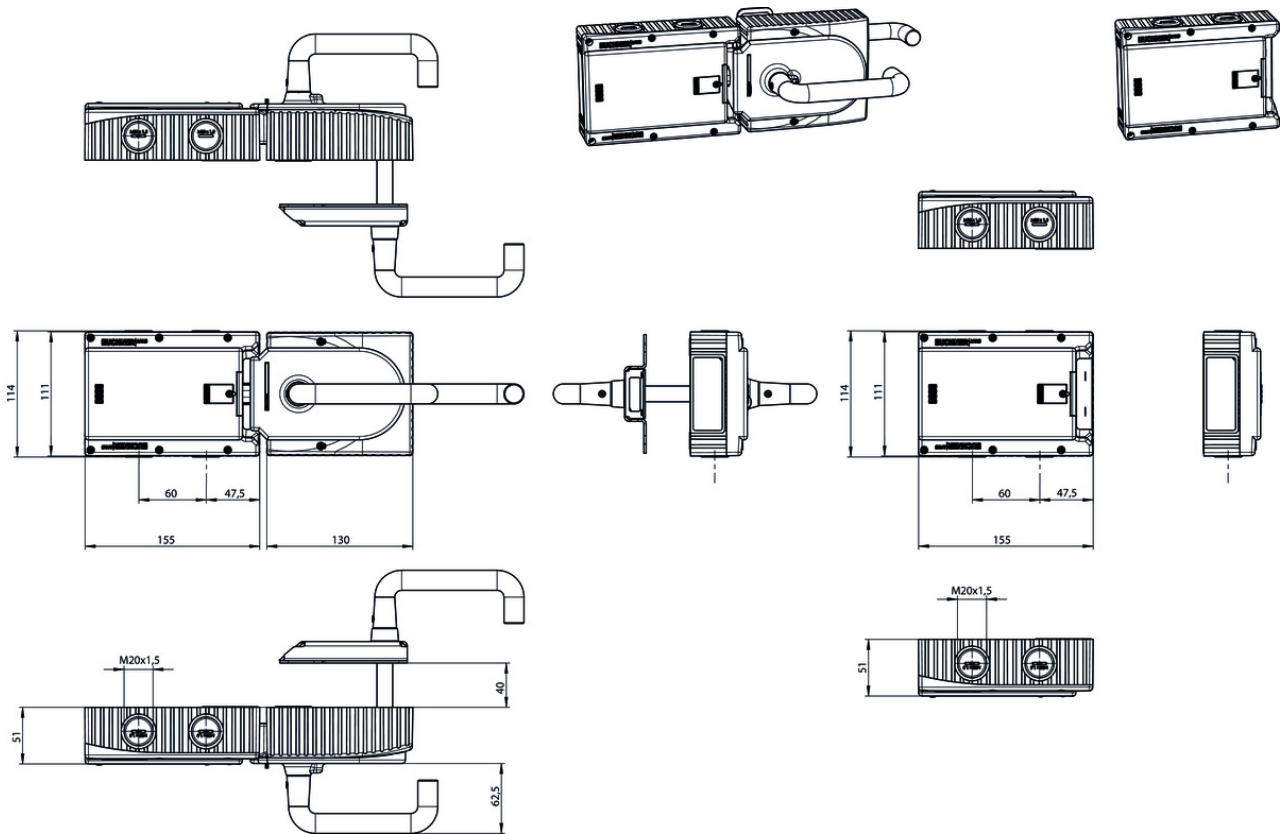

Cable entry

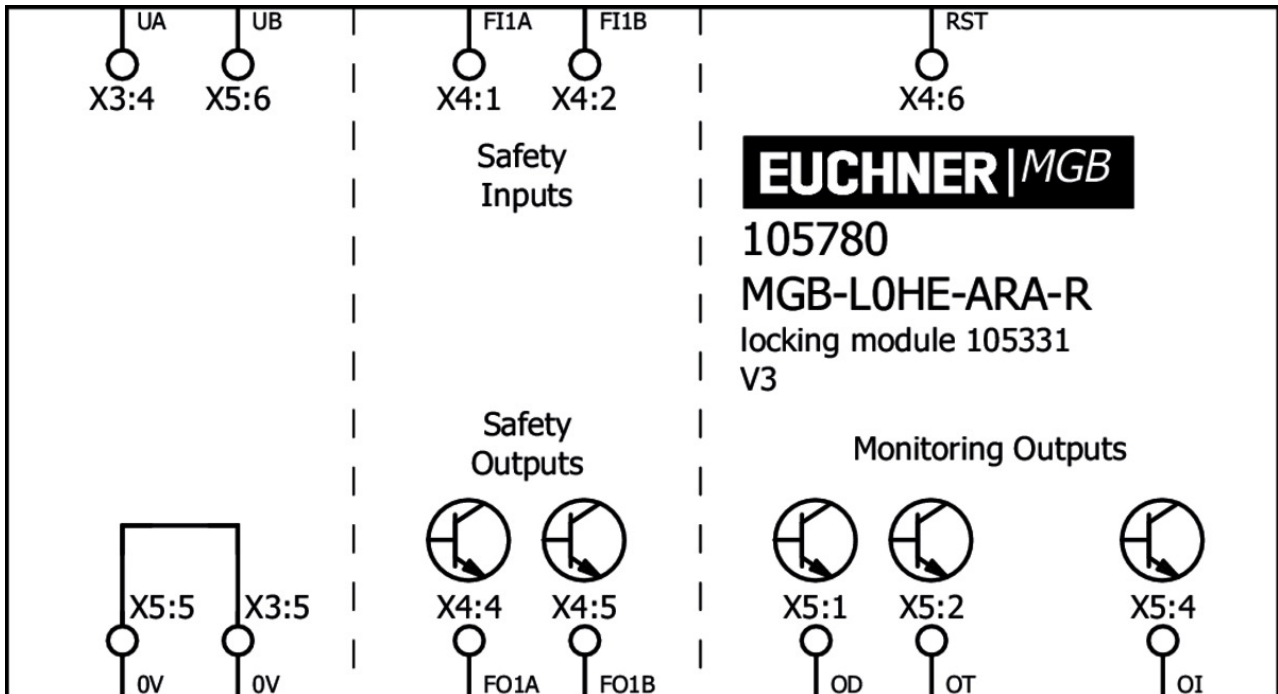

Spare parts

✓ Interlocking module MGB-L0-ARA..., without control or indicator

105331 MGB-L0-ARA-AA1A1-M-105331



- ✓ Features
 - › Locking (without guard locking)
 - › Can be connected in series with other AR devices (e.g. CES-AR and CET-AR)
 - › With cable entry
 - › Unicode
-

✓ Handle module MGB-H...



- 100464** MGB-H-AA1A1-R-100464
- ✓ Features
 - › Intelligent bolt tongue
 - › Lockout bar
 - › Door handle
-

Function expansion

✓ Door knob for MGB-H...



- 124030** MGB-A-DOORKNOB-S2-124030
- ✓ Features
 - › Aluminum, silver anodized
 - › For mounting on all MGB handle modules MGB-H... from V3.0.0
 - › e.g. on sliding doors
-



- 111460** MGB-A-DOORKNOB-S1-111460
- ✓ Features
 - › Aluminum, silver anodized
 - › For mounting on all MGB handle modules MGB-H... up to V2.0.0
 - › e.g. on sliding doors
-

✓ Emergency unlocking for safety system MGB



- 112989** MGB-A-EMERGENCYRELEASE-112989
- ✓ Features
 - › Quick emergency unlocking
 - › sealable
-

✓ Door handle for MGB-E...



- 110276** MGB-A-DOORHANDLE-R1-110276
- ✓ Features
 - › Aluminum, red painted
 - › For mounting on all MGB escape release modules MGB-E
-

✓ Door knob for MGB-E...



- 114904** MGB-A-DOORKNOB-R1-114904
- ✓ Features

- › Aluminum, red painted
 - › For mounting on all MGB escape release modules MGB-E
 - › e.g. on sliding doors
-

▼ Door handle for MGB-H...



110277 MGB-A-DOORHANDLE-S1-110277

▼ Features

- › Aluminum silver anodized
 - › For mounting on all MGB handle modules MGB-H up to V2.0.0
-



123926 MGB-A-DOORHANDLE-S2-123926

▼ Features

- › Aluminum silver anodized
 - › For mounting on all MGB handle modules MGB-H from V3.0.0
-

▼ Extended actuation axis for MGB-E...



106761 AY-ERS-250-106761

▼ Escape release MGB-E-A7...

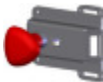

117126 MGB-E-A7-117126

▼ Features

- › Escape release from the danger zone
 - › Door knob signal red
 - › Extended actuation axis for thicker doors (available optionally)
-

▼ Escape release MGB-E-A...



100465 MGB-E-A-100465

▼ Features

- › Escape release from the danger zone
 - › Door handle signal red
 - › Extended actuation axis for thicker doors (available optionally)
-

Mounting accessories

▼ Mounting plate for evaluation modules MGB-L.-AR.-... and MGB-L.-AP.-...



109490 MGB-A-MOUNTINGPLATE-L-109490

▼ Features

- › Easy and quick mounting (only two screws required)
 - › Quick module replacement
 - › Steel, powder-coated
 - › Suitable for doors hinged on the right or left
-

▼ Mounting plate for escape release



109492 MGB-A-MOUNTINGPLATE-E-109492

▼ Features

- › Easy and quick mounting (only two screws required)
- › Quick module replacement
- › Steel, powder-coated
- › Suitable for doors hinged on the right or left

▼ Mounting plate for all MGB handle modules



109491 MGB-A-MOUNTINGPLATE-H-109491

▼ Features

- › Easy and quick mounting (only two screws required)
- › Quick module replacement
- › Steel, powder-coated
- › Suitable for doors hinged on the right or left

Connection material

▼ Built-in connector RC18

120403 MGB-A-PLUGCONNECTOR-RC18-120403

▼ Features

- › For all MGB with cable entry

Miscellaneous accessories

▼ Lens set labeled



126158 AY-SET-LNS-SY03-126158



120377 AY-SET-LNS-SY01-120377



125359 AY-SET-LNS-SY02-125359

▼ Lens set 5 colors



120344 AY-SET-LNS-0001-120344

▼ Lens set 6 colors



120378 AY-SET-LNS-0002-120378

























Instructions

▼ Návod k použití – bezpečnostní systémy MGB-L0...AR-... a MGB-L0...AP-... od V3.0.0

	Doc. no.	Version	Language	Download
Betriebsanleitung MGB-L0...AR-... und MGB-L0...AP-... ab V3.0.0	2112657	13-05/18		 2.9 MB
Mode d'emploi MGB-L0...AR-... et MGB-L0...AP-... à partir de V3.0.0	2112657	13-05/18		 3.0 MB
Manual de instrucciones MGB-L0...AR-... y MGB-L0...AP-... V3.0.0 o superior	2112657	13-05/18		 2.9 MB
Návod k použití – bezpečnostní systémy MGB-L0...AR-... a MGB-L0...AP-... od V3.0.0	2112657	13-05/18		 3.2 MB
Operating Instructions MGB-L0...AR-... and MGB-L0...AP-... from V3.0.0	2112657	13-05/18		 2.9 MB
Istruzioni di impiego per MGB-L0...AR-... e MGB-L0...AP-... da V3.0.0	2112657	13-05/18		 2.9 MB
Instrukcja obsługi MGB-L0...AR-... i MGB-L0...AP-... od V3.0.0	2112657	13-05/18		 3.2 MB
Manual de instruções MGB-L0...AR-... e MGB-L0...AP-... a partir de V3.0.0	2112657	13-05/18		 2.9 MB
Инструкция по эксплуатации MGB-L0...AR-... и MGB-L0...AP-... с V3.0.0	2112657	13-05/18		 3.4 MB
Instruktionsbok MGB-L0...AR-... och MGB-L0...AP-... fr. V3.0.0	2112657	13-05/18		 2.9 MB
操作指示書 安全システム MGB-L0...AR-... および MGB-L0...AP-... V3.0.0以降	2112657	13-05/18		 3.3 MB
使用说明书 安全系统 MGB-L0...AR-...和MGB-L0...AP-... V3.0.0以上	2112657	13-05/18		 3.3 MB









▼ Sicherheitsinformation (Teil der Betriebsanleitung Sicherheitssystem MGB-AR/MGB-AP) ab V3.0.0



Doc. no. Version Language Download

Sicherheitsinformation (Teil der Betriebsanleitung Sicherheitssystem MGB-AR/MGB-AP) ab V3.0.0 Información de seguridad (parte del manual de instrucciones Sistema de seguridad MGB-AR/MGB-AP) V3.0.0 o superior Information de sécurité (partie du mode d'emploi Système de sécurité MGB-AR/MGB-AP) à partir de V3.0.0 Informazioni sulla sicurezza (Parte delle istruzioni di impiego Sistema di sicurezza MGB-AR/MGB-AP) da V3.0.0 Säkerhetsinformation (Del av instruktionsboken Säkerhetssystem MGB-AR/MGB-AP) från V3.0.0 Safety Information (Part of the Operating Instructions Safety System MGB-AR/MGB-AP) from V3.0.0	123151	01-02/15	     	 0.6 MB
Veiligheidsinformatie (Deel van de handleiding Beveiligingssysteem MGB-AR/MGB-AP) vanaf V3.0.0	123151	01-02/15		 0.2 MB
Informação de segurança (Parte do manual de instruções Sistema de segurança MGB-AR/MGB-AP) a partir de V3.0.0	123151	01-02/15		 0.2 MB
Bezpečnostní informace (součást návodu k použití „Bezpečnostní systém MGB-AR/MGB-AP“) od V3.0.0	123151	01-02/15		 0.2 MB
Informacje o bezpieczeństwie (Część instrukcji obsługi System bezpieczeństwa MGB-AR/MGB-AP) od V3.0.0	123151	01-02/15		 0.2 MB
Информация о безопасности (часть инструкции по эксплуатации Предохранительная система MGB-AR/MGB-AP) с V3.0.0	123151	01-02/15		 0.3 MB
Bezpečnostná informácia (časť návodu na prevádzku Bezpečnostný systém MGB-AR/MGB-AP) od V3.0.0	123151	01-02/15		 0.2 MB
Güvenlik bilgisi (İşletim kılavuzunun parçası emniyet sistemi MGB-AR/MGB-AP) V3.0.0 ve üstü	123151	01-02/15		 0.3 MB
安全信息 (安全系统 MGB-AR/MGB-AP使用说明书的组成部分) V3.0.0以上	123151	01-02/15		 0.3 MB
安全情報 MGB-AR/MGB-AP	123151	01-02/15		 0.6 MB

Catalogs







 Multifunctional Gate Box MGB Multifunctional Gate Box MGB Multifunctional Gate Box MGB Multifunctional Gate Box MGB Multifunctional Gate Box MGB 多功能系统安全控制系统 MGB

	Doc. no.	Version	Language	Download
Multifunctional Gate Box MGB	106108	10-02/18		 8.2 MB
Multifunctional Gate Box MGB	109155	10-02/18		 8.2 MB
Multifunctional Gate Box MGB	114433	10-02/18		 8.3 MB
Multifunctional Gate Box MGB	121652	10-02/18		 8.0 MB

Multifunctional Gate Box MGB	106109	10-02/18		 8.2 MB
多功能系统安全控制系统 MGB	155883	10-02/18		 8.3 MB

Declaration of conformity

EU-Konformitätserklärung

	Doc. no.	Version	Language	Download
EU-Konformitätserklärung	2123150	08-01/17		 0.3 MB
Declaración UE de conformidad				
Déclaration UE de conformité				
Dichiarazione di conformità				
EU declaration of conformity				

CAD data

CAD data for this item on TraceParts