

ITEM 110256 MGB-LOHC-ARA-L-110256

Description	Technical data	Accessories	Downloads
-------------	----------------	-------------	-----------

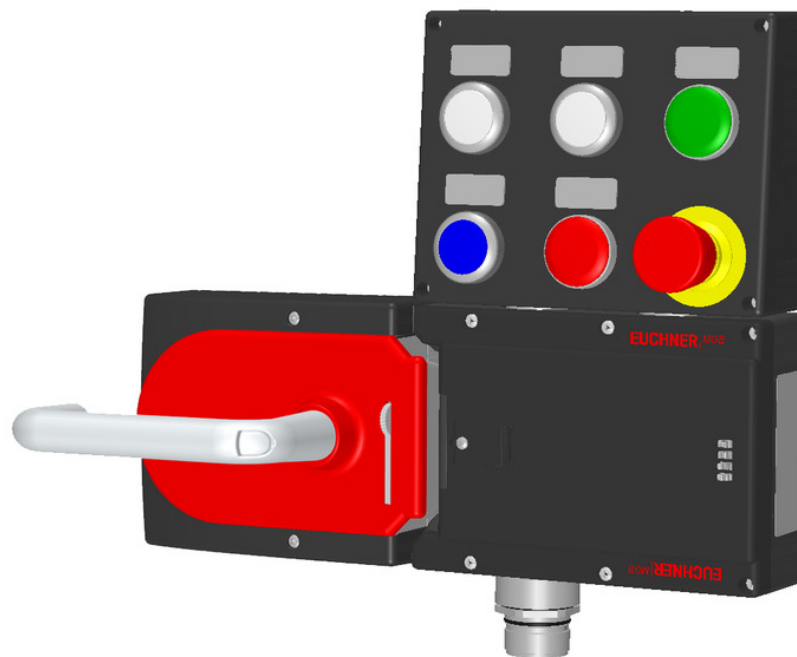

Features

- › Locking (without guard locking)
- › Can be connected in series with other AR devices (e.g. CES-AR and CET-AR)
- › With control module MGB-C
- › Emergency stop according to ISO 13850
- › 3 pushbuttons (illuminated, wh, wh, bu)
- › 2 indicators (illuminated, gn, rd)
- › Incl. adhesive labels
- › With plug connector RC26
- › Unicode

Guard locking type

MGB-LO... The bolt tongue in the handle module is moved into and out of the interlocking module by actuating the door handle. The door arm is not locked in the locked position.

Door hinge

A mechanical door stop is permanently integrated into the evaluation module of the MGB. A marking on the stop makes adjustment easier.

LED indicator

The LED indicator indicates all important system and status information.

Monitoring outputs

- OD** ON when the door is closed
 - OT** Bolt tongue inserted in the evaluation module
 - OI** Diagnostics; there is a fault
-

Emergency stop device

- S1** 2 positively driven NC contacts and 1 NO contact (e.g. monitoring contact), emergency stop with turn-to-reset, not illuminated
-

Pushbutton

- S10** 1 NO contact, white, illuminated
 - S11** 1 NO contact, white, illuminated
 - S15** 1 NO contact, blue, illuminated
-

Indicators

- H12** LED, green
 - H14** LED, red
-

Adhesive labels

Devices with adhesive labels have pre-formed recesses. The adhesive labels enclosed (standard size 12.5 x 27 mm) can be affixed in these recesses.

Components included in the set



- 110260 Interlocking module MGB-LOC-ARA-L-110260
 - Features
-



- 111158 Handle module MGB-H-AA1A3-L-111158
 - Features
-

Dimension drawing

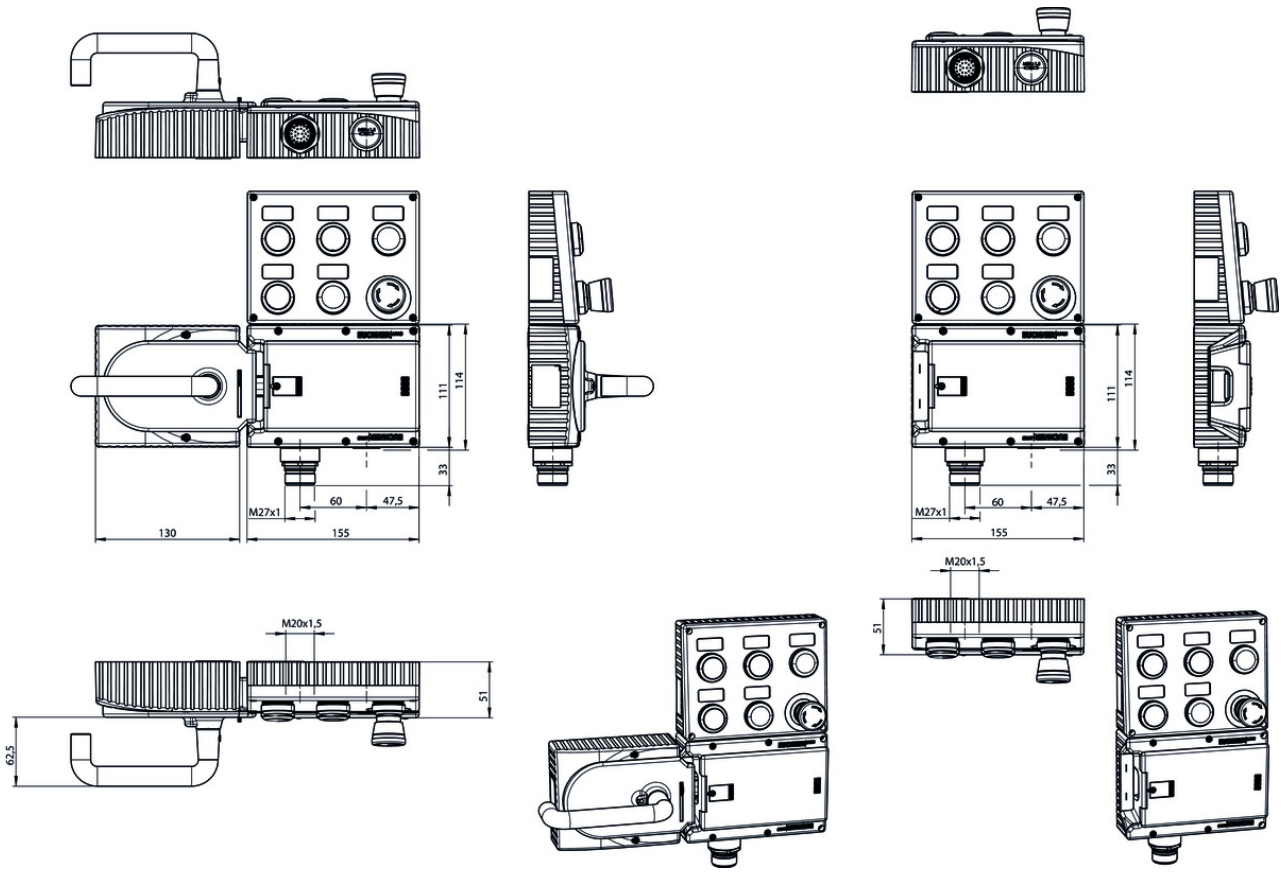

Dimension drawing

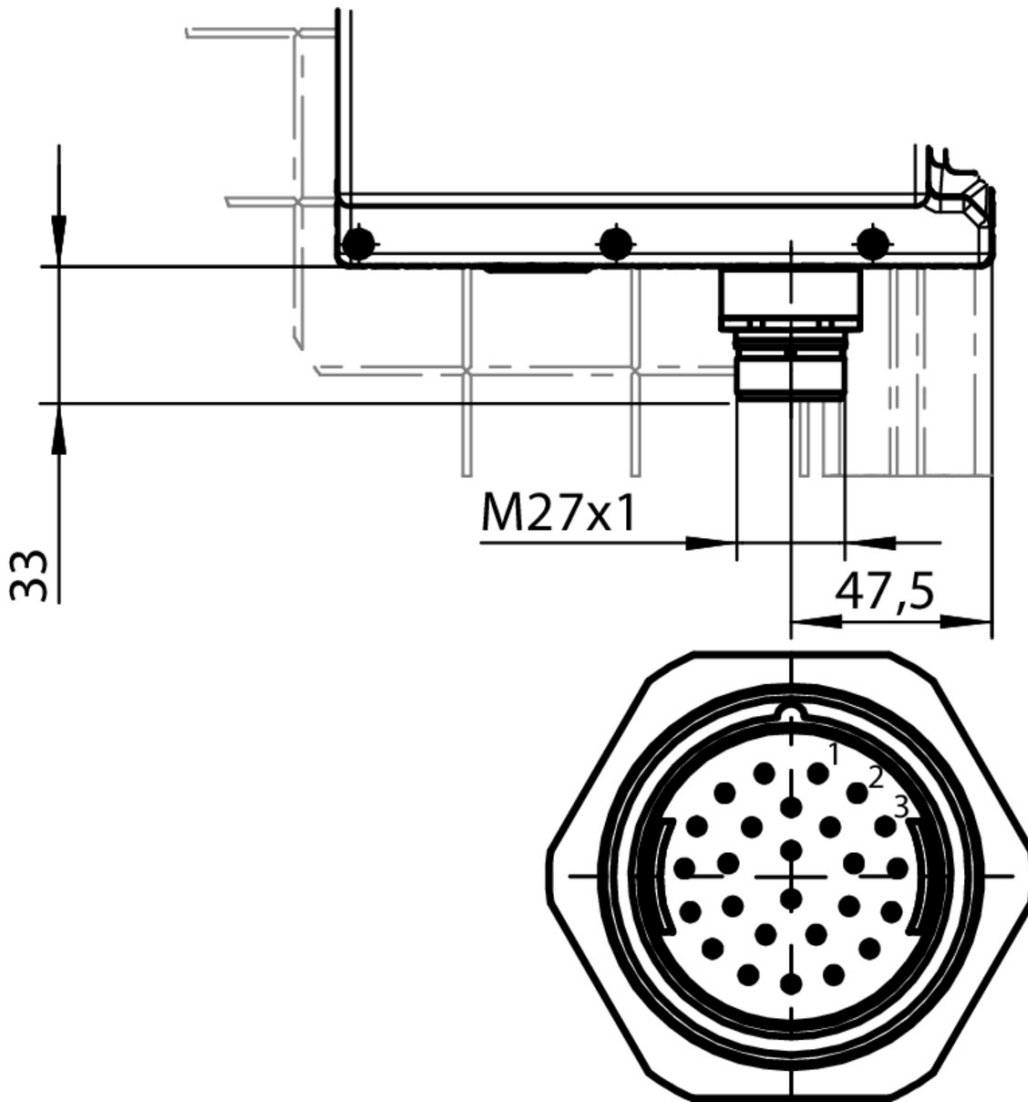

Plug connector RC26

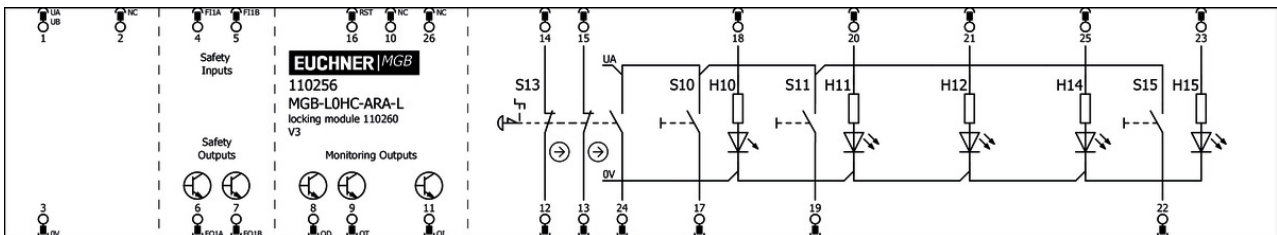

Mounting accessories

- ✓ Mounting plate for all MGB handle modules



109491 MGB-A-MOUNTINGPLATE-H-109491

✓ Features

- › Easy and quick mounting (only two screws required)
- › Quick module replacement
- › Steel, powder-coated
- › Suitable for doors hinged on the right or left

▼ Mounting plate for evaluation module-control module combination



110072 MGB-A-MOUNTINGPLATE-LC-110072

▼ Features

- › Easy and quick mounting (only two screws required)
 - › Quick module replacement
 - › Steel, powder-coated
 - › Suitable for doors hinged on the right or left
-

Connection material

▼ Connection cable with plug connector RC26, 26-pin, 1.1m



114976 C-M27F26-PU01,1-MA-114976

▼ Features

- › M27 female plug (RC26), 26-pin
 - › Straight plug connector
 - › TPE-U cable
 - › Cable length 1.1 m
 - › With flying lead
 - › Cores numbered, black
-

▼ Connection cable with plug connector RC26, 26-pin, 2m



111997 C-M27F26-PU02,0-MA-111997

▼ Features

- › M27 female plug (RC26), 26-pin
 - › Straight plug connector
 - › TPE-U cable
 - › Cable length 2 m
 - › With flying lead
 - › Cores numbered, black
-

▼ Connection cable with plug connector RC26, 26-pin, 5m



111998 C-M27F26-PU05,0-MA-111998

▼ Features

- › M27 female plug (RC26), 26-pin
 - › Straight plug connector
 - › TPE-U cable
 - › Cable length 5 m
 - › With flying lead
 - › Cores numbered, black
-

▼ Connection cable with plug connector RC26, 26-pin, 10m



111999 C-M27F26-PU10,0-MA-111999

▼ Features

- › M27 female plug (RC26), 26-pin
- › Straight plug connector

- › TPE-U cable
 - › Cable length 10 m
 - › With flying lead
 - › Cores numbered, black
-

- ▼ Connection cable with plug connector RC26, 26-pin, 20m



112912 C-M27F26-PU20,0-MA-112912

▼ Features

- › M27 female plug (RC26), 26-pin
 - › Straight plug connector
 - › TPE-U cable
 - › Cable length 20 m
 - › With flying lead
 - › Cores numbered, black
-

- ▼ Connection cable with plug connector RC26, 26-pin, 35m



123829 C-M27F26-PU35,0-MA-123829

▼ Features

- › M27 female plug (RC26), 26-pin
 - › Straight plug connector
 - › TPE-U cable
 - › Cable length 35 m
 - › With flying lead
 - › Cores numbered, black
-

- ▼ Connection cable with plug connector RC26, 26-pin, 50m



123877 C-M27F26-PU50,0-MA-123877

▼ Features

- › M27 female plug (RC26), 26-pin
 - › Straight plug connector
 - › TPE-U cable
 - › Cable length 50 m
 - › With flying lead
 - › Cores numbered, black
-

Miscellaneous accessories

- ▼ Lens set 6 colors



120378 AY-SET-LNS-0002-120378

- ▼ Lens set labeled



120377 AY-SET-LNS-SY01-120377

125359 AY-SET-LNS-SY02-125359



126158 AY-SET-LNS-SY03-126158

▼ Lens set 5 colors



120344 AY-SET-LNS-0001-120344

▼ Adhesive labels

114529 MGB-A-PLATESET-NN01-114529

▼ Features

- › Adhesive labels suitable for MGB evaluation modules, bus modules and control modules
- › silver, blank
- › Packaging unit = 10 pcs.

▼ Lens set, three colors



158307 AY-SET-LNS-SY04-158307

Spare parts

▼ Interlocking module MGB-L0H-ARA..., with 3 push buttons, 2 indicators, emergency stop, incl. label carrier, RC26



110260 MGB-L0C-ARA-L-110260

▼ Features

- › Locking (without guard locking)
- › Can be connected in series with other AR devices (e.g. CES-AR and CET-AR)
- › With control module MGB-C
- › Emergency stop according to ISO 13850
- › 3 pushbuttons (illuminated, wh, wh, bu)
- › 2 indicators (illuminated, gn, rd)
- › Incl. adhesive labels
- › With plug connector RC26
- › Unicode

▼ Handle module MGB-H... with automatically extending lockout mechanism



111158 MGB-H-AA1A3-L-111158

▼ Features

- › Intelligent bolt tongue
- › Fold-out lockout mechanism
- › Second automatically extending lockout mechanism
- › Door handle

Function expansion

Escape release MGB-E-A...



100465 MGB-E-A-100465

Features

- › Escape release from the danger zone
- › Door handle signal red
- › Extended actuation axis for thicker doors (available optionally)

Door knob for MGB-H...



111460 MGB-A-DOORKNOB-S1-111460

Features

- › Aluminum, silver anodized
- › For mounting on all MGB handle modules MGB-H... up to V2.0.0
- › e.g. on sliding doors



124030 MGB-A-DOORKNOB-S2-124030

Features

- › Aluminum, silver anodized
- › For mounting on all MGB handle modules MGB-H... from V3.0.0
- › e.g. on sliding doors

Door handle for MGB-H...



110277 MGB-A-DOORHANDLE-S1-110277

Features

- › Aluminum silver anodized
- › For mounting on all MGB handle modules MGB-H up to V2.0.0



123926 MGB-A-DOORHANDLE-S2-123926

Features

- › Aluminum silver anodized
- › For mounting on all MGB handle modules MGB-H from V3.0.0

Instructions

Návod k použití – bezpečnostní systémy MGB-L0...-AR.-... a MGB-L0...-AP.-... od V3.0.0

	Doc. no.	Version	Language	Download
Betriebsanleitung MGB-L0...AR.-... und MGB-L0...AP.-... ab V3.0.0	2112657	13-05/18		2.9 MB
Mode d'emploi MGB-L0...AR.-... et MGB-L0...AP.-... à partir de V3.0.0	2112657	13-05/18		3.0 MB

Manual de instrucciones MGB-L0...AR.-... y MGB-L0...AP.-... V3.0.0 o superior	2112657	13-05/18		2.9 MB
Návod k použití – bezpečnostní systémy MGB-L0...-AR.-... a MGB-L0...-AP.-... od V3.0.0	2112657	13-05/18		3.2 MB
Operating Instructions MGB-L0...AR.-... and MGB-L0...AP.-... from V3.0.0	2112657	13-05/18		2.9 MB
Istruzioni di impiego per MGB-L0...AR.-... e MGB-L0...AP.-... da V3.0.0	2112657	13-05/18		2.9 MB
Instrukcja obsługi MGB-L0...AR.-... i MGB-L0...AP.-... od V3.0.0	2112657	13-05/18		3.2 MB
Manual de instruções MGB-L0...AR.-... e MGB-L0...AP.-... a partir de V3.0.0	2112657	13-05/18		2.9 MB
Инструкция по эксплуатации MGB-L0...AR.-... и MGB-L0...AP.-... с V3.0.0	2112657	13-05/18		3.4 MB
Instruktionsbok MGB-L0...AR.-... och MGB-L0...AP.-... fr. V3.0.0	2112657	13-05/18		2.9 MB
操作指示書 安全システム MGB-L0...-AR.-... および MGB-L0...-AP.-... V3.0.0以降	2112657	13-05/18		3.3 MB
使用说明书 安全系统 MGB-L0...-AR.-...和MGB-L0...-AP.-... V3.0.0以上	2112657	13-05/18		3.3 MB













Sicherheitsinformation (Teil der Betriebsanleitung Sicherheitssystem MGB-AR/MGB-AP) ab V3.0.0

	Doc. no.	Version	Language	Download
Sicherheitsinformation (Teil der Betriebsanleitung Sicherheitssystem MGB-AR/MGB-AP) ab V3.0.0 Información de seguridad (parte del manual de instrucciones Sistema de seguridad MGB-AR/MGB-AP) V3.0.0 o superior Information de sécurité (partie du mode d'emploi Système de sécurité MGB-AR/MGB-AP) à partir de V3.0.0 Informazioni sulla sicurezza (Parte delle istruzioni di impiego Sistema di sicurezza MGB-AR/MGB-AP) da V3.0.0 Säkerhetsinformation (Del av instruktionsboken Säkerhetssystem MGB-AR/MGB-AP) från V3.0.0 Safety Information (Part of the Operating Instructions Safety System MGB-AR/MGB-AP) from V3.0.0	123151	01-02/15	 	0.6 MB
Veiligheidsinformatie (Deel van de handleiding Beveiligingssysteem MGB-AR/MGB-AP) vanaf V3.0.0	123151	01-02/15		0.2 MB
Informação de segurança (Parte do manual de instruções Sistema de segurança MGB-AR/MGB-AP) a partir de V3.0.0	123151	01-02/15		0.2 MB
Bezpečnostní informace (součást návodu k použití „Bezpečnostní systém MGB-AR/MGB-AP“) od V3.0.0	123151	01-02/15		0.2 MB

Informacje o bezpieczeństwie (Część instrukcji obsługi System bezpieczeństwa MGB-AR/MGB-AP) od V3.0.0	123151	01-02/15		 0.2 MB
Информация о безопасности (часть инструкции по эксплуатации Предохранительная система MGB-AR/MGB-AP) с V3.0.0	123151	01-02/15		 0.3 MB
Bezpečnostná informácia (časť návodu na prevádzku Bezpečnostný systém MGB-AR/MGB-AP) od V3.0.0	123151	01-02/15		 0.2 MB
Güvenlik bilgisi (İşletim kılavuzunun parçası emniyet sistemi MGB-AR/MGB-AP) V3.0.0 ve üstü	123151	01-02/15		 0.3 MB
安全信息 (安全系统 MGB-AR/MGB-AP使用说明书的组成部分) V3.0.0以上	123151	01-02/15		 0.3 MB
安全情報 MGB-AR/MGB-AP	123151	01-02/15		 0.6 MB







Catalogs

 Multifunctional Gate Box MGB Multifunctional Gate Box MGB Multifunctional Gate Box MGB Multifunctional Gate Box MGB Multifunctional Gate Box MGB Multifunctional Gate Box MGB Multifunctional Gate Box MGB 多功能系统安全控制系统 MGB

	Doc. no.	Version	Language	Download
Multifunctional Gate Box MGB	106108	10-02/18		 8.2 MB
Multifunctional Gate Box MGB	109155	10-02/18		 8.2 MB
Multifunctional Gate Box MGB	114433	10-02/18		 8.3 MB
Multifunctional Gate Box MGB	121652	10-02/18		 8.0 MB
Multifunctional Gate Box MGB	106109	10-02/18		 8.2 MB
多功能系统安全控制系统 MGB	155883	10-02/18		 8.3 MB

Declaration of conformity

 EU-Konformitätserklärung

	Doc. no.	Version	Language	Download
EU-Konformitätserklärung Declaración UE de conformidad Déclaration UE de conformité Dichiarazione di conformità EU declaration of conformity	2123150	08-01/17	    	 0.3 MB