

ITEM 110260 MGB-LOC-ARA-L-110260

Description	Technical data	Accessories	Downloads
-------------	----------------	-------------	-----------

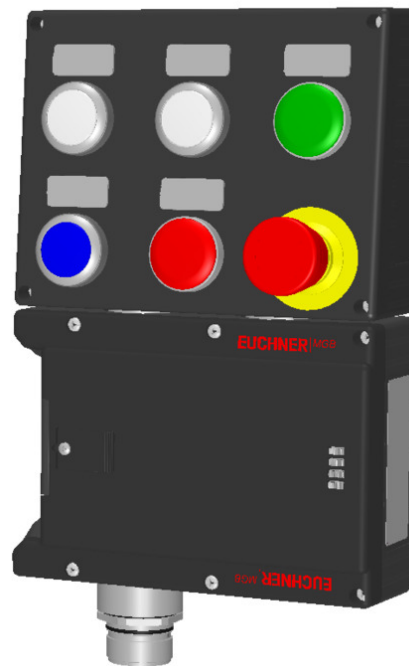

Features

- › Locking (without guard locking)
- › Can be connected in series with other AR devices (e.g. CES-AR and CET-AR)
- › With control module MGB-C
- › Emergency stop according to ISO 13850
- › 3 pushbuttons (illuminated, wh, wh, bu)
- › 2 indicators (illuminated, gn, rd)
- › Incl. adhesive labels
- › With plug connector RC26
- › Unicode

Guard locking type

MGB- The bolt tongue in the handle module is moved into and out of the **L0...** interlocking module by actuating the door handle. The door arm is not locked in the locked position.

Door hinge

A mechanical door stop is permanently integrated into the evaluation module of the MGB. A marking on the stop makes adjustment easier.

LED indicator

The LED indicator indicates all important system and status information.

Monitoring outputs

- OD** ON when the door is closed
 - OT** Bolt tongue inserted in the evaluation module
 - OI** Diagnostics; there is a fault
-

Emergency stop device

- S1** 2 positively driven NC contacts and 1 NO contact (e.g. monitoring contact), emergency stop with turn-to-reset, not illuminated
-

Pushbutton

- S10** 1 NO contact, white, illuminated
 - S11** 1 NO contact, white, illuminated
 - S15** 1 NO contact, blue, illuminated
-

Indicators

- H12** LED, green
 - H14** LED, red
-

Adhesive labels

Devices with adhesive labels have pre-formed recesses. The adhesive labels enclosed (standard size 12.5 x 27 mm) can be affixed in these recesses.

Approvals



Mechanical values and environment

Housing material	Reinforced plastic; die-cast zinc nickel-plated, stainless steel
Weight	Net 1,4 kg
Ambient temperature	
At $U_B = 24V$ DC	-20 ... 55 °C
Degree of protection	IP65
Mechanical life	
In case of use as door stop, and 1 Joule impact energy	1×10^6 $0,1 \times 10^6$

Installation position	Door hinge DIN left
Switching frequency	0,25 Hz
Connection	Plug connector RC26 ^[1]

Electrical connection ratings

Utilization category according to EN 60947-5-2	DC-13	24V 200mA ^[2]
Rated insulation voltage U_i		30 V
Rated impulse withstand voltage U_{imp}		1,5 kV
Degree of contamination (external, according to EN 60947-1)		3
Safety class		III
Discrepancy time		
Between FO1A and FO1B		max.10 ms
Risk time according to EN 60947-5-3		max.350 ms
Transponder coding		Unicode
Power supply U_B		
Operating voltage DC	U_B	24 V DC -15% ... 10% ^[3]
Current consumption	I_{UB}	max.80 mA ^[4]
Power supply U_A		
Operating voltage DC	U_A	24 V DC -15% ... 10% ^[5]
Current consumption	I_{UA}	max.10 mA ^[6]
Safety outputs FO1A, FO1B		
Test pulses		max.1 ms
Test-pulse interval		min.100 ms
Type of output		Semiconductor outputs, p-switching, short circuit-proof
Output voltage		
U_{FO1A} / U_{FO1B} LOW		0 ... 1 V DC
U_{FO1A} / U_{FO1B} HIGH		$U_B - 2V \dots U_B$ V DC ^[7]
Output current		
Per safety output FO1A / FO1B		1 ... 200 mA
Monitoring outputs OD, OT, OL, OI		
Type of output		Semiconductor outputs, p-switching, short circuit-proof
Output voltage		$U_A - 2V \dots U_A$ V DC ^[8]
Output current		max.50 mA
Controls and indicators		
Switching voltage		U_A V
Switching current		1 ... 10 mA
Breaking capacity		max.0,25 W
Power supply LED		24 V DC

	Emergency stop
Switching voltage	5 ... 24 V
Switching current	1 ... 100 mA
Breaking capacity	max.0,25 W
Power supply LED	24 V DC

Controls and indicators

Assignment diagram	C2
Assignment diagram	L0
Control/indicator	
	Position 10
Version	Illuminated push buttons
Special features	
Color	white
Switching element	1NO
Slide-in label	
Control/indicator	
	Position 11
Version	Illuminated push buttons
Special features	
Color	white
Switching element	1NO
Slide-in label	
Control/indicator	
	Position 12
Version	Cover for indicators
Special features	
Color	Green
Switching element	
Slide-in label	
Control/indicator	
	Position 13
Version	Emergency stop
Special features	With auxiliary contact
Color	
Switching element	2 pos. driven NC + 1NO
Slide-in label	Adhesive label D40mm
Control/indicator	
	Position 14
Version	Cover for indicators
Special features	
Color	Red
Switching element	

Slide-in label	
Control/indicator	
	Position 15
Version	Illuminated push buttons
Special features	
Color	Blue
Switching element	1NO
Slide-in label	

Miscellaneous

Product version number	V3.0.0
Slide-in label	5 pc. without marking

Reliability values acc. to EN ISO 13849-1

	Monitoring of the position of the safety guard
Category	4
Performance Level	PL e
PFH _D	3.7×10^{-9}
	Emergency stop
B10 _D	Emergency stop $0,065 \times 10^6$

Mission time	20 y
--------------	------

[1] X6

[2] Caution: outputs must be protected with a free-wheeling diode in case of inductive loads.

[3, 5] (Reverse polarity protected, regulated, residual ripple <5%, PELV)

[4] (no load on outputs)

[6] (With no load on outputs OD, OT, OL, OI)

[7, 8] Value at a switching current of 50mA without taking into account the cable lengths

Dimension drawing

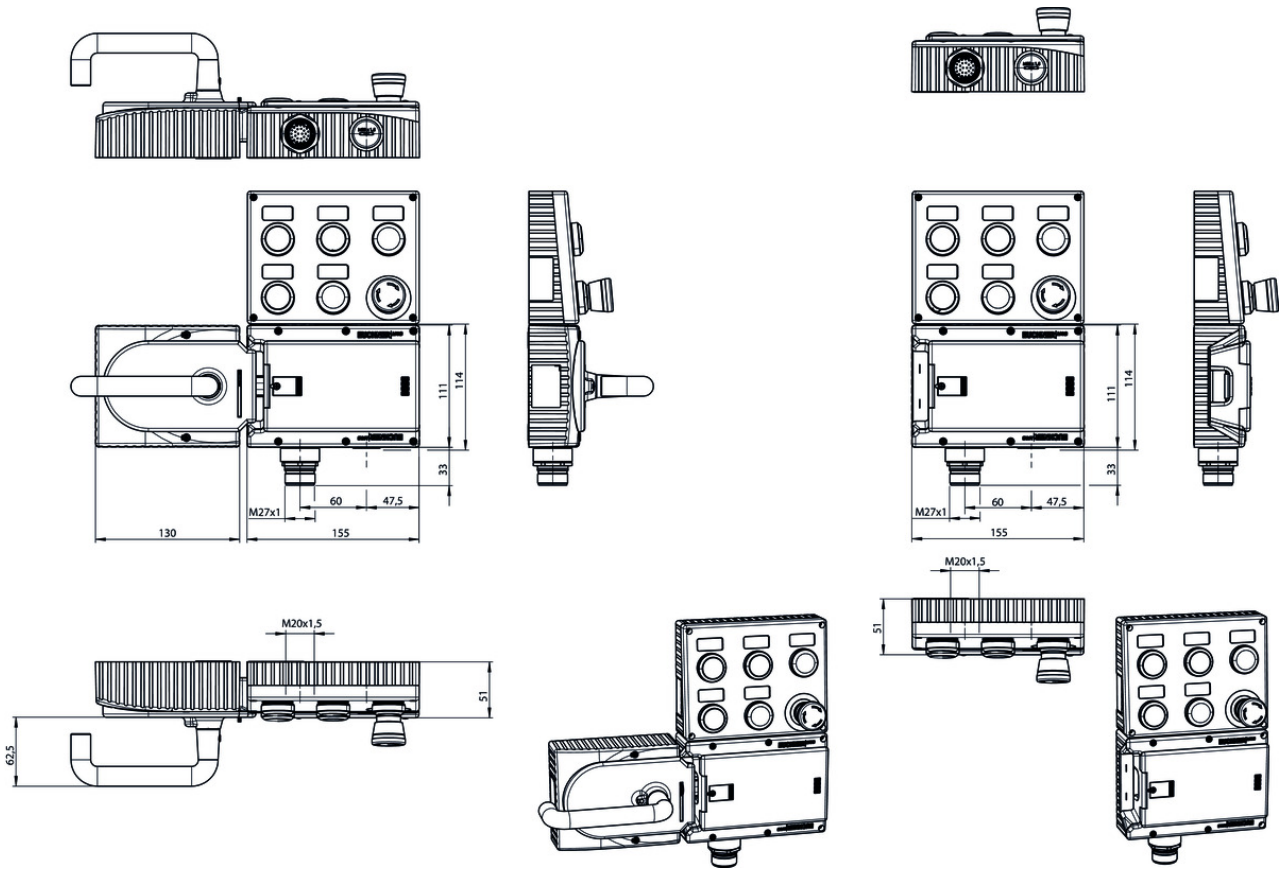

Dimension drawing

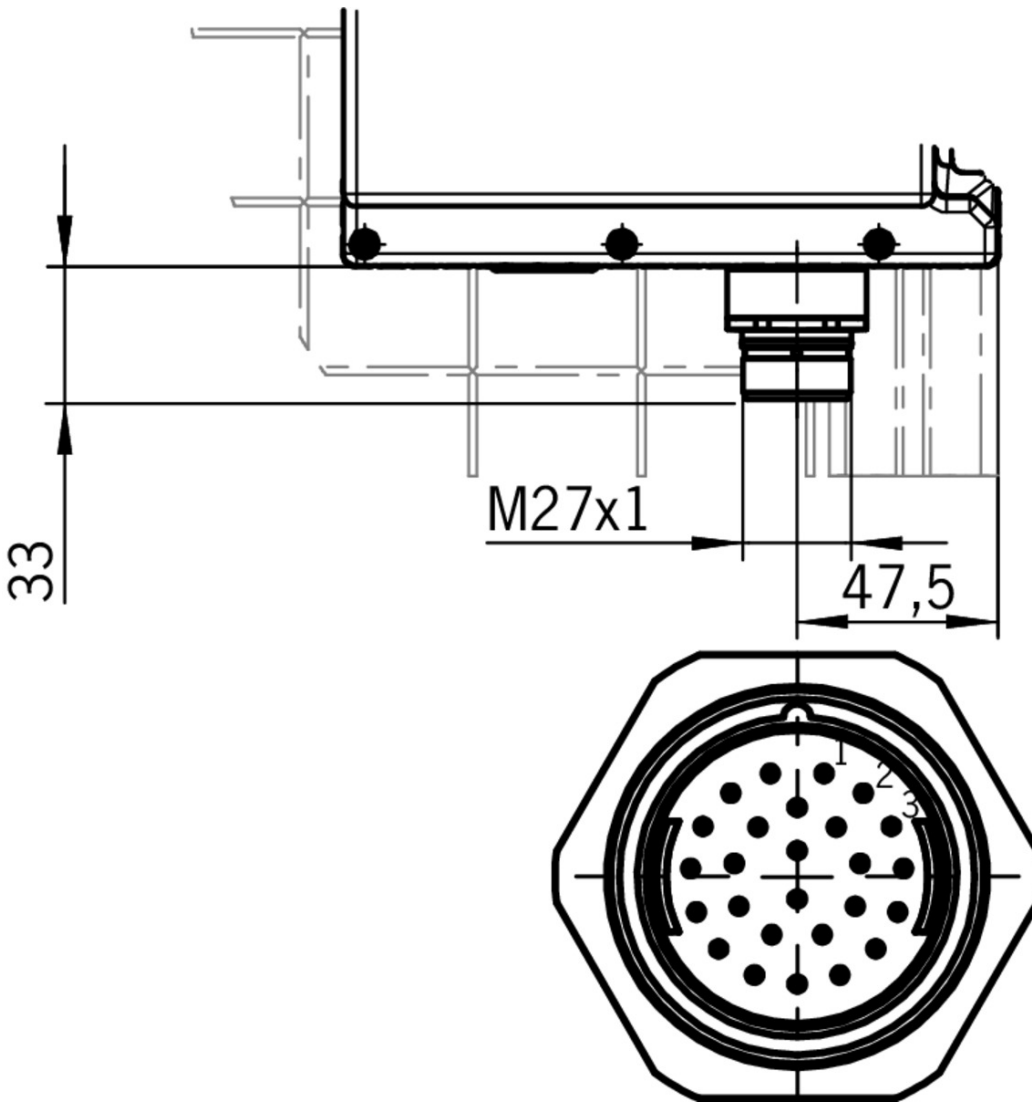

Plug connector RC26

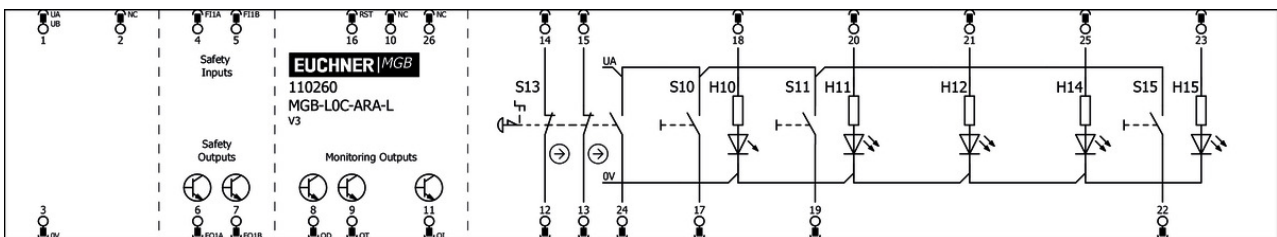

Mounting accessories

- ✓ Mounting plate for evaluation module-control module combination



110072 MGB-A-MOUNTINGPLATE-LC-110072

✓ Features

- › Easy and quick mounting (only two screws required)
- › Quick module replacement
- › Steel, powder-coated
- › Suitable for doors hinged on the right or left

Miscellaneous accessories

▼ Lens set 5 colors



120344 AY-SET-LNS-0001-120344

▼ Lens set labeled



120377 AY-SET-LNS-SY01-120377



125359 AY-SET-LNS-SY02-125359



126158 AY-SET-LNS-SY03-126158

▼ Lens set 6 colors



120378 AY-SET-LNS-0002-120378

▼ Adhesive labels

114529 MGB-A-PLATESET-NN01-114529

▼ Features

- › Adhesive labels suitable for MGB evaluation modules, bus modules and control modules
 - › silver, blank
 - › Packaging unit = 10 pcs.
-

▼ Lens set, three colors



158307 AY-SET-LNS-SY04-158307

Connection material

▼ Connection cable with plug connector RC26, 26-pin, 1.1m



114976 C-M27F26-PU01,1-MA-114976

▼ Features

- › M27 female plug (RC26), 26-pin
- › Straight plug connector
- › TPE-U cable
- › Cable length 1.1 m
- › With flying lead

- › Cores numbered, black
-

- ▼ Connection cable with plug connector RC26, 26-pin, 2m



111997 C-M27F26-PU02,0-MA-111997

▼ Features

- › M27 female plug (RC26), 26-pin
 - › Straight plug connector
 - › TPE-U cable
 - › Cable length 2 m
 - › With flying lead
 - › Cores numbered, black
-

- ▼ Connection cable with plug connector RC26, 26-pin, 5m



111998 C-M27F26-PU05,0-MA-111998

▼ Features

- › M27 female plug (RC26), 26-pin
 - › Straight plug connector
 - › TPE-U cable
 - › Cable length 5 m
 - › With flying lead
 - › Cores numbered, black
-

- ▼ Connection cable with plug connector RC26, 26-pin, 10m



111999 C-M27F26-PU10,0-MA-111999

▼ Features

- › M27 female plug (RC26), 26-pin
 - › Straight plug connector
 - › TPE-U cable
 - › Cable length 10 m
 - › With flying lead
 - › Cores numbered, black
-

- ▼ Connection cable with plug connector RC26, 26-pin, 20m



112912 C-M27F26-PU20,0-MA-112912

▼ Features

- › M27 female plug (RC26), 26-pin
 - › Straight plug connector
 - › TPE-U cable
 - › Cable length 20 m
 - › With flying lead
 - › Cores numbered, black
-

- ▼ Connection cable with plug connector RC26, 26-pin, 35m



123829 C-M27F26-PU35,0-MA-123829

▼ Features

- › M27 female plug (RC26), 26-pin
- › Straight plug connector

- › TPE-U cable
- › Cable length 35 m
- › With flying lead
- › Cores numbered, black

☑ Connection cable with plug connector RC26, 26-pin, 50m



123877 C-M27F26-PU50,0-MA-123877

☑ Features

























- › M27 female plug (RC26), 26-pin
- › Straight plug connector
- › TPE-U cable
- › Cable length 50 m
- › With flying lead
- › Cores numbered, black

Instructions

☑ Návod k použití – bezpečnostní systémy MGB-L0...-AR... a MGB-L0...-AP... od V3.0.0







	Doc. no.	Version	Language	Download
Betriebsanleitung MGB-L0...AR... und MGB-L0...AP... ab V3.0.0	2112657	13-05/18		2.9 MB
Mode d'emploi MGB-L0...AR... et MGB-L0...AP... à partir de V3.0.0	2112657	13-05/18		3.0 MB
Manual de instrucciones MGB-L0...AR... y MGB-L0...AP... V3.0.0 o superior	2112657	13-05/18		2.9 MB
Návod k použití – bezpečnostní systémy MGB-L0...-AR... a MGB-L0...-AP... od V3.0.0	2112657	13-05/18		3.2 MB
Operating Instructions MGB-L0...AR... and MGB-L0...AP... from V3.0.0	2112657	13-05/18		2.9 MB
Istruzioni di impiego per MGB-L0...AR... e MGB-L0...AP... da V3.0.0	2112657	13-05/18		2.9 MB
Instrukcja obsługi MGB-L0...AR... i MGB-L0...AP... od V3.0.0	2112657	13-05/18		3.2 MB
Manual de instruções MGB-L0...AR... e MGB-L0...AP... a partir de V3.0.0	2112657	13-05/18		2.9 MB
Инструкция по эксплуатации MGB-L0...AR... и MGB-L0...AP... с V3.0.0	2112657	13-05/18		3.4 MB
Instruktionsbok MGB-L0...AR... och MGB-L0...AP... fr. V3.0.0	2112657	13-05/18		2.9 MB
操作指示書 安全システム MGB-L0...-AR... および MGB-L0...-AP... V3.0.0以降	2112657	13-05/18		3.3 MB
使用说明书 安全系统 MGB-L0...-AR...和MGB-L0...-AP... V3.0.0以上	2112657	13-05/18		3.3 MB

☑ Sicherheitsinformation (Teil der Betriebsanleitung Sicherheitssystem MGB-AR/MGB-AP) ab V3.0.0

	Doc. no.	Version	Language	Download
Sicherheitsinformation (Teil der Betriebsanleitung Sicherheitssystem MGB-AR/MGB-AP) ab V3.0.0 Información de seguridad (parte del manual de instrucciones Sistema de seguridad MGB-AR/MGB-AP) V3.0.0 o superior Information de sécurité (partie du mode d'emploi Système de sécurité MGB-AR/MGB-AP) à partir de V3.0.0 Informazioni sulla sicurezza (Parte delle istruzioni di impiego Sistema di sicurezza MGB-AR/MGB-AP) da V3.0.0 Säkerhetsinformation (Del av instruktionsboken Säkerhetssystem MGB-AR/MGB-AP) från V3.0.0 Safety Information (Part of the Operating Instructions Safety System MGB-AR/MGB-AP) from V3.0.0	123151	01-02/15	     	 0.6 MB
Veiligheidsinformatie (Deel van de handleiding Beveiligingssysteem MGB-AR/MGB-AP) vanaf V3.0.0	123151	01-02/15		 0.2 MB
Informação de segurança (Parte do manual de instruções Sistema de segurança MGB-AR/MGB-AP) a partir de V3.0.0	123151	01-02/15		 0.2 MB
Bezpečnostní informace (součást návodu k použití „Bezpečnostní systém MGB-AR/MGB-AP“) od V3.0.0	123151	01-02/15		 0.2 MB
Informacje o bezpieczeństwie (Część instrukcji obsługi System bezpieczeństwa MGB-AR/MGB-AP) od V3.0.0	123151	01-02/15		 0.2 MB
Информация о безопасности (часть инструкции по эксплуатации Предохранительная система MGB-AR/MGB-AP) с V3.0.0	123151	01-02/15		 0.3 MB
Bezpečnostná informácia (časť návodu na prevádzku Bezpečnostný systém MGB-AR/MGB-AP) od V3.0.0	123151	01-02/15		 0.2 MB
Güvenlik bilgisi (İşletim kılavuzunun parçası emniyet sistemi MGB-AR/MGB-AP) V3.0.0 ve üstü	123151	01-02/15		 0.3 MB
安全信息 (安全系统 MGB-AR/MGB-AP使用说明书的组成部分) V3.0.0以上	123151	01-02/15		 0.3 MB
安全情報 MGB-AR/MGB-AP	123151	01-02/15		 0.6 MB

Declaration of conformity

 EU-Konformitätserklärung

	Doc. no.	Version	Language	Download
EU-Konformitätserklärung Declaración UE de conformidad Déclaration UE de conformité Dichiarazione di conformità EU declaration of conformity	2123150	08-01/17	    	 0.3 MB

