

## ITEM 110871 MGB-L1H-ARA-L-110871

Description	Technical data	Accessories	Downloads
-------------	----------------	-------------	-----------

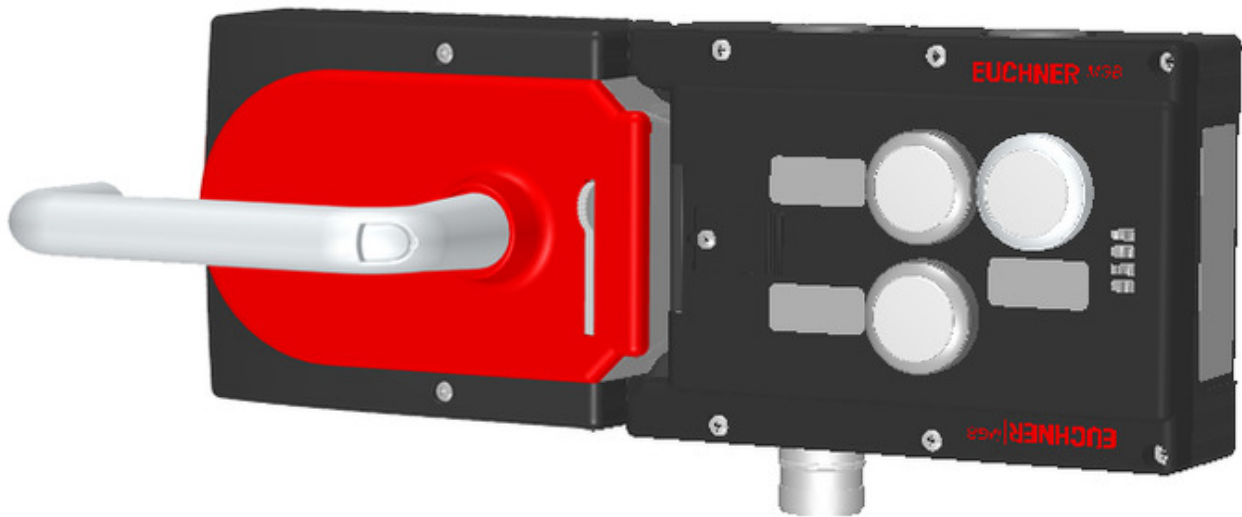

### Features

- › Guard locking with guard lock monitoring
- › Can be connected in series with other AR devices (e.g. CES-AR and CET-AR)
- › 3 pushbuttons (illuminated, wh, wh, wh)
- › Incl. adhesive labels
- › With plug connector RC18
- › Unicode

### Guard locking type

**MGB-** The locking arm is held in the locked position by spring force and is  
**L1...** unlocked by solenoid force (closed-circuit current principle, mechanically locked).

### Door hinge

A mechanical door stop is permanently integrated into the evaluation module of the MGB. A marking on the stop makes adjustment easier.

### LED indicator

The LED indicator indicates all important system and status information.

## Monitoring outputs

- OD** ON when the door is closed
  - OT** Bolt tongue inserted in the evaluation module
  - OL** Guard locking solenoid in locked position
  - OI** Diagnostics; there is a fault
- 

## Pushbutton

- S1** 1 NO contact, white, illuminated
  - S2** 1 NO contact, white, illuminated
  - S3** 1 NO contact, white, illuminated
- 

## Adhesive labels

Devices with adhesive labels have pre-formed recesses. The adhesive labels enclosed (standard size 12.5 x 27 mm) can be affixed in these recesses.

## Components included in the set

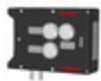

110873 Locking module MGB-L1-ARA-AD4A1-S1-L-110873  
 Features

---



106619 Handle module MGB-H-AA1A1-L-106619  
 Features

---

# Dimension drawing

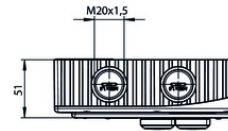
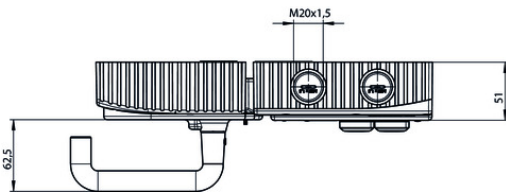
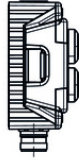
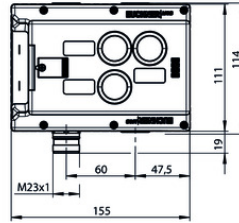
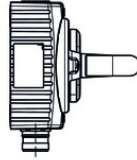
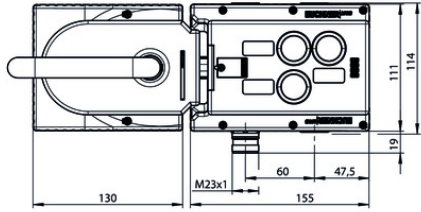
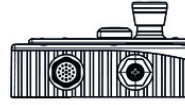
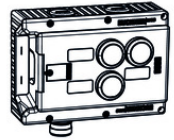
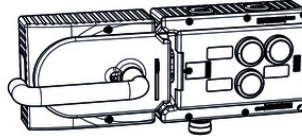
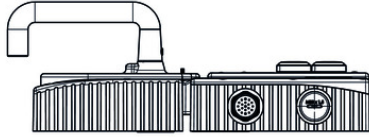

## Dimension drawing

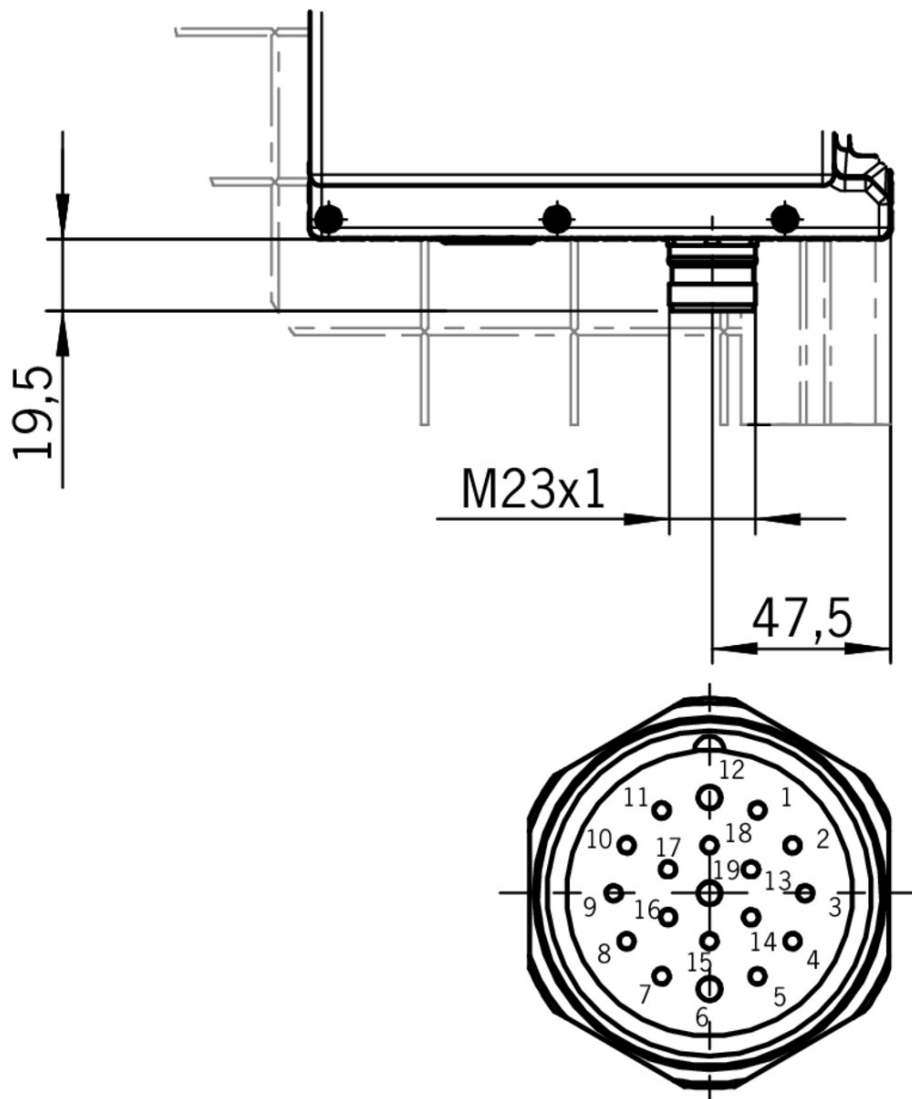

## Plug connector RC18

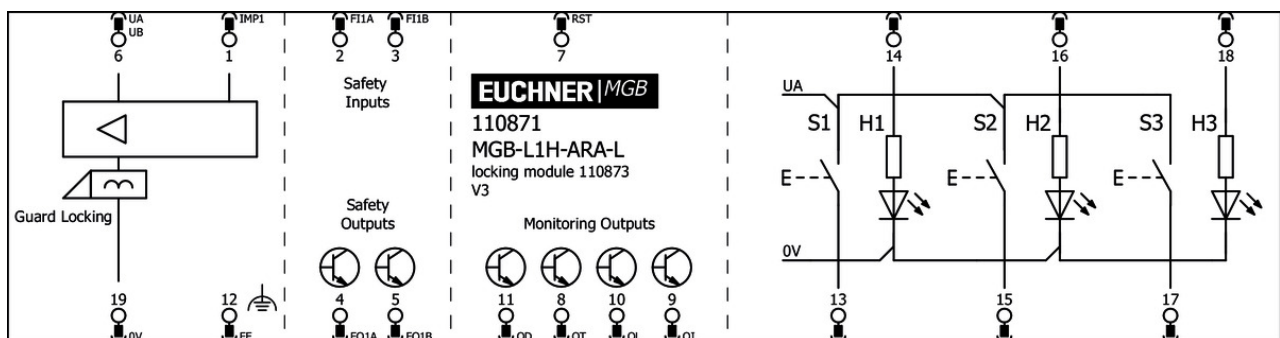

## Function expansion

- ✓ Door handle for MGB-H...



**110277** MGB-A-DOORHANDLE-S1-110277

- ✓ Features

- › Aluminum silver anodized

- › For mounting on all MGB handle modules MGB-H up to V2.0.0



**123926** MGB-A-DOORHANDLE-S2-123926

✓ Features

- › Aluminum silver anodized
- › For mounting on all MGB handle modules MGB-H from V3.0.0

✓ Emergency unlocking for safety system MGB



**112989** MGB-A-EMERGENCYRELEASE-112989

✓ Features

- › Quick emergency unlocking
- › sealable

✓ Door knob for MGB-H...



**111460** MGB-A-DOORKNOB-S1-111460

✓ Features

- › Aluminum, silver anodized
- › For mounting on all MGB handle modules MGB-H... up to V2.0.0
- › e.g. on sliding doors



**124030** MGB-A-DOORKNOB-S2-124030

✓ Features

- › Aluminum, silver anodized
- › For mounting on all MGB handle modules MGB-H... from V3.0.0
- › e.g. on sliding doors

✓ Escape release MGB-E-A...



**100465** MGB-E-A-100465

✓ Features

- › Escape release from the danger zone
- › Door handle signal red
- › Extended actuation axis for thicker doors (available optionally)

## Mounting accessories

✓ Mounting plate for all MGB handle modules



**109491** MGB-A-MOUNTINGPLATE-H-109491

✓ Features

- › Easy and quick mounting (only two screws required)
- › Quick module replacement
- › Steel, powder-coated
- › Suitable for doors hinged on the right or left

✓ Mounting plate for evaluation modules MGB-L.-AR.-... and MGB-L.-AP.-...



### **109490** MGB-A-MOUNTINGPLATE-L-109490

#### ▼ Features

- › Easy and quick mounting (only two screws required)
  - › Quick module replacement
  - › Steel, powder-coated
  - › Suitable for doors hinged on the right or left
- 

## Spare parts

---

- ▼ Locking module MGB-L1-ARA..., (guard locking by spring force) with 3 push buttons, incl. label carrier, RC18

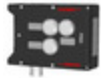

### **110873** MGB-L1-ARA-AD4A1-S1-L-110873

#### ▼ Features

- › Guard locking with guard lock monitoring
  - › Can be connected in series with other AR devices (CES-AR and CET-AR)
  - › 3 pushbuttons (illuminated, wh, wh, wh)
  - › Incl. adhesive labels
  - › With plug connector RC18
  - › Unicode
- 

- ▼ Handle module MGB-H...



### **106619** MGB-H-AA1A1-L-106619

#### ▼ Features

- › Intelligent bolt tongue
  - › Lockout bar
  - › Door handle
- 

## Connection material

---

- ▼ Female plug RC18 straight with option C1825



### **077025** RC18EF-C1825

#### ▼ Features

- › Plug connector M23, straight
  - › Number of pins: 19-pin with screen bonding clamp
- 

- ▼ Connection cable with plug connector M23, 19-pin, 25m, straight



### **110307** C-M23F19-19XDIFPU25,0-MA-110307

#### ▼ Features

- › M23 female plug, 19-pin
  - › Straight plug connector
  - › PUR cable
  - › Cable length 25 m
  - › With flying lead
  - › Cores numbered, black
-

- ▼ Replacement crimp contacts for female connector RC18 with option C1825

**094310** CRIMPKONTAKT BUCHSE RCF-C1825

▼ Features

- › 19 crimp sockets
  - › Conductor cross-section 16 x 0.25 - 0.5 mm<sup>2</sup> and 3 x 0.75 - 1 mm<sup>2</sup>
  - › For plug connector RC18..C1825
- 

- ▼ Connection cable with plug connector M23 with option C1825, 1.5m, straight



**092761** C-M23F19-19XDIFPU01,5-MA-092761

▼ Features

- › M23 plug connector, 18-pin + PE
  - › Straight plug connector
  - › PUR cable
  - › Cable length 1.5 m
  - › With flying lead
  - › Cores color-coded
- 

- ▼ Connection cable with plug connector M23 with option C1825, 3m, straight



**092816** C-M23F19-19XDIFPU03,0-MA-092816

▼ Features

- › M23 plug connector, 18-pin + PE
  - › Straight plug connector
  - › PUR cable
  - › Cable length 3 m
  - › With flying lead
  - › Cores color-coded
- 

- ▼ Connection cable with plug connector M23 with option C1825, 6m, straight



**077014** C-M23F19-19XDIFPU06,0-MA-077014

▼ Features

- › M23 plug connector, 18-pin + PE
  - › Straight plug connector
  - › PUR cable
  - › Cable length 6 m
  - › With flying lead
  - › Cores color-coded
- 

- ▼ Connection cable with plug connector M23 with option C1825, 8m, straight



**077015** C-M23F19-19XDIFPU08,0-MA-077015

▼ Features

- › M23 plug connector, 18-pin + PE
  - › Straight plug connector
  - › PUR cable
  - › Cable length 8 m
  - › With flying lead
  - › Cores color-coded
-

- ▼ Connection cable with plug connector M23 with option C1825, 10m, straight



**092898** C-M23F19-19XDIFPU10,0-MA-092898

▼ Features

- › M23 plug connector, 18-pin + PE
  - › Straight plug connector
  - › PUR cable
  - › Cable length 10 m
  - › With flying lead
  - › Cores color-coded
- 

- ▼ Connection cable with plug connector M23 with option C1825, 20m, straight



**092726** C-M23F19-19XDIFPU20,0-MA-092726

▼ Features

- › M23 plug connector, 18-pin + PE
  - › Straight plug connector
  - › PUR cable
  - › Cable length 20 m
  - › With flying lead
  - › Cores color-coded
- 

- ▼ Connection cable with plug connector M23 with option C1825, 15m, straight



**077016** C-M23F19-19XDIFPU15,0-MA-077016

▼ Features

- › M23 plug connector, 18-pin + PE
  - › Straight plug connector
  - › PUR cable
  - › Cable length 15 m
  - › With flying lead
  - › Cores color-coded
- 

- ▼ Connection cable with plug connector M23 with option C1825, 25m, straight



**092727** C-M23F19-19XDIFPU25,0-MA-092727

▼ Features

- › M23 plug connector, 18-pin + PE
  - › Straight plug connector
  - › PUR cable
  - › Cable length 25 m
  - › With flying lead
  - › Cores color-coded
- 

- ▼ Connection cable with plug connector M23 with option C1825, 30m, straight



**095993** C-M23F19-19XDIFPU30,0-MA-095993

▼ Features

- › M23 plug connector, 18-pin + PE
- › Straight plug connector
- › PUR cable
- › Cable length 30 m
- › With flying lead



› Cores color-coded

---

▼ Connection cable with plug connector M23 with option C1825, 40m, straight



**102490** C-M23F19-19XDIFPU40,0-MA-102490

▼ Features

- › M23 plug connector, 18-pin + PE
  - › Straight plug connector
  - › PUR cable
  - › Cable length 40 m
  - › With flying lead
  - › Cores color-coded
- 

## Miscellaneous accessories

---

▼ Lens set 5 colors



**120344** AY-SET-LNS-0001-120344

---

▼ Lens set 6 colors



**120378** AY-SET-LNS-0002-120378

---

▼ Lens set labeled



**120377** AY-SET-LNS-SY01-120377

---



**125359** AY-SET-LNS-SY02-125359

---



**126158** AY-SET-LNS-SY03-126158

---

▼ Adhesive labels

**114529** MGB-A-PLATESET-NN01-114529

▼ Features

- › Adhesive labels suitable for MGB evaluation modules, bus modules and control modules
  - › silver, blank
  - › Packaging unit = 10 pcs.
- 

▼ Lens set, three colors



























**158307** AY-SET-LNS-SY04-158307

## Instructions

- ▼ Návod k použití – bezpečnostní systémy MGB-L1...AR.-... / MGB-L2...AR.-... a MGB-L1...AP.-... / MGB-L2...AP.-... od V3.0.0

	Doc. no.	Version	Language	Download
Betriebsanleitung MGB-L1...AR.-... / MGB-L2...AR.-... und MGB-L1...AP.-... / MGB-L2...AP.-... ab V3.0.0	2119167	04-05/18		 3.7 MB
Mode d'emploi MGB-L1...AR.-... / MGB-L2...AR.-... et MGB-L1...AP.-... / MGB-L2...AP.-... à partir de V3.0.0	2119167	04-05/18		 3.7 MB
Manual de instrucciones MGB-L1...AR.-... / MGB-L2...AR.-... y MGB-L1...AP.-... / MGB-L2...AP.-... V3.0.0 o superior	2119167	04-05/18		 3.7 MB
Návod k použití – bezpečnostní systémy MGB-L1...AR.-... / MGB-L2...AR.-... a MGB-L1...AP.-... / MGB-L2...AP.-... od V3.0.0	2119167	04-05/18		 4.0 MB
Operating Instructions MGB-L1...AR.-... / MGB-L2...AR.-... and MGB-L1...AP.-... / MGB-L2...AP.-... from V3.0.0	2119167	04-05/18		 3.7 MB
Istruzioni di impiego MGB-L1...AR.-... / MGB-L2...AR.-... und MGB-L1...AP.-... / MGB-L2...AP.-... da V3.0.0	2119167	04-05/18		 3.7 MB
Handleiding MGB-L1...AR.-... / MGB-L2...AR.-... en MGB-L1...AP.-... / MGB-L2...AP.-... vanaf V3.0.0	2119167	04-05/18		 3.7 MB
Instrukcja obsługi MGB-L1...AR.-... / MGB-L2...AR.-... i MGB-L1...AP.-... / MGB-L2...AP.-... od V3.0.0	2119167	04-05/18		 4.0 MB
Manual de instruções MGB-L1...AR.-... / MGB-L2...AR.-... e MGB-L1...AP.-... / MGB-L2...AP.-... a partir de V3.0.0	2119167	04-05/18		 3.7 MB
Инструкция по эксплуатации MGB-L1...AR.-... / MGB-L2...AR.-... и MGB-L1...AP.-... / MGB-L2...AP.-... с V3.0.0	2119167	04-05/18		 4.2 MB
Návod na prevádzku Bezpečnostné systémy MGB-L1...AR.-... / MGB-L2...AR.-... a MGB-L1...AP.-... / MGB-L2...AP.-... od V3.0.0	2119167	04-05/18		 4.0 MB
Instruktionsbok MGB-L1...AR.-... / MGB-L2...AR.-... och MGB-L1...AP.-... / MGB-L2...AP.-... fr. V3.0.0	2119167	04-05/18		 3.7 MB
İşletim kılavuzu MGB-L1...AR.-... / MGB-L2...AR.-... ve MGB-L1...AP.-... / MGB-L2...AP.-... itibaren V3.0.0	2119167	04-05/18		 4.1 MB
操作指示書 安全システム MGB-L1...-AR.-... / MGB-L2...-AR.-... および MGB-L1...-AP.-... / MGB-L2...-AP.-... V3.0.0以降	2119167	04-05/18		 4.1 MB
使用说明书 安全系统 MGB-L1...-AR.-... / MGB-L2...-AR.-...和MGB-L1...-AP.-... / MGB-L2...-AP.-... V3.0.0以上	2119167	04-05/18		 4.1 MB







▼ Sicherheitsinformation (Teil der Betriebsanleitung Sicherheitssystem MGB-AR/MGB-AP) ab V3.0.0

	Doc. no.	Version	Language	Download
Sicherheitsinformation (Teil der Betriebsanleitung Sicherheitssystem MGB-AR/MGB-AP) ab V3.0.0 Información de seguridad (parte del manual de instrucciones Sistema de seguridad MGB-AR/MGB-AP) V3.0.0 o superior Information de sécurité (partie du mode d'emploi Système de sécurité MGB-AR/MGB-AP) à partir de V3.0.0 Informazioni sulla sicurezza (Parte delle istruzioni di impiego Sistema di sicurezza MGB-AR/MGB-AP) da V3.0.0 Säkerhetsinformation (Del av instruktionsboken Säkerhetssystem MGB-AR/MGB-AP) från V3.0.0 Safety Information (Part of the Operating Instructions Safety System MGB-AR/MGB-AP) from V3.0.0	123151	01-02/15	     	 0.6 MB
Veiligheidsinformatie (Deel van de handleiding Beveiligingssysteem MGB-AR/MGB-AP) vanaf V3.0.0	123151	01-02/15		 0.2 MB
Informação de segurança (Parte do manual de instruções Sistema de segurança MGB-AR/MGB-AP) a partir de V3.0.0	123151	01-02/15		 0.2 MB
Bezpečnostní informace (součást návodu k použití „Bezpečnostní systém MGB-AR/MGB-AP“) od V3.0.0	123151	01-02/15		 0.2 MB
Informacje o bezpieczeństwie (Część instrukcji obsługi System bezpieczeństwa MGB-AR/MGB-AP) od V3.0.0	123151	01-02/15		 0.2 MB
Информация о безопасности (часть инструкции по эксплуатации Предохранительная система MGB-AR/MGB-AP) с V3.0.0	123151	01-02/15		 0.3 MB
Bezpečnostná informácia (časť návodu na prevádzku Bezpečnostný systém MGB-AR/MGB-AP) od V3.0.0	123151	01-02/15		 0.2 MB
Güvenlik bilgisi (İşletim kılavuzunun parçası emniyet sistemi MGB-AR/MGB-AP) V3.0.0 ve üstü	123151	01-02/15		 0.3 MB
安全信息 (安全系统 MGB-AR/MGB-AP使用说明书的组成部分) V3.0.0以上	123151	01-02/15		 0.3 MB
安全情報 MGB-AR/MGB-AP	123151	01-02/15		 0.6 MB

## Declaration of conformity

▼ EU-Konformitätserklärung

**Doc. no.    Version    Language    Download**

EU-Konformitätserklärung	2123150	08-01/17		 0.3 MB
Declaración UE de conformidad				
Déclaration UE de conformité				
Dichiarazione di conformità				
EU declaration of conformity				

**CAD data**

CAD data for this item on TraceParts