

ITEM 110958 MGB-LOH-ARA-L-110958

Description	Technical data	Accessories	Downloads
-------------	----------------	-------------	-----------

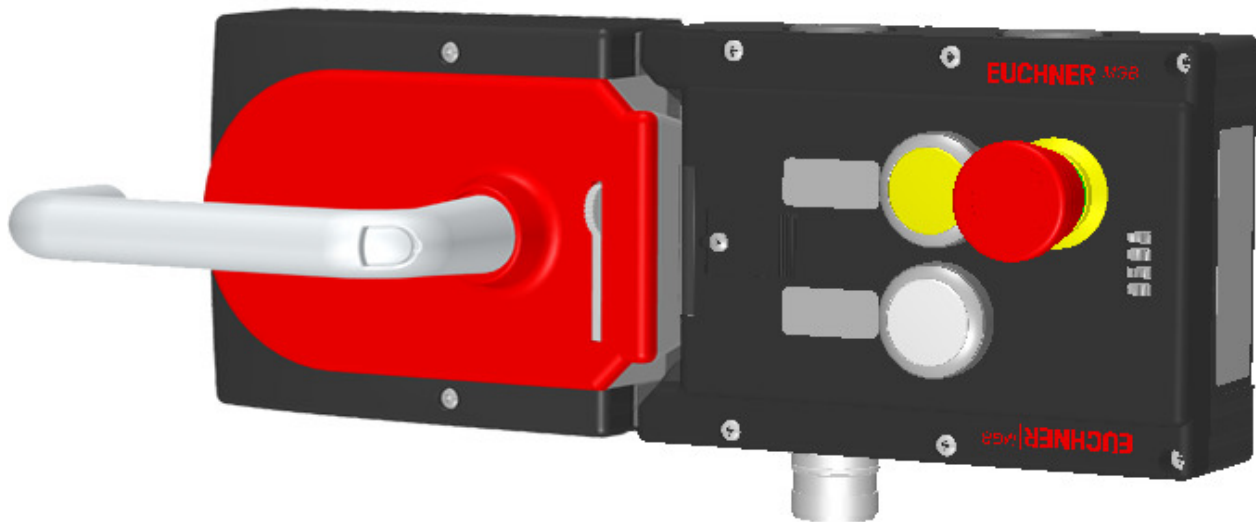

Features

- › Locking (without guard locking)
- › Can be connected in series with other AR devices (e.g. CES-AR and CET-AR)
- › Emergency stop according to ISO 13850
- › 2 pushbuttons (illuminated, ye, wh)
- › Incl. adhesive labels
- › With plug connector RC18
- › Unicode

Guard locking type

MGB- The bolt tongue in the handle module is moved into and out of the **LO...** interlocking module by actuating the door handle. The door arm is not locked in the locked position.

Door hinge

A mechanical door stop is permanently integrated into the evaluation module of the MGB. A marking on the stop makes adjustment easier.

LED indicator

The LED indicator indicates all important system and status information.

Monitoring outputs

- OT** Bolt tongue inserted in the evaluation module
 - OI** Diagnostics; there is a fault
-

Emergency stop device

- S1** 2 positively driven NC contacts, emergency stop with turn-to-reset, not illuminated
-

Pushbutton

- S2** 1 NO contact, yellow, illuminated
 - S3** 1 NO contact, white, illuminated
-

Adhesive labels

Devices with adhesive labels have pre-formed recesses. The adhesive labels enclosed (standard size 12.5 x 27 mm) can be affixed in these recesses.

Components included in the set



116302 Interlocking module MGB-L0-ARA-AA2A1-S1-L-116302
▼ Features



106619 Handle module MGB-H-AA1A1-L-106619
▼ Features

Dimension drawing

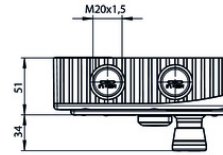
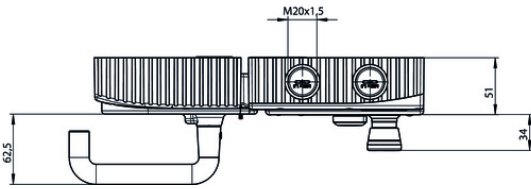
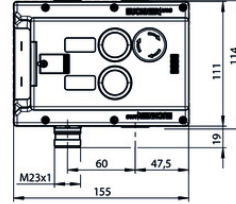
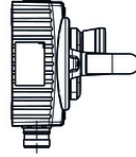
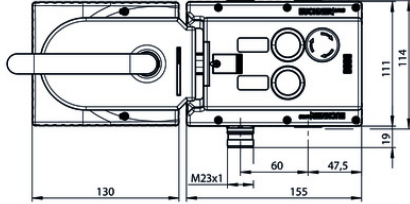
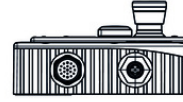
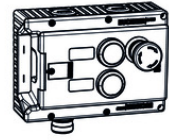
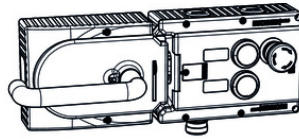
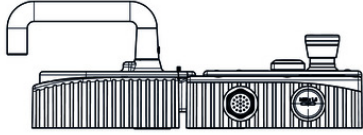

Dimension drawing

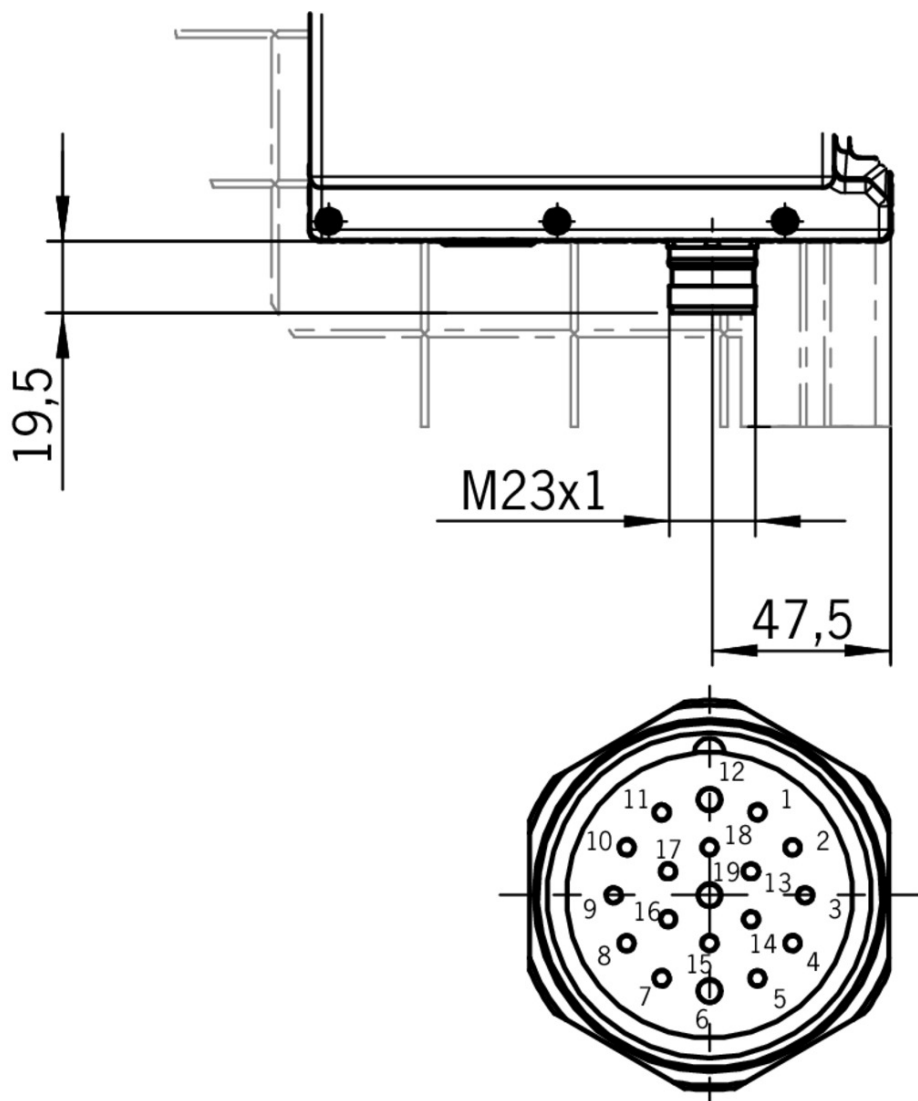

Plug connector RC18

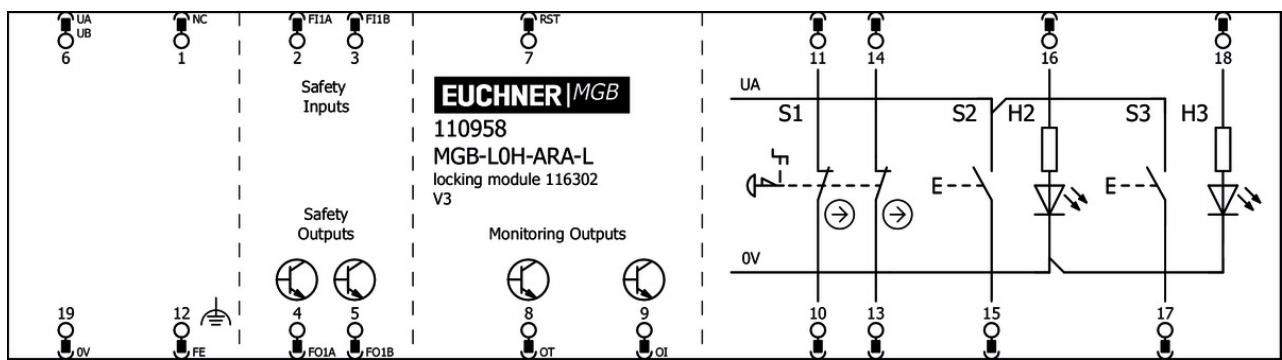

Spare parts

- ✓ Interlocking module MGB-L0-ARA..., with 2 push buttons, emergency stop, incl. label carrier, RC 18



116302 MGB-L0-ARA-AA2A1-S1-L-116302

- ✓ Features

- › Locking (without guard locking)
- › Can be connected in series with other AR devices (e.g. CES-AR and CET-AR)
- › Emergency stop according to ISO 13850
- › 2 pushbuttons (illuminated, ye, wh)
- › Incl. adhesive labels
- › With plug connector RC18
- › Unicode

▼ Handle module MGB-H...



106619 MGB-H-AA1A1-L-106619

▼ Features

- › Intelligent bolt tongue
- › Lockout bar
- › Door handle

Function expansion

▼ Escape release MGB-E-A...



100465 MGB-E-A-100465

▼ Features

- › Escape release from the danger zone
- › Door handle signal red
- › Extended actuation axis for thicker doors (available optionally)

▼ Door knob for MGB-H...



111460 MGB-A-DOORKNOB-S1-111460

▼ Features

- › Aluminum, silver anodized
- › For mounting on all MGB handle modules MGB-H... up to V2.0.0
- › e.g. on sliding doors



124030 MGB-A-DOORKNOB-S2-124030

▼ Features

- › Aluminum, silver anodized
- › For mounting on all MGB handle modules MGB-H... from V3.0.0
- › e.g. on sliding doors

▼ Door handle for MGB-H...



110277 MGB-A-DOORHANDLE-S1-110277

▼ Features

- › Aluminum silver anodized
- › For mounting on all MGB handle modules MGB-H up to V2.0.0



123926 MGB-A-DOORHANDLE-S2-123926

▼ Features

- › Aluminum silver anodized
 - › For mounting on all MGB handle modules MGB-H from V3.0.0
-

▼ Emergency unlocking for safety system MGB



112989 MGB-A-EMERGENCYRELEASE-112989

▼ Features

- › Quick emergency unlocking
 - › sealable
-

Mounting accessories

▼ Mounting plate for evaluation modules MGB-L.-AR.-... and MGB-L.-AP.-...



109490 MGB-A-MOUNTINGPLATE-L-109490

▼ Features

- › Easy and quick mounting (only two screws required)
 - › Quick module replacement
 - › Steel, powder-coated
 - › Suitable for doors hinged on the right or left
-

▼ Mounting plate for all MGB handle modules



109491 MGB-A-MOUNTINGPLATE-H-109491

▼ Features

- › Easy and quick mounting (only two screws required)
 - › Quick module replacement
 - › Steel, powder-coated
 - › Suitable for doors hinged on the right or left
-

Connection material

▼ Female plug RC18 straight with option C1825



077025 RC18EF-C1825

▼ Features

- › Plug connector M23, straight
 - › Number of pins: 19-pin with screen bonding clamp
-

▼ Connection cable with plug connector M23, 19-pin, 1.5m, straight



110301 C-M23F19-19XDIFPU01,5-MA-110301

▼ Features

- › M23 female plug, 19-pin
- › Straight plug connector
- › PUR cable
- › Cable length 1.5 m
- › With flying lead
- › Cores numbered, black

-
- ▼ Connection cable with plug connector M23 with option C1825, 25m, straight



092727 C-M23F19-19XDIFPU25,0-MA-092727

▼ Features

- › M23 plug connector, 18-pin + PE
 - › Straight plug connector
 - › PUR cable
 - › Cable length 25 m
 - › With flying lead
 - › Cores color-coded
-

- ▼ Connection cable with plug connector M23 with option C1825, 20m, straight



092726 C-M23F19-19XDIFPU20,0-MA-092726

▼ Features

- › M23 plug connector, 18-pin + PE
 - › Straight plug connector
 - › PUR cable
 - › Cable length 20 m
 - › With flying lead
 - › Cores color-coded
-

- ▼ Connection cable with plug connector M23 with option C1825, 15m, straight



077016 C-M23F19-19XDIFPU15,0-MA-077016

▼ Features

- › M23 plug connector, 18-pin + PE
 - › Straight plug connector
 - › PUR cable
 - › Cable length 15 m
 - › With flying lead
 - › Cores color-coded
-

- ▼ Connection cable with plug connector M23 with option C1825, 8m, straight



077015 C-M23F19-19XDIFPU08,0-MA-077015

▼ Features

- › M23 plug connector, 18-pin + PE
 - › Straight plug connector
 - › PUR cable
 - › Cable length 8 m
 - › With flying lead
 - › Cores color-coded
-

- ▼ Connection cable with plug connector M23 with option C1825, 10m, straight



092898 C-M23F19-19XDIFPU10,0-MA-092898

▼ Features

- › M23 plug connector, 18-pin + PE
- › Straight plug connector
- › PUR cable
- › Cable length 10 m

- › With flying lead
 - › Cores color-coded
-

▼ Connection cable with plug connector M23 with option C1825, 6m, straight



077014 C-M23F19-19XDIFPU06,0-MA-077014

▼ Features

- › M23 plug connector, 18-pin + PE
 - › Straight plug connector
 - › PUR cable
 - › Cable length 6 m
 - › With flying lead
 - › Cores color-coded
-

▼ Connection cable with plug connector M23 with option C1825, 1.5m, straight



092761 C-M23F19-19XDIFPU01,5-MA-092761

▼ Features

- › M23 plug connector, 18-pin + PE
 - › Straight plug connector
 - › PUR cable
 - › Cable length 1.5 m
 - › With flying lead
 - › Cores color-coded
-

▼ Connection cable with plug connector M23 with option C1825, 3m, straight



092816 C-M23F19-19XDIFPU03,0-MA-092816

▼ Features

- › M23 plug connector, 18-pin + PE
 - › Straight plug connector
 - › PUR cable
 - › Cable length 3 m
 - › With flying lead
 - › Cores color-coded
-

▼ Connection cable with plug connector M23 with option C1825, 40m, straight



102490 C-M23F19-19XDIFPU40,0-MA-102490

▼ Features

- › M23 plug connector, 18-pin + PE
 - › Straight plug connector
 - › PUR cable
 - › Cable length 40 m
 - › With flying lead
 - › Cores color-coded
-

▼ Connection cable with plug connector M23 with option C1825, 30m, straight



095993 C-M23F19-19XDIFPU30,0-MA-095993

▼ Features

- › M23 plug connector, 18-pin + PE

- › Straight plug connector
 - › PUR cable
 - › Cable length 30 m
 - › With flying lead
 - › Cores color-coded
-

Miscellaneous accessories

▼ Lens set 5 colors



120344 AY-SET-LNS-0001-120344

▼ Lens set 6 colors



120378 AY-SET-LNS-0002-120378

▼ Lens set labeled



120377 AY-SET-LNS-SY01-120377



125359 AY-SET-LNS-SY02-125359



126158 AY-SET-LNS-SY03-126158

▼ Adhesive labels

114529 MGB-A-PLATESET-NN01-114529

▼ Features

- › Adhesive labels suitable for MGB evaluation modules, bus modules and control modules
 - › silver, blank
 - › Packaging unit = 10 pcs.
-

▼ Lens set, three colors



158307 AY-SET-LNS-SY04-158307















Instructions

- ▼ Návod k použití – bezpečnostní systémy MGB-L0...-AR.-... a MGB-L0...-AP.-... od V3.0.0

	Doc. no.	Version	Language	Download
Betriebsanleitung MGB-L0...AR-... und MGB-L0...AP-... ab V3.0.0	2112657	13-05/18		2.9 MB
Mode d'emploi MGB-L0...AR-... et MGB-L0...AP-... à partir de V3.0.0	2112657	13-05/18		3.0 MB
Manual de instrucciones MGB-L0...AR-... y MGB-L0...AP-... V3.0.0 o superior	2112657	13-05/18		2.9 MB
Návod k použití – bezpečnostní systémy MGB-L0...-AR-... a MGB-L0...-AP-... od V3.0.0	2112657	13-05/18		3.2 MB
Operating Instructions MGB-L0...AR-... and MGB-L0...AP-... from V3.0.0	2112657	13-05/18		2.9 MB
Istruzioni di impiego per MGB-L0...AR-... e MGB-L0...AP-... da V3.0.0	2112657	13-05/18		2.9 MB
Instrukcja obsługi MGB-L0...AR-... i MGB-L0...AP-... od V3.0.0	2112657	13-05/18		3.2 MB
Manual de instruções MGB-L0...AR-... e MGB-L0...AP-... a partir de V3.0.0	2112657	13-05/18		2.9 MB
Инструкция по эксплуатации MGB-L0...AR-... и MGB-L0...AP-... с V3.0.0	2112657	13-05/18		3.4 MB
Instruktionsbok MGB-L0...AR-... och MGB-L0...AP-... fr. V3.0.0	2112657	13-05/18		2.9 MB
操作指示書 安全システム MGB-L0...-AR-... および MGB-L0...-AP-... V3.0.0以降	2112657	13-05/18		3.3 MB
使用说明书 安全系统 MGB-L0...-AR-...和MGB-L0...-AP-... V3.0.0以上	2112657	13-05/18		3.3 MB







Sicherheitsinformation (Teil der Betriebsanleitung Sicherheitssystem MGB-AR/MGB-AP) ab V3.0.0

	Doc. no.	Version	Language	Download
Sicherheitsinformation (Teil der Betriebsanleitung Sicherheitssystem MGB-AR/MGB-AP) ab V3.0.0	123151	01-02/15	 	0.6 MB
Información de seguridad (parte del manual de instrucciones Sistema de seguridad MGB-AR/MGB-AP) V3.0.0 o superior				
Information de sécurité (partie du mode d'emploi Système de sécurité MGB-AR/MGB-AP) à partir de V3.0.0				
Informazioni sulla sicurezza (Parte delle istruzioni di impiego Sistema di sicurezza MGB-AR/MGB-AP) da V3.0.0				
Säkerhetsinformation (Del av instruktionsboken Säkerhetssystem MGB-AR/MGB-AP) från V3.0.0				
Safety Information (Part of the Operating Instructions Safety System MGB-AR/MGB-AP) from V3.0.0				
Veiligheidsinformatie (Deel van de handleiding Beveiligingssysteem MGB-AR/MGB-AP) vanaf V3.0.0	123151	01-02/15		0.2 MB

Informação de segurança (Parte do manual de instruções Sistema de segurança MGB-AR/MGB-AP) a partir de V3.0.0	123151	01-02/15		 0.2 MB
Bezpečnostní informace (součást návodu k použití „Bezpečnostní systém MGB-AR/MGB-AP“) od V3.0.0	123151	01-02/15		 0.2 MB
Informacje o bezpieczeństwie (Część instrukcji obsługi System bezpieczeństwa MGB-AR/MGB-AP) od V3.0.0	123151	01-02/15		 0.2 MB
Информация о безопасности (часть инструкции по эксплуатации Предохранительная система MGB-AR/MGB-AP) с V3.0.0	123151	01-02/15		 0.3 MB
Bezpečnostná informácia (časť návodu na prevádzku Bezpečnostný systém MGB-AR/MGB-AP) od V3.0.0	123151	01-02/15		 0.2 MB
Güvenlik bilgisi (İşletim kılavuzunun parçası emniyet sistemi MGB-AR/MGB-AP) V3.0.0 ve üstü	123151	01-02/15		 0.3 MB
安全信息 (安全系统 MGB-AR/MGB-AP使用说明书的组成部分) V3.0.0以上	123151	01-02/15		 0.3 MB
安全情報 MGB-AR/MGB-AP	123151	01-02/15		 0.6 MB

Declaration of conformity

EU-Konformitätserklärung

	Doc. no.	Version	Language	Download
EU-Konformitätserklärung	2123150	08-01/17		 0.3 MB
Declaración UE de conformidad				
Déclaration UE de conformité				
Dichiarazione di conformità				
EU declaration of conformity				

CAD data

CAD data for this item on TraceParts