

## ITEM 111534 MGB-L1HE-ARA-L-111534

Description	Technical data	Accessories	Downloads
-------------	----------------	-------------	-----------

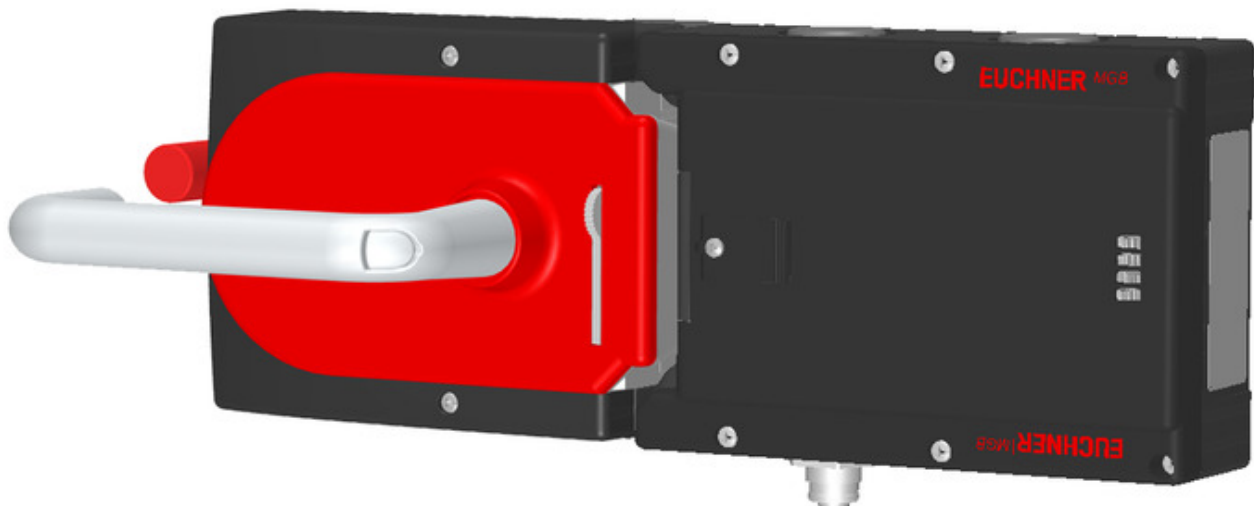

### Features

- › Guard locking with guard lock monitoring
- › Can be connected in series with other AR devices (e.g. CES-AR and CET-AR)
- › With plug connector M12
- › With escape release
- › Unicode

### Guard locking type

**MGB-** The locking arm is held in the locked position by spring force and is  
**L1...** unlocked by solenoid force (closed-circuit current principle, mechanically locked).

### Door hinge

A mechanical door stop is permanently integrated into the evaluation module of the MGB. A marking on the stop makes adjustment easier.

### LED indicator

The LED indicator indicates all important system and status information.

## Monitoring outputs

- OD** ON when the door is closed
  - OT** Bolt tongue inserted in the evaluation module
  - OL** Guard locking solenoid in locked position
  - OI** Diagnostics; there is a fault
- 

## Escape release

The escape release enables persons who are accidentally locked in to open the locked door from inside the danger area.

## Components included in the set



111533 Locking module MGB-L1-ARA-AA1A1-S4-L-111533  
✓ Features

---



106619 Handle module MGB-H-AA1A1-L-106619  
✓ Features

---



100465 Escape release MGB-E-A-100465  
✓ Features

---

# Dimension drawing

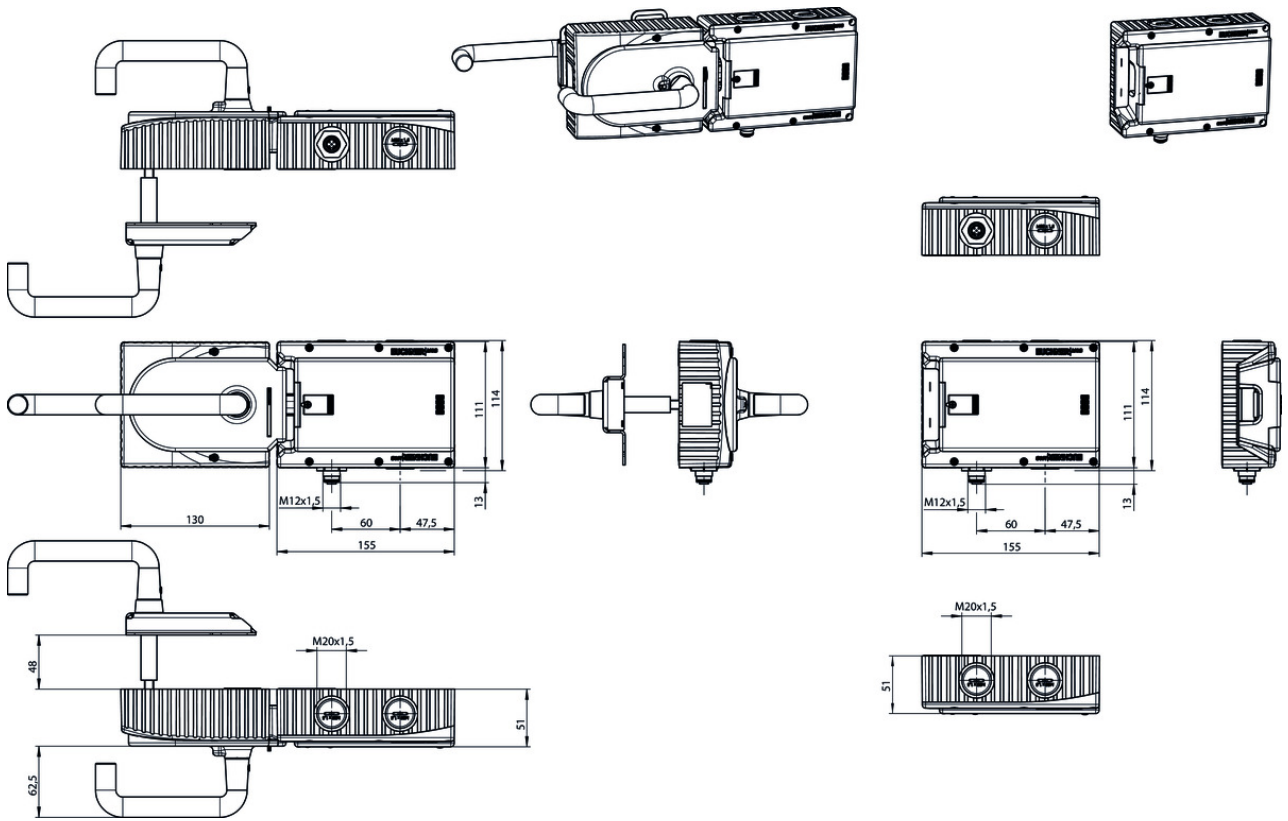

**Dimension drawing**

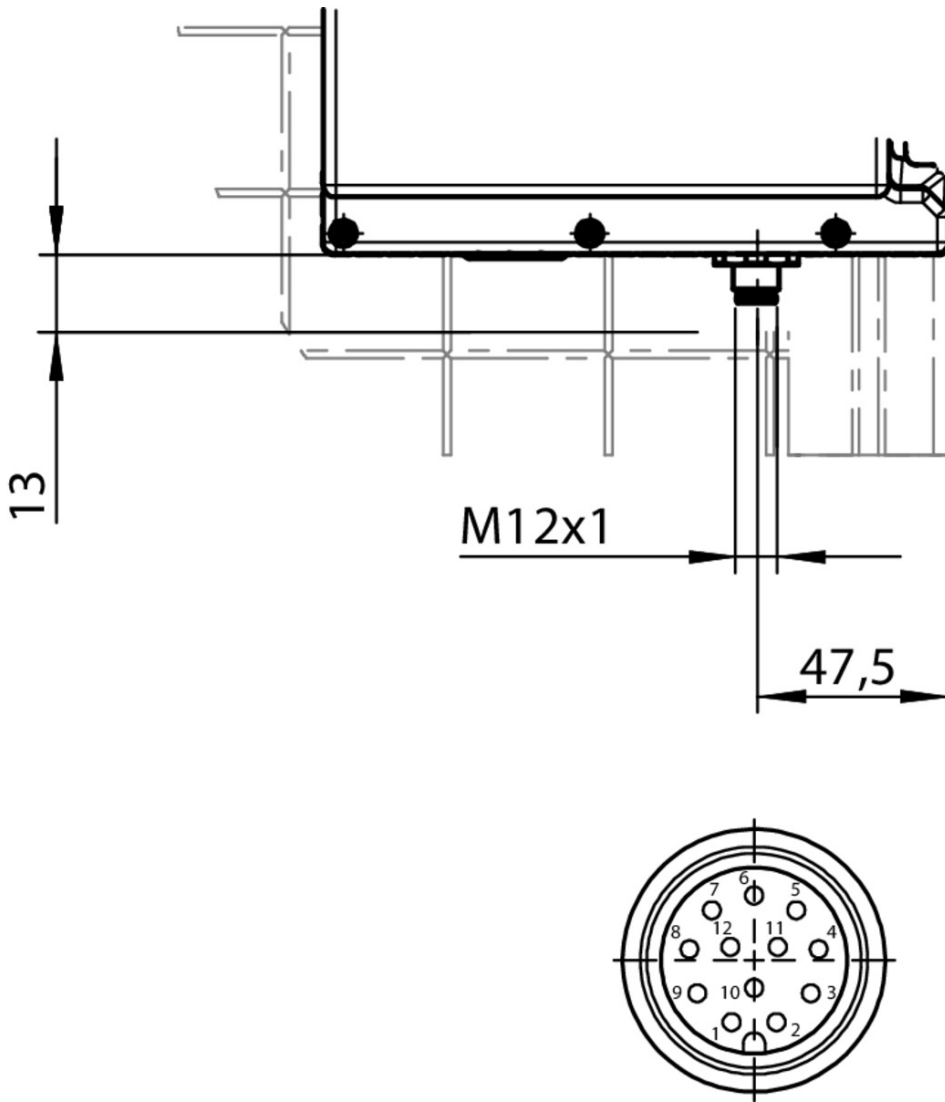

**Plug connector M12**

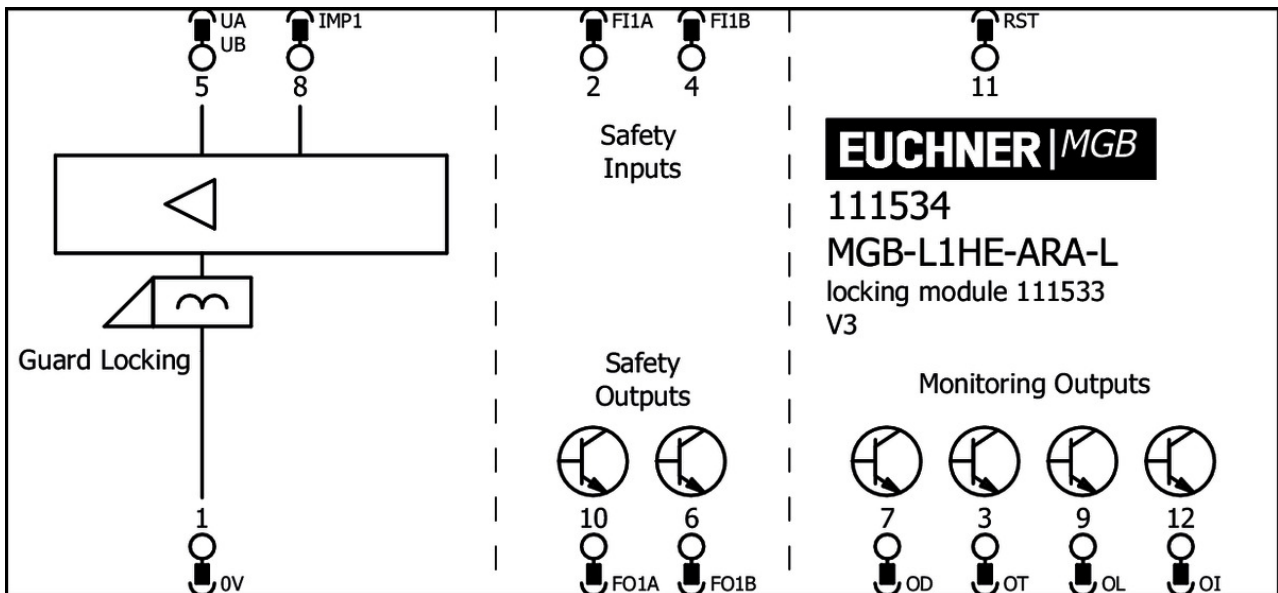

## Function expansion

---

### ☑ Door handle for MGB-H...



**110277** MGB-A-DOORHANDLE-S1-110277

#### ☑ Features

- › Aluminum silver anodized
  - › For mounting on all MGB handle modules MGB-H up to V2.0.0
- 



**123926** MGB-A-DOORHANDLE-S2-123926

#### ☑ Features

- › Aluminum silver anodized
  - › For mounting on all MGB handle modules MGB-H from V3.0.0
- 

### ☑ Door knob for MGB-H...



**111460** MGB-A-DOORKNOB-S1-111460

#### ☑ Features

- › Aluminum, silver anodized
  - › For mounting on all MGB handle modules MGB-H... up to V2.0.0
  - › e.g. on sliding doors
- 



**124030** MGB-A-DOORKNOB-S2-124030

#### ☑ Features

- › Aluminum, silver anodized
  - › For mounting on all MGB handle modules MGB-H... from V3.0.0
  - › e.g. on sliding doors
- 

### ☑ Emergency unlocking for safety system MGB



**112989** MGB-A-EMERGENCYRELEASE-112989

#### ☑ Features

- › Quick emergency unlocking
  - › sealable
- 

### ☑ Door handle for MGB-E...



**110276** MGB-A-DOORHANDLE-R1-110276

#### ☑ Features

- › Aluminum, red painted
  - › For mounting on all MGB escape release modules MGB-E
- 

### ☑ Door knob for MGB-E...



**114904** MGB-A-DOORKNOB-R1-114904

#### ☑ Features

- › Aluminum, red painted
- › For mounting on all MGB escape release modules MGB-E
- › e.g. on sliding doors

---

▼ Escape release MGB-E-A...



**100465** MGB-E-A-100465

▼ Features

- › Escape release from the danger zone
  - › Door handle signal red
  - › Extended actuation axis for thicker doors (available optionally)
- 

▼ Extended actuation axis for MGB-E...



**106761** AY-ERS-250-106761

---

## Spare parts

▼ Locking module MGB-L1-ARA..., (guard locking by spring force) without controls or indicators, M12



**111533** MGB-L1-ARA-AA1A1-S4-L-111533

▼ Features

- › Guard locking with guard lock monitoring
  - › Can be connected in series with other AR devices (e.g. CES-AR and CET-AR)
  - › With plug connector M12
  - › Unicode
- 

▼ Handle module MGB-H...



**106619** MGB-H-AA1A1-L-106619

▼ Features

- › Intelligent bolt tongue
  - › Lockout bar
  - › Door handle
- 

## Mounting accessories

▼ Mounting plate for escape release



**109492** MGB-A-MOUNTINGPLATE-E-109492

▼ Features

- › Easy and quick mounting (only two screws required)
  - › Quick module replacement
  - › Steel, powder-coated
  - › Suitable for doors hinged on the right or left
- 

▼ Mounting plate for evaluation modules MGB-L.-AR.-... and MGB-L.-AP.-...

**109490** MGB-A-MOUNTINGPLATE-L-109490



- ✓ Features
  - › Easy and quick mounting (only two screws required)
  - › Quick module replacement
  - › Steel, powder-coated
  - › Suitable for doors hinged on the right or left

✓ Mounting plate for all MGB handle modules



- 109491** MGB-A-MOUNTINGPLATE-H-109491
- ✓ Features
    - › Easy and quick mounting (only two screws required)
    - › Quick module replacement
    - › Steel, powder-coated
    - › Suitable for doors hinged on the right or left

## Miscellaneous accessories

✓ Lens set 6 colors



**120378** AY-SET-LNS-0002-120378

✓ Lens set 5 colors



**120344** AY-SET-LNS-0001-120344

✓ Lens set labeled



**120377** AY-SET-LNS-SY01-120377



**126158** AY-SET-LNS-SY03-126158







**125359** AY-SET-LNS-SY02-125359

## Instructions

























- ✓ Návod k použití – bezpečnostní systémy MGB-L1...AR.-... / MGB-L2...AR.-... a MGB-L1...AP.-... / MGB-L2...AP.-... od V3.0.0

	Doc. no.	Version	Language	Download
Betriebsanleitung MGB-L1...AR.-... / MGB-L2...AR.-... und MGB-L1...AP.-... / MGB-L2...AP.-... ab V3.0.0	2119167	04-05/18		3.7 MB

Mode d'emploi MGB-L1...AR.-... / MGB-L2...AR.-... et MGB-L1...AP.-... / MGB-L2...AP.-... à partir de V3.0.0	2119167	04-05/18		 3.7 MB
Manual de instrucciones MGB-L1...AR.-... / MGB- L2...AR.-... y MGB-L1...AP.-... / MGB-L2...AP.-... V3.0.0 o superior	2119167	04-05/18		 3.7 MB
Návod k použití – bezpečnostní systémy MGB- L1...AR.-... / MGB-L2...AR.-... a MGB-L1...AP.-... / MGB-L2...AP.-... od V3.0.0	2119167	04-05/18		 4.0 MB
Operating Instructions MGB-L1...AR.-... / MGB- L2...AR.-... and MGB-L1...AP.-... / MGB-L2...AP.-... from V3.0.0	2119167	04-05/18		 3.7 MB
Istruzioni di impiego MGB-L1...AR.-... / MGB- L2...AR.-... und MGB-L1...AP.-... / MGB-L2...AP.-... da V3.0.0	2119167	04-05/18		 3.7 MB
Handleiding MGB-L1...AR.-... / MGB-L2...AR.-... en MGB-L1...AP.-... / MGB-L2...AP.-... vanaf V3.0.0	2119167	04-05/18		 3.7 MB
Instrukcja obsługi MGB-L1...AR.-... / MGB-L2...AR.- ... i MGB-L1...AP.-... / MGB-L2...AP.-... od V3.0.0	2119167	04-05/18		 4.0 MB
Manual de instruções MGB-L1...AR.-... / MGB- L2...AR.-... e MGB-L1...AP.-... / MGB-L2...AP.-... a partir de V3.0.0	2119167	04-05/18		 3.7 MB
Инструкция по эксплуатации MGB-L1...AR.-... / MGB-L2...AR.-... и MGB-L1...AP.-... / MGB-L2...AP.- ... с V3.0.0	2119167	04-05/18		 4.2 MB
Návod na prevádzku Bezpečnostné systémy MGB-L1...AR.-... / MGB-L2...AR.-... a MGB-L1...AP.- ... / MGB-L2...AP.-... od V3.0.0	2119167	04-05/18		 4.0 MB
Instruktionsbok MGB-L1...AR.-... / MGB-L2...AR.-... och MGB-L1...AP.-... / MGB-L2...AP.-... fr. V3.0.0	2119167	04-05/18		 3.7 MB
İşletim kılavuzu MGB-L1...AR.-... / MGB-L2...AR.-... ve MGB-L1...AP.-... / MGB-L2...AP.-... itibaren V3.0.0	2119167	04-05/18		 4.1 MB
操作指示書 安全システム MGB-L1...-AR.-... / MGB- L2...-AR.-... および MGB-L1...-AP.-... / MGB-L2...- AP.-... V3.0.0以降	2119167	04-05/18		 4.1 MB
使用说明书 安全系统 MGB-L1...-AR.-... / MGB-L2...- AR.-...和MGB-L1...-AP.-... / MGB-L2...-AP.-... V3.0.0 以上	2119167	04-05/18		 4.1 MB







 Sicherheitsinformation (Teil der Betriebsanleitung Sicherheitssystem MGB-AR/MGB-AP) ab  
V3.0.0

**Doc. no.**   **Version**   **Language**   **Download**

Sicherheitsinformation (Teil der Betriebsanleitung Sicherheitssystem MGB-AR/MGB-AP) ab V3.0.0 Información de seguridad (parte del manual de instrucciones Sistema de seguridad MGB-AR/MGB-AP) V3.0.0 o superior Information de sécurité (partie du mode d'emploi Système de sécurité MGB-AR/MGB-AP) à partir de V3.0.0 Informazioni sulla sicurezza (Parte delle istruzioni di impiego Sistema di sicurezza MGB-AR/MGB-AP) da V3.0.0 Säkerhetsinformation (Del av instruktionsboken Säkerhetssystem MGB-AR/MGB-AP) från V3.0.0 Safety Information (Part of the Operating Instructions Safety System MGB-AR/MGB-AP) from V3.0.0	123151	01-02/15	     	 0.6 MB
Veiligheidsinformatie (Deel van de handleiding Beveiligingssysteem MGB-AR/MGB-AP) vanaf V3.0.0	123151	01-02/15		 0.2 MB
Informação de segurança (Parte do manual de instruções Sistema de segurança MGB-AR/MGB-AP) a partir de V3.0.0	123151	01-02/15		 0.2 MB
Bezpečnostní informace (součást návodu k použití „Bezpečnostní systém MGB-AR/MGB-AP“) od V3.0.0	123151	01-02/15		 0.2 MB
Informacje o bezpieczeństwie (Część instrukcji obsługi System bezpieczeństwa MGB-AR/MGB-AP) od V3.0.0	123151	01-02/15		 0.2 MB
Информация о безопасности (часть инструкции по эксплуатации Предохранительная система MGB-AR/MGB-AP) с V3.0.0	123151	01-02/15		 0.3 MB
Bezpečnostná informácia (časť návodu na prevádzku Bezpečnostný systém MGB-AR/MGB-AP) od V3.0.0	123151	01-02/15		 0.2 MB
Güvenlik bilgisi (İşletim kılavuzunun parçası emniyet sistemi MGB-AR/MGB-AP) V3.0.0 ve üstü	123151	01-02/15		 0.3 MB
安全信息 (安全系统 MGB-AR/MGB-AP使用说明书的组成部分) V3.0.0以上	123151	01-02/15		 0.3 MB
安全情報 MGB-AR/MGB-AP	123151	01-02/15		 0.6 MB

## Declaration of conformity

### EU-Konformitätserklärung

	Doc. no.	Version	Language	Download
EU-Konformitätserklärung Declaración UE de conformidad Déclaration UE de conformité Dichiarazione di conformità EU declaration of conformity	2123150	08-01/17	    	 0.3 MB

## CAD data

