

## ITEM 111656 MGB-L1H-ARA-L-111656

Description	Technical data	Accessories	Downloads
-------------	----------------	-------------	-----------

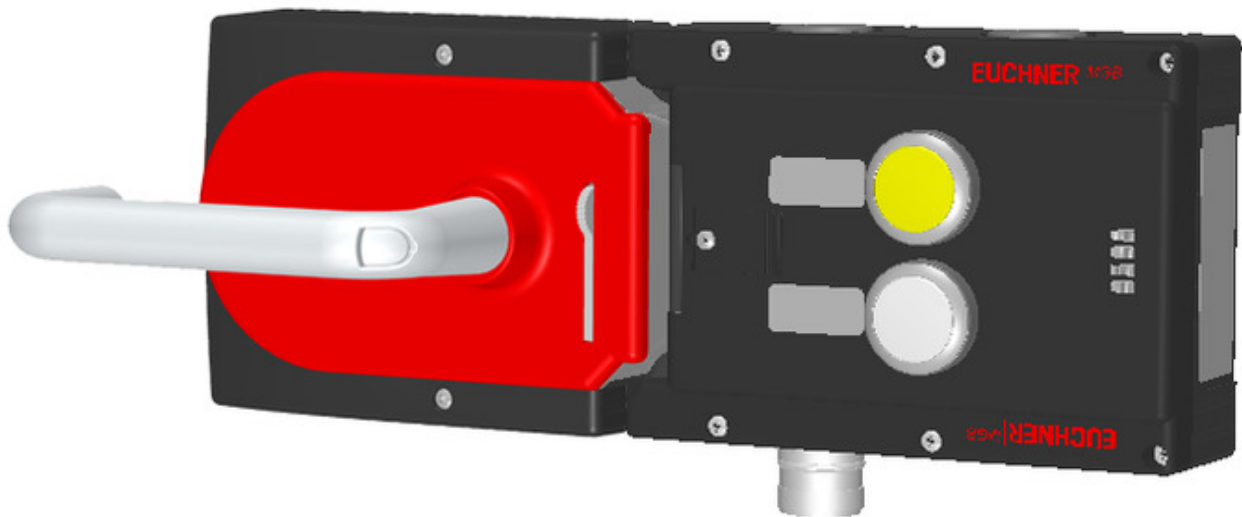

### Features

- › Guard locking with guard lock monitoring
- › Can be connected in series with other AR devices (e.g. CES-AR and CET-AR)
- › 2 pushbuttons (illuminated, ye, wh)
- › Incl. adhesive labels
- › With plug connector RC18
- › Unicode

### Guard locking type

**MGB-** The locking arm is held in the locked position by spring force and is  
**L1...** unlocked by solenoid force (closed-circuit current principle, mechanically locked).

### Door hinge

A mechanical door stop is permanently integrated into the evaluation module of the MGB. A marking on the stop makes adjustment easier.

### LED indicator

The LED indicator indicates all important system and status information.

## Monitoring outputs

- OT** Bolt tongue inserted in the evaluation module
  - OI** Diagnostics; there is a fault
- 

## Pushbutton

- S2** 1 NO contact, yellow, illuminated
  - S3** 1 NO contact, white, illuminated
- 

## Adhesive labels

Devices with adhesive labels have pre-formed recesses. The adhesive labels enclosed (standard size 12.5 x 27 mm) can be affixed in these recesses.

## Components included in the set

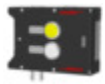

- 111654 Locking module MGB-L1-ARA-AA8A1-S1-L-111654
  - Features
- 



- 106619 Handle module MGB-H-AA1A1-L-106619
  - Features
-

# Dimension drawing

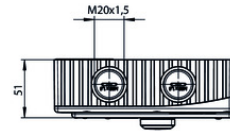
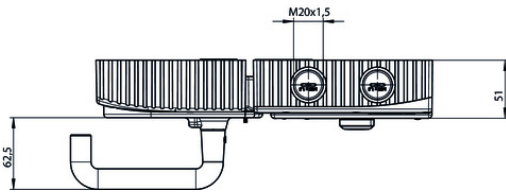
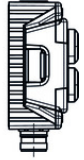
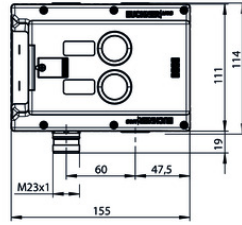
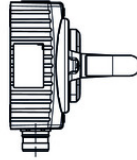
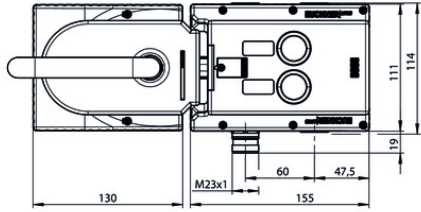
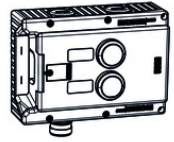
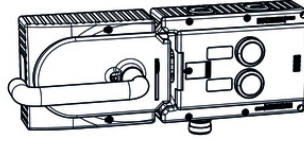
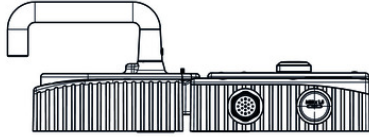

## Dimension drawing

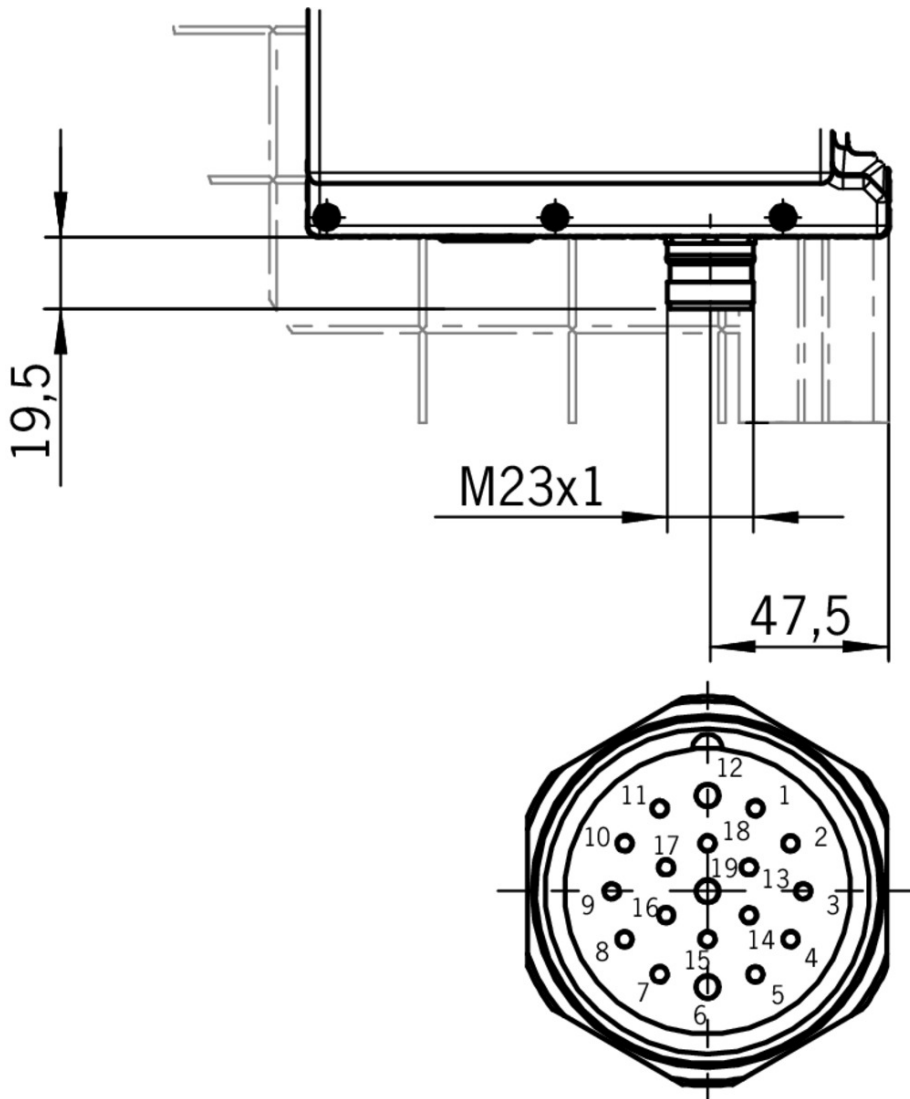

## Plug connector RC18

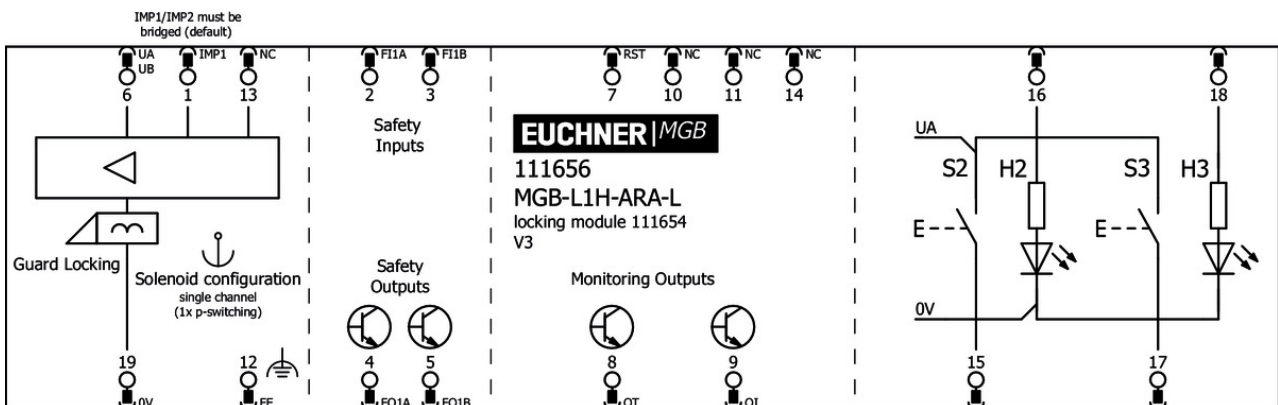

## Function expansion

▼ Escape release MGB-E-A...



**100465** MGB-E-A-100465

▼ Features

- › Escape release from the danger zone
  - › Door handle signal red
  - › Extended actuation axis for thicker doors (available optionally)
- 

▼ Door knob for MGB-H...



**111460** MGB-A-DOORKNOB-S1-111460

▼ Features

- › Aluminum, silver anodized
  - › For mounting on all MGB handle modules MGB-H... up to V2.0.0
  - › e.g. on sliding doors
- 



**124030** MGB-A-DOORKNOB-S2-124030

▼ Features

- › Aluminum, silver anodized
  - › For mounting on all MGB handle modules MGB-H... from V3.0.0
  - › e.g. on sliding doors
- 

▼ Door handle for MGB-H...



**110277** MGB-A-DOORHANDLE-S1-110277

▼ Features

- › Aluminum silver anodized
  - › For mounting on all MGB handle modules MGB-H up to V2.0.0
- 



**123926** MGB-A-DOORHANDLE-S2-123926

▼ Features

- › Aluminum silver anodized
  - › For mounting on all MGB handle modules MGB-H from V3.0.0
- 

▼ Emergency unlocking for safety system MGB



**112989** MGB-A-EMERGENCYRELEASE-112989

▼ Features

- › Quick emergency unlocking
  - › sealable
- 

## Mounting accessories

---

▼ Mounting plate for evaluation modules MGB-L.-AR.-... and MGB-L.-AP.-...



**109490** MGB-A-MOUNTINGPLATE-L-109490

▼ Features

- › Easy and quick mounting (only two screws required)
  - › Quick module replacement
  - › Steel, powder-coated
  - › Suitable for doors hinged on the right or left
-

▼ Mounting plate for all MGB handle modules



**109491** MGB-A-MOUNTINGPLATE-H-109491

▼ Features

- › Easy and quick mounting (only two screws required)
  - › Quick module replacement
  - › Steel, powder-coated
  - › Suitable for doors hinged on the right or left
- 

## Spare parts

---

▼ Locking module MGB-L1-ARA..., (guard locking by spring force) with 2 push buttons, incl. label carrier, RC18



**111654** MGB-L1-ARA-AA8A1-S1-L-111654

▼ Features

- › Guard locking with guard lock monitoring
  - › Can be connected in series with other AR devices (e.g. CES-AR and CET-AR)
  - › 2 pushbuttons (illuminated, ye, wh)
  - › Incl. adhesive labels
  - › With plug connector RC18
  - › Unicode
- 

▼ Handle module MGB-H...



**106619** MGB-H-AA1A1-L-106619

▼ Features

- › Intelligent bolt tongue
  - › Lockout bar
  - › Door handle
- 

## Connection material

---

▼ Connection cable with plug connector M23 with option C1825, 8m, straight



**077015** C-M23F19-19XDIFPU08,0-MA-077015

▼ Features

- › M23 plug connector, 18-pin + PE
  - › Straight plug connector
  - › PUR cable
  - › Cable length 8 m
  - › With flying lead
  - › Cores color-coded
- 

▼ Connection cable with plug connector M23 with option C1825, 10m, straight



**092898** C-M23F19-19XDIFPU10,0-MA-092898

▼ Features

- › M23 plug connector, 18-pin + PE
- › Straight plug connector

- › PUR cable
  - › Cable length 10 m
  - › With flying lead
  - › Cores color-coded
- 

▼ Connection cable with plug connector M23 with option C1825, 15m, straight



**077016** C-M23F19-19XDIFPU15,0-MA-077016

▼ Features

- › M23 plug connector, 18-pin + PE
  - › Straight plug connector
  - › PUR cable
  - › Cable length 15 m
  - › With flying lead
  - › Cores color-coded
- 

▼ Connection cable with plug connector M23 with option C1825, 20m, straight



**092726** C-M23F19-19XDIFPU20,0-MA-092726

▼ Features

- › M23 plug connector, 18-pin + PE
  - › Straight plug connector
  - › PUR cable
  - › Cable length 20 m
  - › With flying lead
  - › Cores color-coded
- 

▼ Connection cable with plug connector M23 with option C1825, 25m, straight



**092727** C-M23F19-19XDIFPU25,0-MA-092727

▼ Features

- › M23 plug connector, 18-pin + PE
  - › Straight plug connector
  - › PUR cable
  - › Cable length 25 m
  - › With flying lead
  - › Cores color-coded
- 

▼ Connection cable with plug connector M23 with option C1825, 30m, straight



**095993** C-M23F19-19XDIFPU30,0-MA-095993

▼ Features

- › M23 plug connector, 18-pin + PE
  - › Straight plug connector
  - › PUR cable
  - › Cable length 30 m
  - › With flying lead
  - › Cores color-coded
- 

▼ Female plug RC18 straight with option C1825

**077025** RC18EF-C1825



- ▼ Features
    - › Plug connector M23, straight
    - › Number of pins: 19-pin with screen bonding clamp
- 

- ▼ Replacement crimp contacts for female connector RC18 with option C1825

**094310** CRIMPKONTAKT BUCHSE RCF-C1825

- ▼ Features
    - › 19 crimp sockets
    - › Conductor cross-section 16 x 0.25 - 0.5 mm<sup>2</sup> and 3 x 0.75 - 1 mm<sup>2</sup>
    - › For plug connector RC18..C1825
- 

- ▼ Connection cable with plug connector M23 with option C1825, 1.5m, straight



**092761** C-M23F19-19XDIFPU01,5-MA-092761

- ▼ Features
    - › M23 plug connector, 18-pin + PE
    - › Straight plug connector
    - › PUR cable
    - › Cable length 1.5 m
    - › With flying lead
    - › Cores color-coded
- 

- ▼ Connection cable with plug connector M23 with option C1825, 3m, straight



**092816** C-M23F19-19XDIFPU03,0-MA-092816

- ▼ Features
    - › M23 plug connector, 18-pin + PE
    - › Straight plug connector
    - › PUR cable
    - › Cable length 3 m
    - › With flying lead
    - › Cores color-coded
- 

- ▼ Connection cable with plug connector M23 with option C1825, 6m, straight



**077014** C-M23F19-19XDIFPU06,0-MA-077014

- ▼ Features
    - › M23 plug connector, 18-pin + PE
    - › Straight plug connector
    - › PUR cable
    - › Cable length 6 m
    - › With flying lead
    - › Cores color-coded
- 

- ▼ Connection cable with plug connector M23 with option C1825, 40m, straight



**102490** C-M23F19-19XDIFPU40,0-MA-102490

- ▼ Features
  - › M23 plug connector, 18-pin + PE
  - › Straight plug connector
  - › PUR cable

- › Cable length 40 m
- › With flying lead
- › Cores color-coded

---

▼ Built-in connector RC18

**120403** MGB-A-PLUGCONNECTOR-RC18-120403

▼ Features

- › For all MGB with cable entry

---

▼ Connection cable with plug connector M23, 19-pin, 30m, straight



**122434** C-M23F19-19XDIFPU30,0-MA-122434

▼ Features

- › M23 female plug, 19-pin
- › Straight plug connector
- › PUR cable
- › Cable length 30 m
- › With flying lead
- › Cores numbered, black

---

## Miscellaneous accessories

▼ Lens set 5 colors



**120344** AY-SET-LNS-0001-120344

---

▼ Lens set 6 colors



**120378** AY-SET-LNS-0002-120378

---

▼ Lens set labeled



**120377** AY-SET-LNS-SY01-120377



**125359** AY-SET-LNS-SY02-125359



**126158** AY-SET-LNS-SY03-126158

---

▼ Adhesive labels

**114529** MGB-A-PLATESET-NN01-114529

▼ Features

- › Adhesive labels suitable for MGB evaluation modules, bus modules and

- control modules
- › silver, blank
- › Packaging unit = 10 pcs.

▼ Lens set, three colors



**158307** AY-SET-LNS-SY04-158307























## Instructions

▼ Návod k použití – bezpečnostní systémy MGB-L1...AR.-... / MGB-L2...AR.-... a MGB-L1...AP.-... / MGB-L2...AP.-... od V3.0.0

	Doc. no.	Version	Language	Download
Betriebsanleitung MGB-L1...AR.-... / MGB-L2...AR.-... und MGB-L1...AP.-... / MGB-L2...AP.-... ab V3.0.0	2119167	04-05/18		3.7 MB
Mode d'emploi MGB-L1...AR.-... / MGB-L2...AR.-... et MGB-L1...AP.-... / MGB-L2...AP.-... à partir de V3.0.0	2119167	04-05/18		3.7 MB
Manual de instrucciones MGB-L1...AR.-... / MGB-L2...AR.-... y MGB-L1...AP.-... / MGB-L2...AP.-... V3.0.0 o superior	2119167	04-05/18		3.7 MB
Návod k použití – bezpečnostní systémy MGB-L1...AR.-... / MGB-L2...AR.-... a MGB-L1...AP.-... / MGB-L2...AP.-... od V3.0.0	2119167	04-05/18		4.0 MB
Operating Instructions MGB-L1...AR.-... / MGB-L2...AR.-... and MGB-L1...AP.-... / MGB-L2...AP.-... from V3.0.0	2119167	04-05/18		3.7 MB
Istruzioni di impiego MGB-L1...AR.-... / MGB-L2...AR.-... und MGB-L1...AP.-... / MGB-L2...AP.-... da V3.0.0	2119167	04-05/18		3.7 MB
Handleiding MGB-L1...AR.-... / MGB-L2...AR.-... en MGB-L1...AP.-... / MGB-L2...AP.-... vanaf V3.0.0	2119167	04-05/18		3.7 MB
Instrukcja obsługi MGB-L1...AR.-... / MGB-L2...AR.-... i MGB-L1...AP.-... / MGB-L2...AP.-... od V3.0.0	2119167	04-05/18		4.0 MB
Manual de instruções MGB-L1...AR.-... / MGB-L2...AR.-... e MGB-L1...AP.-... / MGB-L2...AP.-... a partir de V3.0.0	2119167	04-05/18		3.7 MB
Инструкция по эксплуатации MGB-L1...AR.-... / MGB-L2...AR.-... и MGB-L1...AP.-... / MGB-L2...AP.-... с V3.0.0	2119167	04-05/18		4.2 MB
Návod na prevádzku Bezpečnostné systémy MGB-L1...AR.-... / MGB-L2...AR.-... a MGB-L1...AP.-... / MGB-L2...AP.-... od V3.0.0	2119167	04-05/18		4.0 MB
Instruktionsbok MGB-L1...AR.-... / MGB-L2...AR.-... och MGB-L1...AP.-... / MGB-L2...AP.-... fr. V3.0.0	2119167	04-05/18		3.7 MB

İşletim kılavuzu MGB-L1...AR-... / MGB-L2...AR-... ve MGB-L1...AP-... / MGB-L2...AP-... itibaren V3.0.0	2119167	04-05/18		 4.1 MB
操作指示書 安全システム MGB-L1...-AR-... / MGB- L2...-AR-... および MGB-L1...-AP-... / MGB-L2...- AP-... V3.0.0以降	2119167	04-05/18		 4.1 MB
使用说明书 安全系统 MGB-L1...-AR-... / MGB-L2...- AR-...和MGB-L1...-AP-... / MGB-L2...-AP-... V3.0.0 以上	2119167	04-05/18		 4.1 MB

 **Sicherheitsinformation (Teil der Betriebsanleitung Sicherheitssystem MGB-AR/MGB-AP) ab V3.0.0**

	<b>Doc. no.</b>	<b>Version</b>	<b>Language</b>	<b>Download</b>
Sicherheitsinformation (Teil der Betriebsanleitung Sicherheitssystem MGB- AR/MGB-AP) ab V3.0.0 Información de seguridad (parte del manual de instrucciones Sistema de seguridad MGB- AR/MGB-AP) V3.0.0 o superior Information de sécurité (partie du mode d'emploi Système de sécurité MGB-AR/MGB-AP) à partir de V3.0.0 Informazioni sulla sicurezza (Parte delle istruzioni di impiego Sistema di sicurezza MGB-AR/MGB- AP) da V3.0.0 Säkerhetsinformation (Del av instruktionsboken Säkerhetssystem MGB-AR/MGB-AP) från V3.0.0 Safety Information (Part of the Operating Instructions Safety System MGB-AR/MGB-AP) from V3.0.0	123151	01-02/15	     	 0.6 MB
Veiligheidsinformatie (Deel van de handleiding Beveiligingssysteem MGB-AR/MGB-AP) vanaf V3.0.0	123151	01-02/15		 0.2 MB
Informação de segurança (Parte do manual de instruções Sistema de segurança MGB-AR/MGB- AP) a partir de V3.0.0	123151	01-02/15		 0.2 MB
Bezpečnostní informace (součást návodu k použití „Bezpečnostní systém MGB-AR/MGB-AP“) od V3.0.0	123151	01-02/15		 0.2 MB
Informacje o bezpieczeństwie (Część instrukcji obsługi System bezpieczeństwa MGB-AR/MGB- AP) od V3.0.0	123151	01-02/15		 0.2 MB
Информация о безопасности (часть инструкции по эксплуатации Предохранительная система MGB-AR/MGB-AP) с V3.0.0	123151	01-02/15		 0.3 MB
Bezpečnostná informácia (časť návodu na prevádzku Bezpečnostný systém MGB-AR/MGB- AP) od V3.0.0	123151	01-02/15		 0.2 MB
Güvenlik bilgisi (İşletim kılavuzunun parçası emniyet sistemi MGB-AR/MGB-AP) V3.0.0 ve üstü	123151	01-02/15		 0.3 MB
安全信息 (安全系统 MGB-AR/MGB-AP使用说明书的组 成部分) V3.0.0以上	123151	01-02/15		 0.3 MB



## Catalogs

- Multifunctional Gate Box MGB Multifunctional Gate Box MGB Multifunctional Gate Box MGB  
 Multifunctional Gate Box MGB Multifunctional Gate Box MGB 多功能系统安全控制系统 MGB

	Doc. no.	Version	Language	Download
Multifunctional Gate Box MGB	106108	10-02/18		8.2 MB
Multifunctional Gate Box MGB	109155	10-02/18		8.2 MB
Multifunctional Gate Box MGB	114433	10-02/18		8.3 MB
Multifunctional Gate Box MGB	121652	10-02/18		8.0 MB
Multifunctional Gate Box MGB	106109	10-02/18		8.2 MB
多功能系统安全控制系统 MGB	155883	10-02/18		8.3 MB

## Declaration of conformity

- EU-Konformitätserklärung

	Doc. no.	Version	Language	Download
EU-Konformitätserklärung	2123150	08-01/17		0.3 MB
Declaración UE de conformidad				
Déclaration UE de conformité				
Dichiarazione di conformità				
EU declaration of conformity				

## CAD data

CAD data for this item on TraceParts