

ITEM 111938 MGB-LOHE-ARA-R-111938

Description	Technical data	Accessories	Downloads
-------------	----------------	-------------	-----------

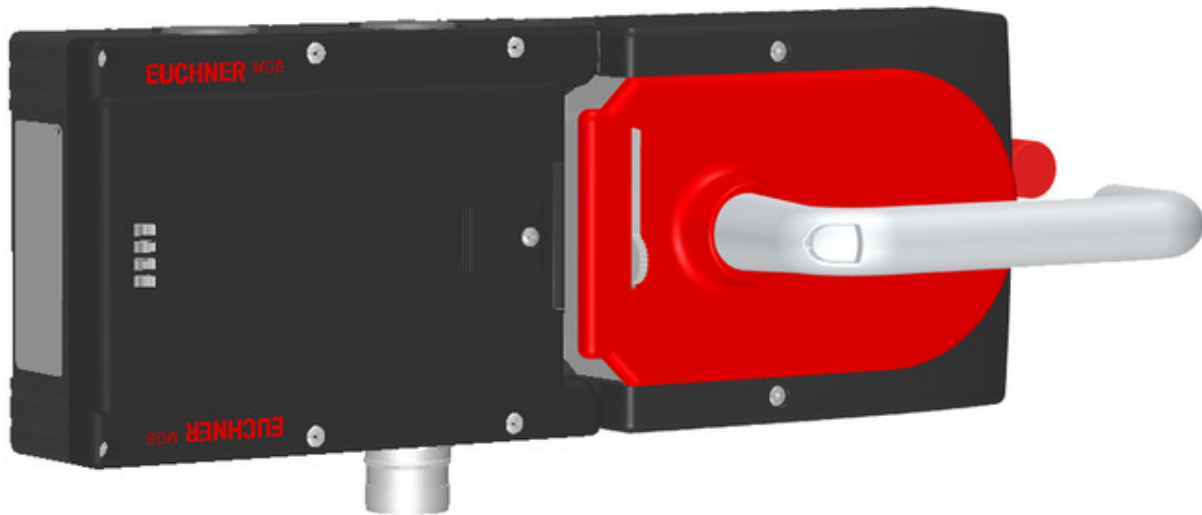

Features

- › Locking (without guard locking)
- › Can be connected in series with other AR devices (e.g. CES-AR and CET-AR)
- › With plug connector RC18
- › With escape release
- › Unicode

Door hinge

A mechanical door stop is permanently integrated into the evaluation module of the MGB. A marking on the stop makes adjustment easier.

LED indicator

The LED indicator indicates all important system and status information.

Monitoring outputs

- OT** Bolt tongue inserted in the evaluation module
- OI** Diagnostics; there is a fault

Components included in the set



111937 Interlocking module MGB-L0-ARA-AA1A1-S1-R-111937

✓ Features



111157 Handle module MGB-H-AA1A3-R-111157

✓ Features



100465 Escape release MGB-E-A-100465

✓ Features

Dimension drawing

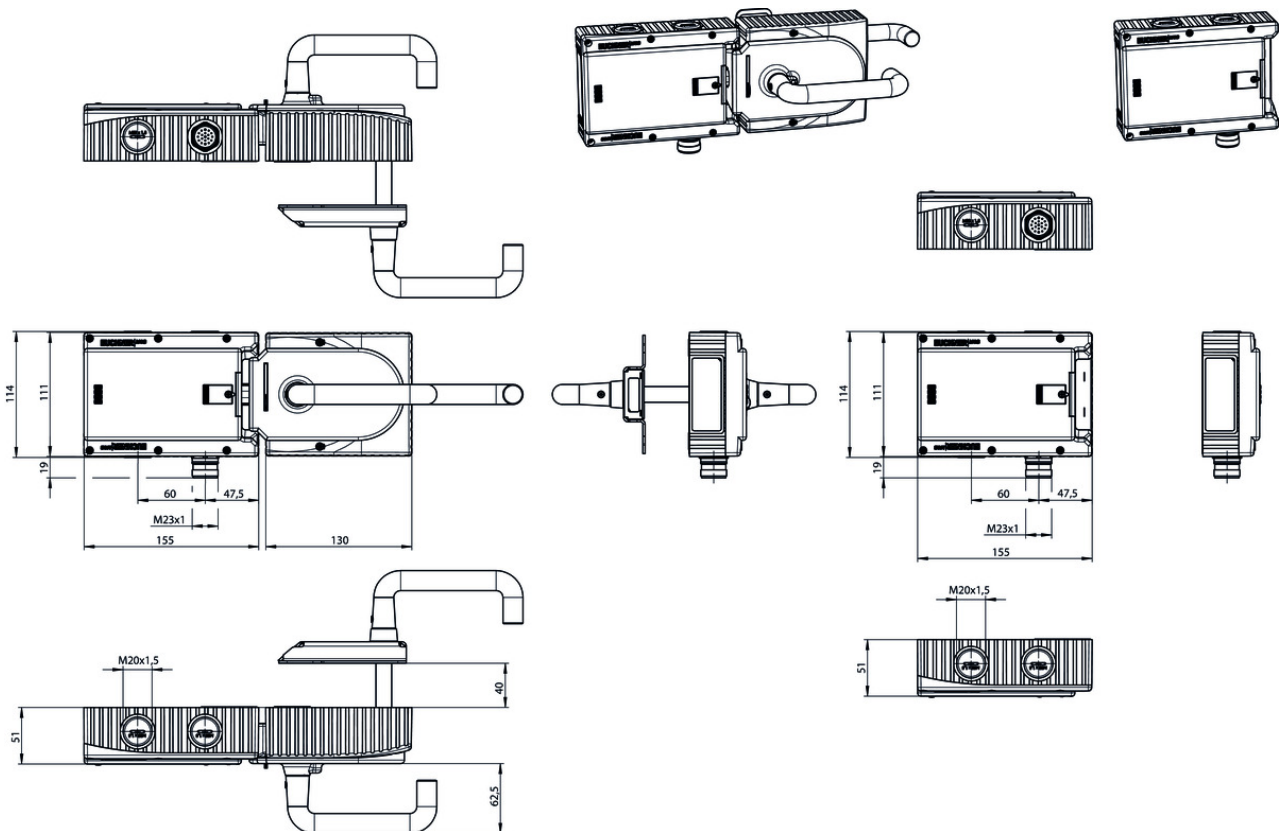

Dimension drawing

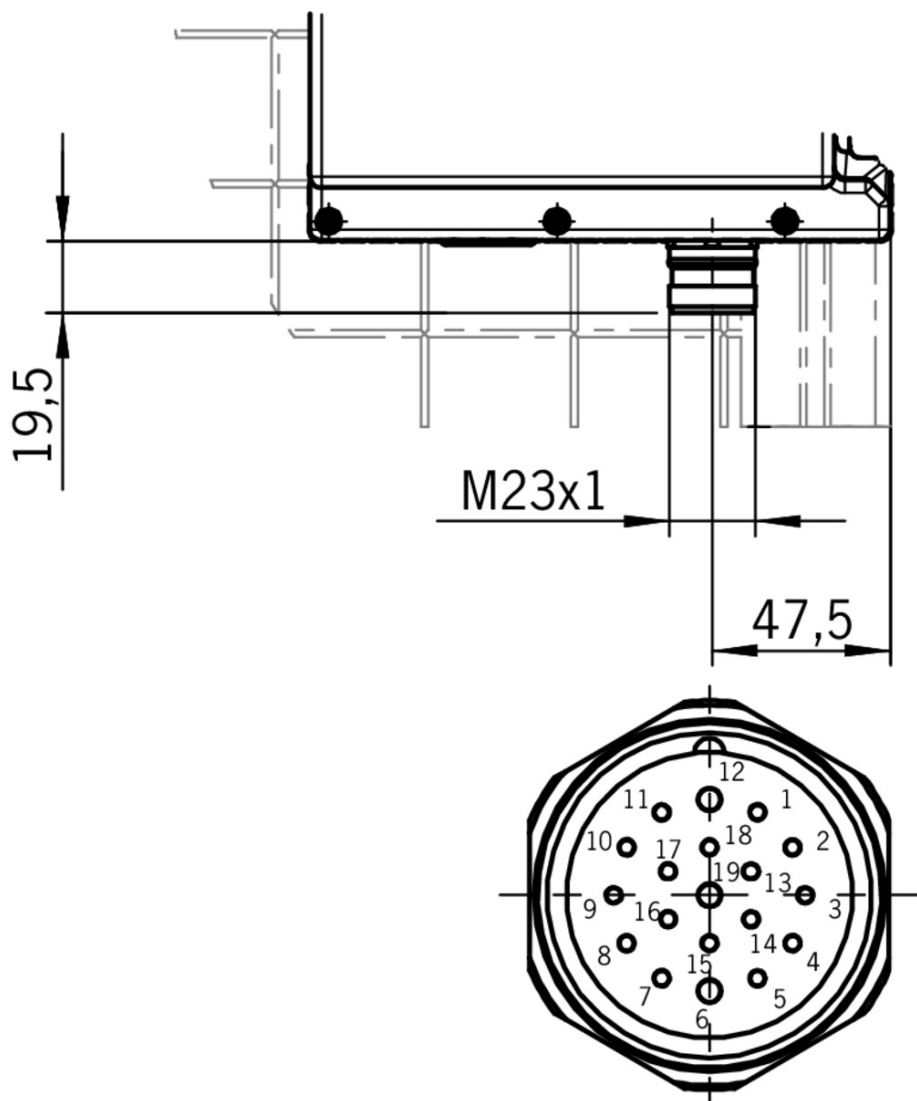

Plug connector RC18

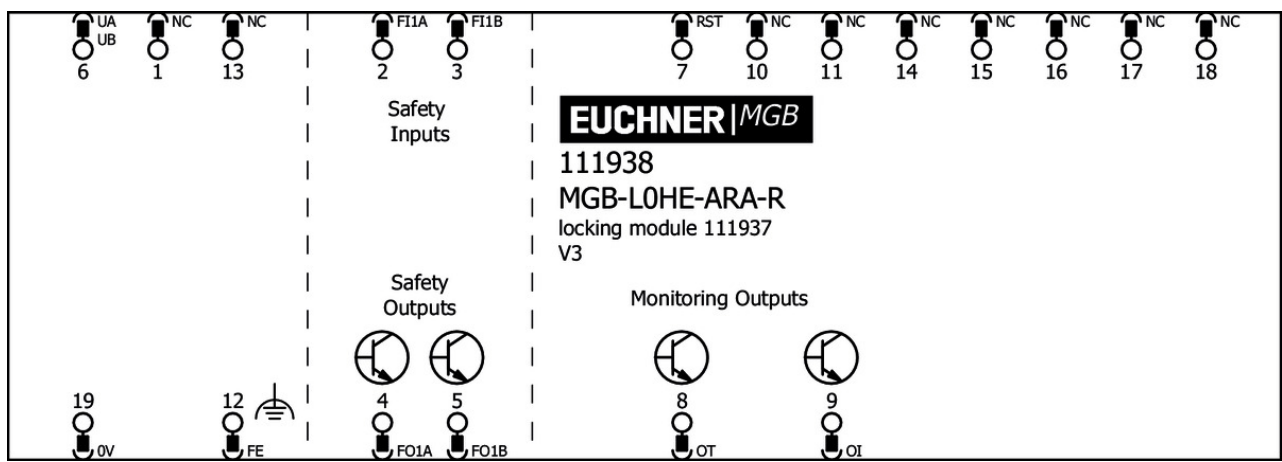

Function expansion

- Door handle for MGB-E...



110276 MGB-A-DOORHANDLE-R1-110276

☑ Features

- › Aluminum, red painted
 - › For mounting on all MGB escape release modules MGB-E
-

☑ Door knob for MGB-E...



114904 MGB-A-DOORKNOB-R1-114904

☑ Features

- › Aluminum, red painted
 - › For mounting on all MGB escape release modules MGB-E
 - › e.g. on sliding doors
-

☑ Door knob for MGB-H...



111460 MGB-A-DOORKNOB-S1-111460

☑ Features

- › Aluminum, silver anodized
 - › For mounting on all MGB handle modules MGB-H... up to V2.0.0
 - › e.g. on sliding doors
-



124030 MGB-A-DOORKNOB-S2-124030

☑ Features

- › Aluminum, silver anodized
 - › For mounting on all MGB handle modules MGB-H... from V3.0.0
 - › e.g. on sliding doors
-

☑ Escape release MGB-E-A...



100465 MGB-E-A-100465

☑ Features

- › Escape release from the danger zone
 - › Door handle signal red
 - › Extended actuation axis for thicker doors (available optionally)
-

☑ Door handle for MGB-H...



123926 MGB-A-DOORHANDLE-S2-123926

☑ Features

- › Aluminum silver anodized
 - › For mounting on all MGB handle modules MGB-H from V3.0.0
-



110277 MGB-A-DOORHANDLE-S1-110277

☑ Features

- › Aluminum silver anodized
 - › For mounting on all MGB handle modules MGB-H up to V2.0.0
-

☑ Extended actuation axis for MGB-E...



106761 AY-ERS-250-106761

Connection material

- Female plug RC18 straight with option C1825



077025 RC18EF-C1825

Features

- › Plug connector M23, straight
 - › Number of pins: 19-pin with screen bonding clamp
-

- Replacement crimp contacts for female connector RC18 with option C1825

094310 CRIMPKONTAKT BUCHSE RCF-C1825

Features

- › 19 crimp sockets
 - › Conductor cross-section 16 x 0.25 - 0.5 mm² and 3 x 0.75 - 1 mm²
 - › For plug connector RC18..C1825
-

- Connection cable with plug connector M23 with option C1825, 1.5m, straight



092761 C-M23F19-19XDIFPU01,5-MA-092761

Features

- › M23 plug connector, 18-pin + PE
 - › Straight plug connector
 - › PUR cable
 - › Cable length 1.5 m
 - › With flying lead
 - › Cores color-coded
-

- Connection cable with plug connector M23 with option C1825, 3m, straight



092816 C-M23F19-19XDIFPU03,0-MA-092816

Features

- › M23 plug connector, 18-pin + PE
 - › Straight plug connector
 - › PUR cable
 - › Cable length 3 m
 - › With flying lead
 - › Cores color-coded
-

- Connection cable with plug connector M23 with option C1825, 6m, straight



077014 C-M23F19-19XDIFPU06,0-MA-077014

Features

- › M23 plug connector, 18-pin + PE
- › Straight plug connector
- › PUR cable
- › Cable length 6 m

- › With flying lead
 - › Cores color-coded
-

▼ Connection cable with plug connector M23 with option C1825, 8m, straight



077015 C-M23F19-19XDIFPU08,0-MA-077015

▼ Features

- › M23 plug connector, 18-pin + PE
 - › Straight plug connector
 - › PUR cable
 - › Cable length 8 m
 - › With flying lead
 - › Cores color-coded
-

▼ Connection cable with plug connector M23 with option C1825, 10m, straight



092898 C-M23F19-19XDIFPU10,0-MA-092898

▼ Features

- › M23 plug connector, 18-pin + PE
 - › Straight plug connector
 - › PUR cable
 - › Cable length 10 m
 - › With flying lead
 - › Cores color-coded
-

▼ Connection cable with plug connector M23 with option C1825, 15m, straight



077016 C-M23F19-19XDIFPU15,0-MA-077016

▼ Features

- › M23 plug connector, 18-pin + PE
 - › Straight plug connector
 - › PUR cable
 - › Cable length 15 m
 - › With flying lead
 - › Cores color-coded
-

▼ Connection cable with plug connector M23 with option C1825, 20m, straight



092726 C-M23F19-19XDIFPU20,0-MA-092726

▼ Features

- › M23 plug connector, 18-pin + PE
 - › Straight plug connector
 - › PUR cable
 - › Cable length 20 m
 - › With flying lead
 - › Cores color-coded
-

▼ Connection cable with plug connector M23 with option C1825, 25m, straight



092727 C-M23F19-19XDIFPU25,0-MA-092727

▼ Features

- › M23 plug connector, 18-pin + PE

- › Straight plug connector
 - › PUR cable
 - › Cable length 25 m
 - › With flying lead
 - › Cores color-coded
-

- ▼ Connection cable with plug connector M23 with option C1825, 30m, straight



095993 C-M23F19-19XDIFPU30,0-MA-095993

▼ Features

- › M23 plug connector, 18-pin + PE
 - › Straight plug connector
 - › PUR cable
 - › Cable length 30 m
 - › With flying lead
 - › Cores color-coded
-

- ▼ Connection cable with plug connector M23 with option C1825, 40m, straight



102490 C-M23F19-19XDIFPU40,0-MA-102490

▼ Features

- › M23 plug connector, 18-pin + PE
 - › Straight plug connector
 - › PUR cable
 - › Cable length 40 m
 - › With flying lead
 - › Cores color-coded
-

Mounting accessories

- ▼ Mounting plate for evaluation modules MGB-L.-AR.-... and MGB-L.-AP.-...



109490 MGB-A-MOUNTINGPLATE-L-109490

▼ Features

- › Easy and quick mounting (only two screws required)
 - › Quick module replacement
 - › Steel, powder-coated
 - › Suitable for doors hinged on the right or left
-

- ▼ Mounting plate for escape release



109492 MGB-A-MOUNTINGPLATE-E-109492

▼ Features

- › Easy and quick mounting (only two screws required)
 - › Quick module replacement
 - › Steel, powder-coated
 - › Suitable for doors hinged on the right or left
-

- ▼ Mounting plate for all MGB handle modules

109491 MGB-A-MOUNTINGPLATE-H-109491



- ✓ Features
 - › Easy and quick mounting (only two screws required)
 - › Quick module replacement
 - › Steel, powder-coated
 - › Suitable for doors hinged on the right or left
-

Spare parts

- ✓ Handle module MGB-H...



111157 MGB-H-AA1A3-R-111157

- ✓ Features
 - › Intelligent bolt tongue
 - › Fold-out lockout mechanism
 - › Second automatically extending lockout mechanism
 - › Door handle
-

- ✓ Interlocking module MGB-L0-ARA..., without control or indicator, RC18



111937 MGB-L0-ARA-AA1A1-S1-R-111937

- ✓ Features
 - › Locking (without guard locking)
 - › Can be connected in series with other AR devices (e.g. CES-AR and CET-AR)
 - › With plug connector RC18
 - › Unicode
-

Miscellaneous accessories

- ✓ Lens set 5 colors



120344 AY-SET-LNS-0001-120344

- ✓ Lens set 6 colors



120378 AY-SET-LNS-0002-120378

- ✓ Lens set labeled



120377 AY-SET-LNS-SY01-120377



125359 AY-SET-LNS-SY02-125359



126158 AY-SET-LNS-SY03-126158

























Instructions

▼ Návod k použití – bezpečnostní systémy MGB-L0...AR-... a MGB-L0...AP-... od V3.0.0

	Doc. no.	Version	Language	Download
Betriebsanleitung MGB-L0...AR-... und MGB-L0...AP-... ab V3.0.0	2112657	13-05/18		 2.9 MB
Mode d'emploi MGB-L0...AR-... et MGB-L0...AP-... à partir de V3.0.0	2112657	13-05/18		 3.0 MB
Manual de instrucciones MGB-L0...AR-... y MGB-L0...AP-... V3.0.0 o superior	2112657	13-05/18		 2.9 MB
Návod k použití – bezpečnostní systémy MGB-L0...AR-... a MGB-L0...AP-... od V3.0.0	2112657	13-05/18		 3.2 MB
Operating Instructions MGB-L0...AR-... and MGB-L0...AP-... from V3.0.0	2112657	13-05/18		 2.9 MB
Istruzioni di impiego per MGB-L0...AR-... e MGB-L0...AP-... da V3.0.0	2112657	13-05/18		 2.9 MB
Instrukcja obsługi MGB-L0...AR-... i MGB-L0...AP-... od V3.0.0	2112657	13-05/18		 3.2 MB
Manual de instruções MGB-L0...AR-... e MGB-L0...AP-... a partir de V3.0.0	2112657	13-05/18		 2.9 MB
Инструкция по эксплуатации MGB-L0...AR-... и MGB-L0...AP-... с V3.0.0	2112657	13-05/18		 3.4 MB
Instruktionsbok MGB-L0...AR-... och MGB-L0...AP-... fr. V3.0.0	2112657	13-05/18		 2.9 MB
操作指示書 安全システム MGB-L0...AR-... および MGB-L0...AP-... V3.0.0以降	2112657	13-05/18		 3.3 MB
使用说明书 安全系统 MGB-L0...AR-...和MGB-L0...AP-... V3.0.0以上	2112657	13-05/18		 3.3 MB







▼ Veiligheidsinformatie (Deel van de handleiding Beveiligingssysteem MGB-AR/MGB-AP) vanaf V3.0.0

Doc. no. Version Language Download

Sicherheitsinformation (Teil der Betriebsanleitung Sicherheitssystem MGB-AR/MGB-AP) ab V3.0.0 Información de seguridad (parte del manual de instrucciones Sistema de seguridad MGB-AR/MGB-AP) V3.0.0 o superior Information de sécurité (partie du mode d'emploi Système de sécurité MGB-AR/MGB-AP) à partir de V3.0.0 Informazioni sulla sicurezza (Parte delle istruzioni di impiego Sistema di sicurezza MGB-AR/MGB-AP) da V3.0.0 Säkerhetsinformation (Del av instruktionsboken Säkerhetssystem MGB-AR/MGB-AP) från V3.0.0 Safety Information (Part of the Operating Instructions Safety System MGB-AR/MGB-AP) from V3.0.0	123151	01-02/15	     	 0.6 MB
Veiligheidsinformatie (Deel van de handleiding Beveiligingssysteem MGB-AR/MGB-AP) vanaf V3.0.0	123151	01-02/15		 0.2 MB
Informação de segurança (Parte do manual de instruções Sistema de segurança MGB-AR/MGB-AP) a partir de V3.0.0	123151	01-02/15		 0.2 MB
Bezpečnostní informace (součást návodu k použití „Bezpečnostní systém MGB-AR/MGB-AP“) od V3.0.0	123151	01-02/15		 0.2 MB
Informacje o bezpieczeństwie (Część instrukcji obsługi System bezpieczeństwa MGB-AR/MGB-AP) od V3.0.0	123151	01-02/15		 0.2 MB
安全信息 (安全系统 MGB-AR/MGB-AP使用说明书的组成部分) V3.0.0以上	123151	01-02/15		 0.3 MB
Информация о безопасности (часть инструкции по эксплуатации Предохранительная система MGB-AR/MGB-AP) с V3.0.0	123151	01-02/15		 0.3 MB
Güvenlik bilgisi (İşletim kılavuzunun parçası emniyet sistemi MGB-AR/MGB-AP) V3.0.0 ve üstü	123151	01-02/15		 0.3 MB
Bezpečnostná informácia (časť návodu na prevádzku Bezpečnostný systém MGB-AR/MGB-AP) od V3.0.0	123151	01-02/15		 0.2 MB
安全情報 MGB-AR/MGB-AP	123151	01-02/15		 0.6 MB

Declaration of conformity

EU-Konformitätserklärung

	Doc. no.	Version	Language	Download
EU-Konformitätserklärung Declaración UE de conformidad Déclaration UE de conformité Dichiarazione di conformità EU declaration of conformity	2123150	08-01/17	    	 0.3 MB

CAD data

CAD data for this item on TraceParts