

ITEM 116215 MGB-LOH-ARA-R-116215

| Description | Technical data | Accessories | Downloads |
|-------------|----------------|-------------|-----------|
|-------------|----------------|-------------|-----------|

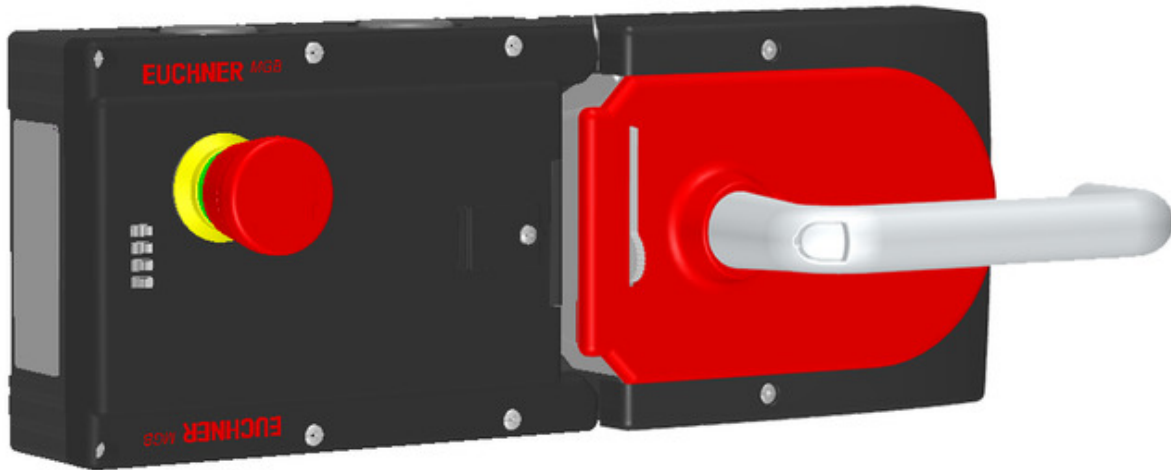

Features

- › Locking (without guard locking)
- › Can be connected in series with other AR devices (e.g. CES-AR and CET-AR)
- › Emergency stop according to ISO 13850
- › With cable entry
- › Unicode

Guard locking type

MGB- The bolt tongue in the handle module is moved into and out of the **LO...** interlocking module by actuating the door handle. The door arm is not locked in the locked position.

Door hinge

A mechanical door stop is permanently integrated into the evaluation module of the MGB. A marking on the stop makes adjustment easier.

LED indicator

The LED indicator indicates all important system and status information.

Monitoring outputs

- OD** ON when the door is closed
- OT** Bolt tongue inserted in the evaluation module
- OI** Diagnostics; there is a fault

Emergency stop device

- S1** 2 positively driven NC contacts and 1 NO contact (e.g. monitoring contact), emergency stop with turn-to-reset, not illuminated

Components included in the set



- 116214 Interlocking module MGB-L0-ARA-AH6A1-M-116214
- ▼ Features



- 111157 Handle module MGB-H-AA1A3-R-111157
- ▼ Features

Dimension drawing

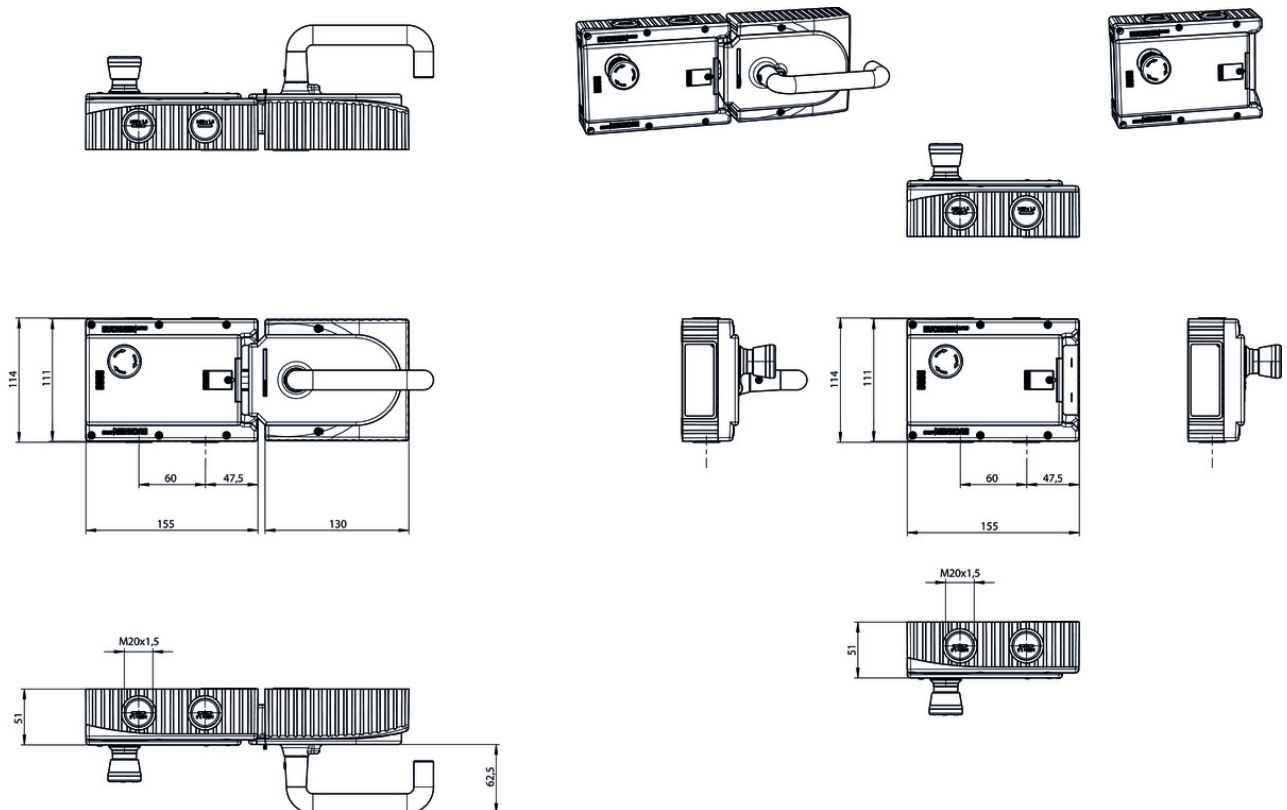

Cable entry

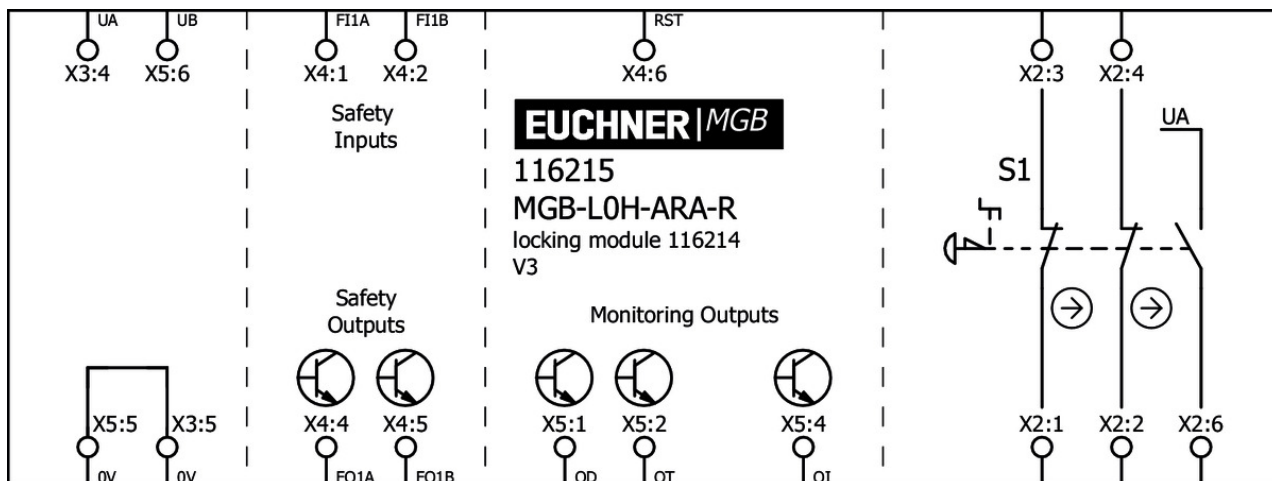

Spare parts

Handle module MGB-H...



111157 MGB-H-AA1A3-R-111157

Features

- › Intelligent bolt tongue
- › Fold-out lockout mechanism
- › Second automatically extending lockout mechanism
- › Door handle

Interlocking module MGB-L0-AR..., with emergency stop



116214 MGB-L0-ARA-AH6A1-M-116214

Features

- › Locking (without guard locking)
- › Can be connected in series with other AR devices (e.g. CES-AR and CET-AR)
- › Emergency stop according to ISO 13850
- › With cable entry
- › Unicode

Function expansion

Escape release MGB-E-A...



100465 MGB-E-A-100465

Features

- › Escape release from the danger zone
- › Door handle signal red
- › Extended actuation axis for thicker doors (available optionally)

Door knob for MGB-H...



111460 MGB-A-DOORKNOB-S1-111460

✓ Features

- › Aluminum, silver anodized
- › For mounting on all MGB handle modules MGB-H... up to V2.0.0
- › e.g. on sliding doors



124030 MGB-A-DOORKNOB-S2-124030

✓ Features

- › Aluminum, silver anodized
- › For mounting on all MGB handle modules MGB-H... from V3.0.0
- › e.g. on sliding doors

✓ Door handle for MGB-H...



110277 MGB-A-DOORHANDLE-S1-110277

✓ Features

- › Aluminum silver anodized
- › For mounting on all MGB handle modules MGB-H up to V2.0.0



123926 MGB-A-DOORHANDLE-S2-123926

✓ Features

- › Aluminum silver anodized
- › For mounting on all MGB handle modules MGB-H from V3.0.0

✓ Emergency unlocking for safety system MGB



112989 MGB-A-EMERGENCYRELEASE-112989

✓ Features

- › Quick emergency unlocking
- › sealable

Mounting accessories

✓ Mounting plate for all MGB handle modules



109491 MGB-A-MOUNTINGPLATE-H-109491

✓ Features

- › Easy and quick mounting (only two screws required)
- › Quick module replacement
- › Steel, powder-coated
- › Suitable for doors hinged on the right or left

✓ Mounting plate for evaluation modules MGB-L.-AR.-... and MGB-L.-AP.-...



109490 MGB-A-MOUNTINGPLATE-L-109490

✓ Features

- › Easy and quick mounting (only two screws required)
- › Quick module replacement
- › Steel, powder-coated
- › Suitable for doors hinged on the right or left

Connection material

▼ Built-in connector RC18

120403 MGB-A-PLUGCONNECTOR-RC18-120403

▼ Features

- › For all MGB with cable entry
-

Miscellaneous accessories

▼ Lens set 6 colors



120378 AY-SET-LNS-0002-120378

▼ Lens set labeled



120377 AY-SET-LNS-SY01-120377



126158 AY-SET-LNS-SY03-126158



125359 AY-SET-LNS-SY02-125359

▼ Lens set 5 colors



120344 AY-SET-LNS-0001-120344

▼ Lens set, three colors



158307 AY-SET-LNS-SY04-158307





Instructions

▼ Návod k použití - bezpečnostní systémy MGB-L0...-AR.-... a MGB-L0...-AP.-... od V3.0.0

| | Doc. no. | Version | Language | Download |
|---|----------|----------|----------|----------|
| Betriebsanleitung MGB-L0...AR.-... und MGB-L0...AP.-... ab V3.0.0 | 2112657 | 13-05/18 | | 2.9 MB |

| | | | | |
|--|---------|----------|--|---|
| Mode d'emploi MGB-L0...AR-... et MGB-L0...AP-... à partir de V3.0.0 | 2112657 | 13-05/18 |  |  3.0 MB |
| Manual de instrucciones MGB-L0...AR-... y MGB-L0...AP-... V3.0.0 o superior | 2112657 | 13-05/18 |  |  2.9 MB |
| Návod k použití – bezpečnostní systémy MGB-L0...-AR-... a MGB-L0...-AP-... od V3.0.0 | 2112657 | 13-05/18 |  |  3.2 MB |
| Operating Instructions MGB-L0...AR-... and MGB-L0...AP-... from V3.0.0 | 2112657 | 13-05/18 |  |  2.9 MB |
| Istruzioni di impiego per MGB-L0...AR-... e MGB-L0...AP-... da V3.0.0 | 2112657 | 13-05/18 |  |  2.9 MB |
| Instrukcja obsługi MGB-L0...AR-... i MGB-L0...AP-... od V3.0.0 | 2112657 | 13-05/18 |  |  3.2 MB |
| Manual de instruções MGB-L0...AR-... e MGB-L0...AP-... a partir de V3.0.0 | 2112657 | 13-05/18 |  |  2.9 MB |
| Инструкция по эксплуатации MGB-L0...AR-... и MGB-L0...AP-... с V3.0.0 | 2112657 | 13-05/18 |  |  3.4 MB |
| Instruktionsbok MGB-L0...AR-... och MGB-L0...AP-... fr. V3.0.0 | 2112657 | 13-05/18 |  |  2.9 MB |
| 操作指示書 安全システム MGB-L0...-AR-... および MGB-L0...-AP-... V3.0.0以降 | 2112657 | 13-05/18 |  |  3.3 MB |
| 使用说明书 安全系统 MGB-L0...-AR-...和MGB-L0...-AP-... V3.0.0以上 | 2112657 | 13-05/18 |  |  3.3 MB |







 **Sicherheitsinformation (Teil der Betriebsanleitung Sicherheitssystem MGB-AR/MGB-AP) ab V3.0.0**

| | Doc. no. | Version | Language | Download |
|---|-----------------|----------------|--|--|
| Sicherheitsinformation (Teil der Betriebsanleitung Sicherheitssystem MGB-AR/MGB-AP) ab V3.0.0 Información de seguridad (parte del manual de instrucciones Sistema de seguridad MGB-AR/MGB-AP) V3.0.0 o superior Information de sécurité (partie du mode d'emploi Système de sécurité MGB-AR/MGB-AP) à partir de V3.0.0 Informazioni sulla sicurezza (Parte delle istruzioni di impiego Sistema di sicurezza MGB-AR/MGB-AP) da V3.0.0 Säkerhetsinformation (Del av instruktionsboken Säkerhetssystem MGB-AR/MGB-AP) från V3.0.0 Safety Information (Part of the Operating Instructions Safety System MGB-AR/MGB-AP) from V3.0.0 | 123151 | 01-02/15 |       |  0.6 MB |
| Veiligheidsinformatie (Deel van de handleiding Beveiligingssysteem MGB-AR/MGB-AP) vanaf V3.0.0 | 123151 | 01-02/15 |  |  0.2 MB |
| Informação de segurança (Parte do manual de instruções Sistema de segurança MGB-AR/MGB-AP) a partir de V3.0.0 | 123151 | 01-02/15 |  |  0.2 MB |
| Bezpečnostní informace (součást návodu k použití „Bezpečnostní systém MGB-AR/MGB-AP“) od V3.0.0 | 123151 | 01-02/15 |  |  0.2 MB |

| | | | | |
|---|--------|----------|---|--|
| Informacje o bezpieczeństwie (Część instrukcji obsługi System bezpieczeństwa MGB-AR/MGB-AP) od V3.0.0 | 123151 | 01-02/15 |  |  0.2 MB |
| Информация о безопасности (часть инструкции по эксплуатации Предохранительная система MGB-AR/MGB-AP) с V3.0.0 | 123151 | 01-02/15 |  |  0.3 MB |
| Bezpečnostná informácia (časť návodu na prevádzku Bezpečnostný systém MGB-AR/MGB-AP) od V3.0.0 | 123151 | 01-02/15 |  |  0.2 MB |
| Güvenlik bilgisi (İşletim kılavuzunun parçası emniyet sistemi MGB-AR/MGB-AP) V3.0.0 ve üstü | 123151 | 01-02/15 |  |  0.3 MB |
| 安全信息 (安全系统 MGB-AR/MGB-AP使用说明书的组成部分) V3.0.0以上 | 123151 | 01-02/15 |  |  0.3 MB |
| 安全情報 MGB-AR/MGB-AP | 123151 | 01-02/15 |  |  0.6 MB |

Declaration of conformity

EU-Konformitätserklärung

| | Doc. no. | Version | Language | Download |
|--|----------|----------|--|--|
| EU-Konformitätserklärung Declaración UE de conformidad Déclaration UE de conformité Dichiarazione di conformità EU declaration of conformity | 2123150 | 08-01/17 |      |  0.3 MB |