

ITEM 117084 MGB-L0H-ARA-R-117084

Description	Technical data	Accessories	Downloads
-------------	----------------	-------------	-----------

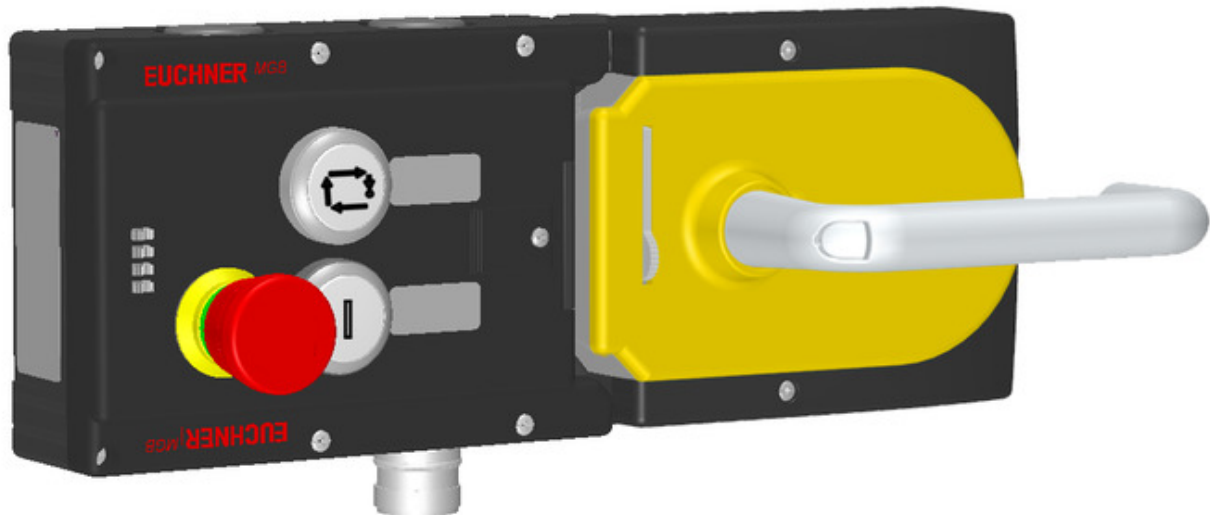

Features

- › Locking (without guard locking)
- › Can be connected in series with other AR devices (e.g. CES-AR and CET-AR)
- › Emergency stop according to ISO 13850
- › 2 pushbuttons (illuminated, wh, wh and printed)
- › With plug connector RC18
- › Unicode

Components included in the set

117083 MGB-L0-ARA-AC4A1-S1-R-117083

Features



111739 Handle module MGB-H-AA1A5-R-111739

Features

Dimension drawing

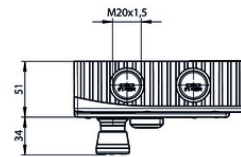
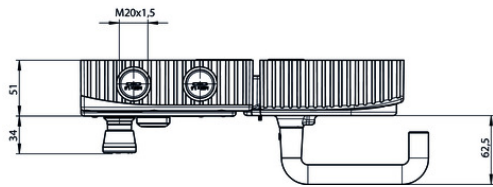
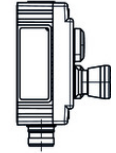
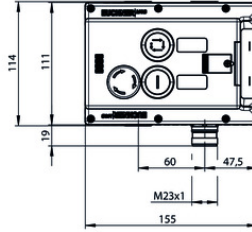
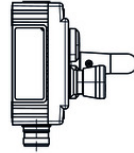
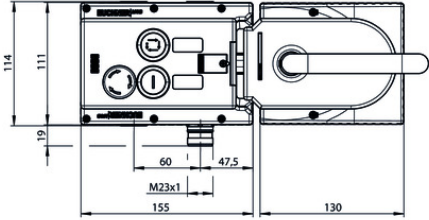
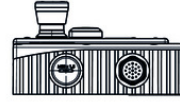
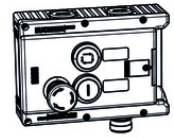
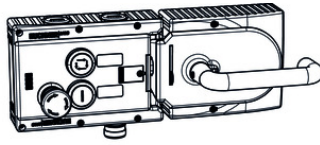
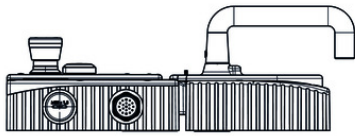

Dimension drawing

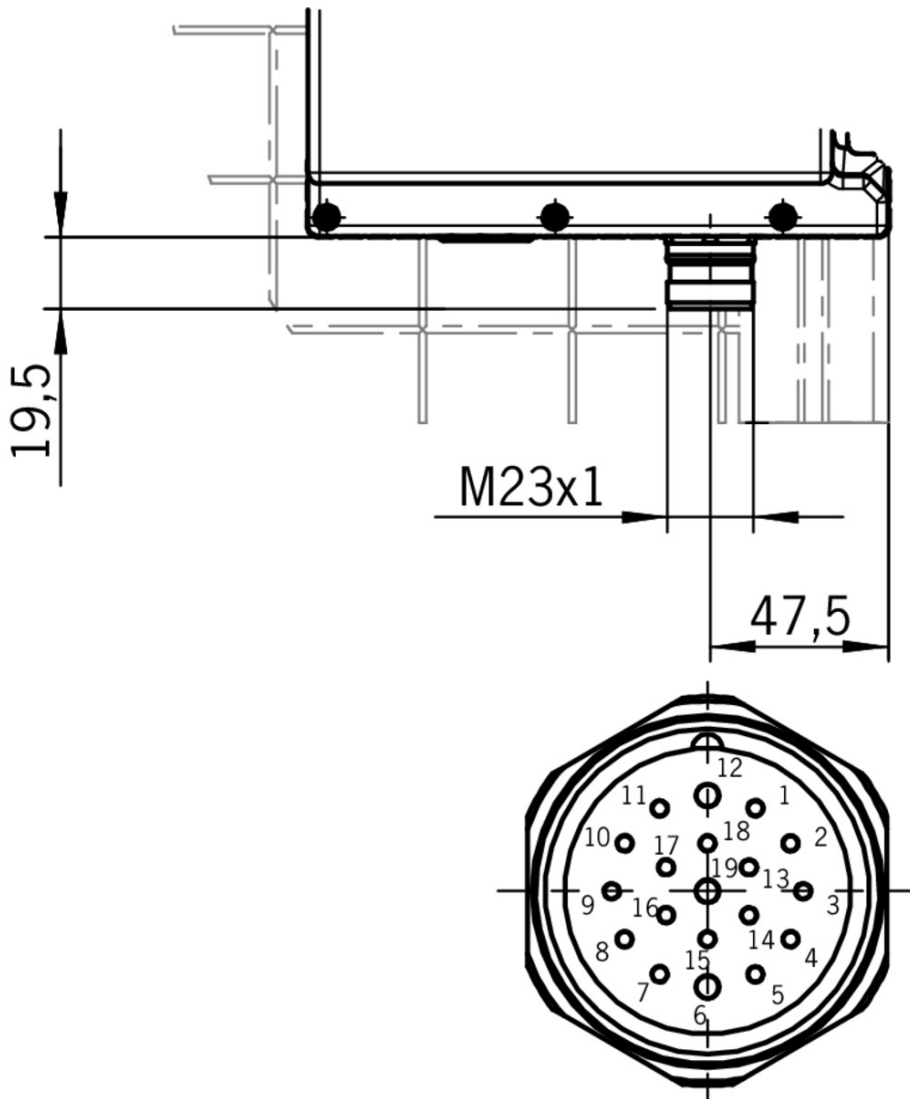

Plug connector RC18

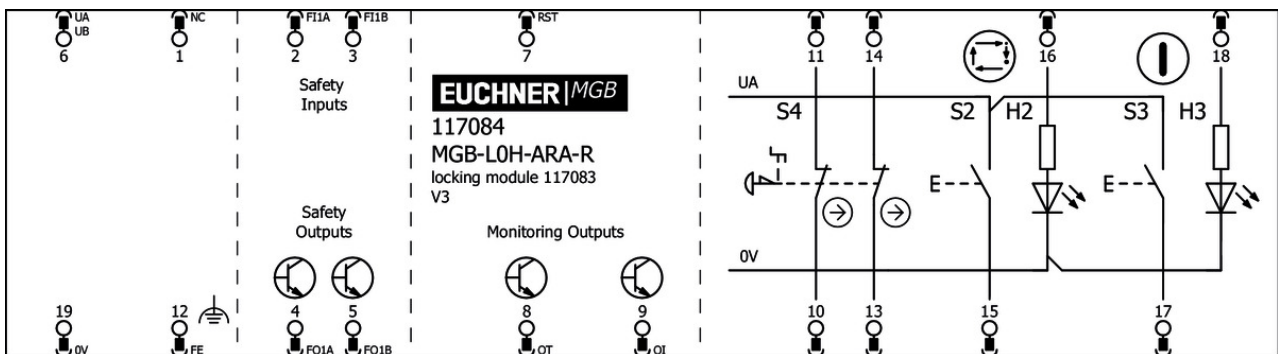

Mounting accessories

- ✓ Mounting plate for all MGB handle modules



109491 MGB-A-MOUNTINGPLATE-H-109491

- ✓ Features

- › Easy and quick mounting (only two screws required)

- › Quick module replacement
 - › Steel, powder-coated
 - › Suitable for doors hinged on the right or left
-

☑ Mounting plate for evaluation modules MGB-L.-AR.-... and MGB-L.-AP.-...



109490 MGB-A-MOUNTINGPLATE-L-109490

☑ Features

- › Easy and quick mounting (only two screws required)
 - › Quick module replacement
 - › Steel, powder-coated
 - › Suitable for doors hinged on the right or left
-

Function expansion

☑ Emergency unlocking for safety system MGB



112989 MGB-A-EMERGENCYRELEASE-112989

☑ Features

- › Quick emergency unlocking
 - › sealable
-

☑ Door knob for MGB-H...



111460 MGB-A-DOORKNOB-S1-111460

☑ Features

- › Aluminum, silver anodized
 - › For mounting on all MGB handle modules MGB-H... up to V2.0.0
 - › e.g. on sliding doors
-



124030 MGB-A-DOORKNOB-S2-124030

☑ Features

- › Aluminum, silver anodized
 - › For mounting on all MGB handle modules MGB-H... from V3.0.0
 - › e.g. on sliding doors
-

☑ Escape release MGB-E-A...



100465 MGB-E-A-100465

☑ Features

- › Escape release from the danger zone
 - › Door handle signal red
 - › Extended actuation axis for thicker doors (available optionally)
-

☑ Door handle for MGB-H...



110277 MGB-A-DOORHANDLE-S1-110277

☑ Features

- › Aluminum silver anodized
- › For mounting on all MGB handle modules MGB-H up to V2.0.0



123926 MGB-A-DOORHANDLE-S2-123926

▼ Features

- › Aluminum silver anodized
- › For mounting on all MGB handle modules MGB-H from V3.0.0

Spare parts

▼ Handle module MGB-H-..., yellow



111739 MGB-H-AA1A5-R-111739

▼ Features

- › Intelligent bolt tongue
- › Lockout bar
- › Door handle

Connection material

▼ Female plug RC18 straight with option C1825



077025 RC18EF-C1825

▼ Features

- › Plug connector M23, straight
- › Number of pins: 19-pin with screen bonding clamp

▼ Replacement crimp contacts for female connector RC18 with option C1825

094310 CRIMPKONTAKT BUCHSE RCF-C1825

▼ Features

- › 19 crimp sockets
- › Conductor cross-section 16 x 0.25 - 0.5 mm² and 3 x 0.75 - 1 mm²
- › For plug connector RC18..C1825

▼ Connection cable with plug connector M23 with option C1825, 1.5m, straight



092761 C-M23F19-19XDIFPU01,5-MA-092761

▼ Features

- › M23 plug connector, 18-pin + PE
- › Straight plug connector
- › PUR cable
- › Cable length 1.5 m
- › With flying lead
- › Cores color-coded

▼ Connection cable with plug connector M23 with option C1825, 3m, straight



092816 C-M23F19-19XDIFPU03,0-MA-092816

▼ Features

- › M23 plug connector, 18-pin + PE
 - › Straight plug connector
 - › PUR cable
 - › Cable length 3 m
 - › With flying lead
 - › Cores color-coded
-

▼ Connection cable with plug connector M23 with option C1825, 6m, straight



077014 C-M23F19-19XDIFPU06,0-MA-077014

▼ Features

- › M23 plug connector, 18-pin + PE
 - › Straight plug connector
 - › PUR cable
 - › Cable length 6 m
 - › With flying lead
 - › Cores color-coded
-

▼ Connection cable with plug connector M23 with option C1825, 8m, straight



077015 C-M23F19-19XDIFPU08,0-MA-077015

▼ Features

- › M23 plug connector, 18-pin + PE
 - › Straight plug connector
 - › PUR cable
 - › Cable length 8 m
 - › With flying lead
 - › Cores color-coded
-

▼ Connection cable with plug connector M23 with option C1825, 10m, straight



092898 C-M23F19-19XDIFPU10,0-MA-092898

▼ Features

- › M23 plug connector, 18-pin + PE
 - › Straight plug connector
 - › PUR cable
 - › Cable length 10 m
 - › With flying lead
 - › Cores color-coded
-

▼ Connection cable with plug connector M23 with option C1825, 15m, straight



077016 C-M23F19-19XDIFPU15,0-MA-077016

▼ Features

- › M23 plug connector, 18-pin + PE
 - › Straight plug connector
 - › PUR cable
 - › Cable length 15 m
 - › With flying lead
 - › Cores color-coded
-

▼ Connection cable with plug connector M23 with option C1825, 20m, straight



092726 C-M23F19-19XDIFPU20,0-MA-092726

▼ Features

- › M23 plug connector, 18-pin + PE
 - › Straight plug connector
 - › PUR cable
 - › Cable length 20 m
 - › With flying lead
 - › Cores color-coded
-

▼ Connection cable with plug connector M23 with option C1825, 25m, straight



092727 C-M23F19-19XDIFPU25,0-MA-092727

▼ Features

- › M23 plug connector, 18-pin + PE
 - › Straight plug connector
 - › PUR cable
 - › Cable length 25 m
 - › With flying lead
 - › Cores color-coded
-

▼ Connection cable with plug connector M23 with option C1825, 30m, straight



095993 C-M23F19-19XDIFPU30,0-MA-095993

▼ Features

- › M23 plug connector, 18-pin + PE
 - › Straight plug connector
 - › PUR cable
 - › Cable length 30 m
 - › With flying lead
 - › Cores color-coded
-

▼ Connection cable with plug connector M23 with option C1825, 40m, straight



102490 C-M23F19-19XDIFPU40,0-MA-102490

▼ Features

- › M23 plug connector, 18-pin + PE
 - › Straight plug connector
 - › PUR cable
 - › Cable length 40 m
 - › With flying lead
 - › Cores color-coded
-

Miscellaneous accessories

▼ Lens set 5 colors



120344 AY-SET-LNS-0001-120344

▼ Lens set 6 colors



120378 AY-SET-LNS-0002-120378

▼ Lens set labeled



120377 AY-SET-LNS-SY01-120377



125359 AY-SET-LNS-SY02-125359



126158 AY-SET-LNS-SY03-126158

▼ Lens set, three colors







158307 AY-SET-LNS-SY04-158307

























Instructions

▼ Návod k použití – bezpečnostní systémy MGB-L0...AR.-... a MGB-L0...AP.-... od V3.0.0

	Doc. no.	Version	Language	Download
Betriebsanleitung MGB-L0...AR.-... und MGB-L0...AP.-... ab V3.0.0	2112657	13-05/18		2.9 MB
Mode d'emploi MGB-L0...AR.-... et MGB-L0...AP.-... à partir de V3.0.0	2112657	13-05/18		3.0 MB
Manual de instrucciones MGB-L0...AR.-... y MGB-L0...AP.-... V3.0.0 o superior	2112657	13-05/18		2.9 MB
Návod k použití – bezpečnostní systémy MGB-L0...AR.-... a MGB-L0...AP.-... od V3.0.0	2112657	13-05/18		3.2 MB
Operating Instructions MGB-L0...AR.-... and MGB-L0...AP.-... from V3.0.0	2112657	13-05/18		2.9 MB
Istruzioni di impiego per MGB-L0...AR.-... e MGB-L0...AP.-... da V3.0.0	2112657	13-05/18		2.9 MB
Instrukcja obsługi MGB-L0...AR.-... i MGB-L0...AP.-... od V3.0.0	2112657	13-05/18		3.2 MB
Manual de instruções MGB-L0...AR.-... e MGB-L0...AP.-... a partir de V3.0.0	2112657	13-05/18		2.9 MB
Инструкция по эксплуатации MGB-L0...AR.-... и MGB-L0...AP.-... с V3.0.0	2112657	13-05/18		3.4 MB
Instruktionsbok MGB-L0...AR.-... och MGB-L0...AP.-... fr. V3.0.0	2112657	13-05/18		2.9 MB





操作指示書 安全システム MGB-L0...-AR.... および MGB-L0...-AP.... V3.0.0以降	2112657	13-05/18		 3.3 MB
使用说明书 安全系统 MGB-L0...-AR....和MGB-L0...-AP.... V3.0.0以上	2112657	13-05/18		 3.3 MB

 **Sicherheitsinformation (Teil der Betriebsanleitung Sicherheitssystem MGB-AR/MGB-AP) ab V3.0.0**

	Doc. no.	Version	Language	Download
Sicherheitsinformation (Teil der Betriebsanleitung Sicherheitssystem MGB-AR/MGB-AP) ab V3.0.0 Información de seguridad (parte del manual de instrucciones Sistema de seguridad MGB-AR/MGB-AP) V3.0.0 o superior Information de sécurité (partie du mode d'emploi Système de sécurité MGB-AR/MGB-AP) à partir de V3.0.0 Informazioni sulla sicurezza (Parte delle istruzioni di impiego Sistema di sicurezza MGB-AR/MGB-AP) da V3.0.0 Säkerhetsinformation (Del av instruktionsboken Säkerhetssystem MGB-AR/MGB-AP) från V3.0.0 Safety Information (Part of the Operating Instructions Safety System MGB-AR/MGB-AP) from V3.0.0	123151	01-02/15	     	 0.6 MB
Veiligheidsinformatie (Deel van de handleiding Beveiligingssysteem MGB-AR/MGB-AP) vanaf V3.0.0	123151	01-02/15		 0.2 MB
Informação de segurança (Parte do manual de instruções Sistema de segurança MGB-AR/MGB-AP) a partir de V3.0.0	123151	01-02/15		 0.2 MB
Bezpečnostní informace (součást návodu k použití „Bezpečnostní systém MGB-AR/MGB-AP“) od V3.0.0	123151	01-02/15		 0.2 MB
Informacje o bezpieczeństwie (Część instrukcji obsługi System bezpieczeństwa MGB-AR/MGB-AP) od V3.0.0	123151	01-02/15		 0.2 MB
Информация о безопасности (часть инструкции по эксплуатации Предохранительная система MGB-AR/MGB-AP) с V3.0.0	123151	01-02/15		 0.3 MB
Bezpečnostná informácia (časť návodu na prevádzku Bezpečnostný systém MGB-AR/MGB-AP) od V3.0.0	123151	01-02/15		 0.2 MB
Güvenlik bilgisi (İşletim kılavuzunun parçası emniyet sistemi MGB-AR/MGB-AP) V3.0.0 ve üstü	123151	01-02/15		 0.3 MB
安全信息 (安全系统 MGB-AR/MGB-AP使用说明书的组成部分) V3.0.0以上	123151	01-02/15		 0.3 MB
安全情報 MGB-AR/MGB-AP	123151	01-02/15		 0.6 MB

Declaration of conformity

 EU-Konformitätserklärung

	Doc. no.	Version	Language	Download
EU-Konformitätserklärung	2123150	08-01/17		 0.3 MB
Declaración UE de conformidad				
Déclaration UE de conformité				
Dichiarazione di conformità				
EU declaration of conformity			