

## ITEM 121022 MGB-L1-ARA-BL3A1-M-R-121022

Description	Technical data	Accessories	Downloads
-------------	----------------	-------------	-----------

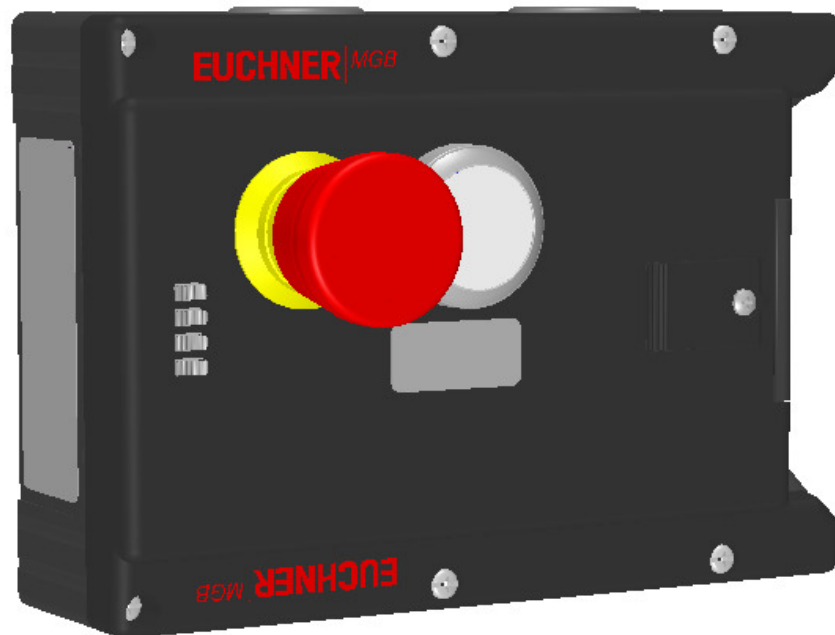

### Features

- › Guard locking with guard lock monitoring (switched off)
- › Can be connected in series with other AR devices (e.g. CES-AR and CET-AR)
- › Emergency stop according to ISO 13850
- › 1 pushbuttons (illuminated)
- › Lens set, 6 pcs.
- › Incl. adhesive labels
- › With cable entry
- › Unicode

### Guard locking type

**MGB-** The locking arm is held in the locked position by spring force and is  
**L1...** unlocked by solenoid force (closed-circuit current principle, mechanically locked).

### Guard lock monitoring switched off

As the default setting on delivery, guard lock monitoring is switched off via the internal DIP switches on these evaluation modules. Consequently, guard locking is suitable only for process protection. Safety outputs FO1A and FO1B do not depend on the state of guard locking.

---

## Door hinge

A mechanical door stop is permanently integrated into the evaluation module of the MGB. A marking on the stop makes adjustment easier.

---

## LED indicator

The LED indicator indicates all important system and status information.

---

## Monitoring outputs

- OD** ON when the door is closed
  - OT** Bolt tongue inserted in the evaluation module
  - OL** Guard locking solenoid in locked position
  - OI** Diagnostics; there is a fault
- 

## Emergency stop device

- S1** 2 positively driven NC contacts and 1 NO contact (e.g. monitoring contact), emergency stop with turn-to-reset, not illuminated
- 

## Pushbutton

- S2** 1 NO contact, illuminated
- 

## Lens set

The color of the pushbutton can be selected using the lens set included (5 colors). Item no.: 120344 (see Accessories)

---

## Adhesive labels

Devices with adhesive labels have pre-formed recesses. The adhesive labels enclosed (standard size 12.5 x 27 mm) can be affixed in these recesses.

## Approvals



## Mechanical values and environment

Housing material	Reinforced plastic; die-cast zinc nickel-plated, stainless steel
Weight	Net 0,75 kg
Ambient temperature	At $U_B = 24V DC$ -20 ... 55 °C

Degree of protection	IP65
Mechanical life	
	$1 \times 10^6$
In case of use as door stop, and 1 Joule impact energy	$0,1 \times 10^6$
Installation position	Door hinge DIN right
Switching frequency	0,25 Hz
Connection	Cable entries M20x1.5
Guard locking principle	Closed-circuit current principle
Locking force $F_{Zh}$	2000 N

### Electrical connection ratings

Utilization category according to EN 60947-5-2	
DC-13	24V 200mA <sup>[1]</sup>
Rated insulation voltage $U_i$	30 V
Rated impulse withstand voltage $U_{imp}$	1,5 kV
Degree of contamination (external, according to EN 60947-1)	3
Connection cross-section	
(Rigid/flexible)	0,13 ... 1,5 mm <sup>2</sup>
(Rigid/flexible) with cable end sleeve according to DIN 46 228/1	0,25 ... 1,5 mm <sup>2</sup>
(Rigid/flexible) with cable end sleeve with collar according to DIN 46 228/1	0,25 ... 0,75 mm <sup>2</sup>
Safety class	III
Discrepancy time	
Between FO1A and FO1B	max.10 ms
Risk time according to EN 60947-5-3	max.350 ms
Transponder coding	Unicode
	<b>Power supply <math>U_B</math></b>
Operating voltage DC	
$U_B$	24 V DC -15% ... 10% <sup>[2]</sup>
Current consumption	
$I_{UB}$	max.80 mA <sup>[3]</sup>
	<b>Power supply <math>U_A</math></b>
Operating voltage DC	
$U_A$	24 V DC -15% ... 10% <sup>[4]</sup>
Current consumption	
$I_{UA}$	max.375 mA <sup>[5]</sup>
	<b>Safety outputs FO1A, FO1B</b>
Test pulses	max.1 ms
Test-pulse interval	min.100 ms
Type of output	Semiconductor outputs, p-switching, short circuit-proof
Output voltage	
$U_{FO1A} / U_{FO1B} \text{ HIGH}$	$U_B - 2V \dots U_B \text{ V DC}$ <sup>[6]</sup>

$U_{FO1A} / U_{FO1B}$ LOW	0 ... 1 V DC
Output current	
Per safety output FO1A / FO1B	1 ... 200 mA
	<b>Monitoring outputs OD, OT, OL, OI</b>
Type of output	Semiconductor outputs, p-switching, short circuit-proof
Output voltage	$U_A - 2V \dots U_A$ V DC [7]
Output current	max.50 mA
	<b>Controls and indicators</b>
Switching voltage	$U_A$ V
Switching current	1 ... 10 mA
Breaking capacity	max.0,25 W
Power supply LED	24 V DC
	<b>Emergency stop</b>
Switching voltage	5 ... 24 V
Switching current	1 ... 100 mA
Breaking capacity	max.0,25 W
Power supply LED	24 V DC
	<b>Solenoid control input IMP1, IMP2, IMM</b>
Test pulses	max.5 ms
Test-pulse interval	min.100 ms

## Controls and indicators

Assignment diagram	L1
Control/indicator	
	<b>Position 1</b>
Version	Emergency stop
Special features	With auxiliary contact
Color	
Switching element	2 pos. driven NC + 1NO
Slide-in label	
Control/indicator	
	<b>Position 2</b>
Version	Illuminated push buttons
Special features	
Color	
Switching element	1NO
Slide-in label	

## Miscellaneous

Additional feature	Incl. cover set ID. No. 120344
Product version number	V3.0.3
Slide-in label	1 pc. without marking

**Reliability values acc. to EN ISO 13849-1**

	<b>Monitoring of guard locking and the safety guard position</b>
Category	4
Performance Level	PL e
PFH <sub>D</sub>	$3.7 \times 10^{-9}$
	<b>Control of the guard locking</b>
Category	4
Performance Level	PL e
PFH <sub>D</sub>	$2.8 \times 10^{-9}$
	<b>Emergency stop</b>
B10 <sub>D</sub>	Emergency stop $0,065 \times 10^6$
<hr/>	
Mission time	20 y

[1] Caution: outputs must be protected with a free-wheeling diode in case of inductive loads.

[2, 4] (Reverse polarity protected, regulated, residual ripple <5%, PELV)

[3] (no load on outputs)

[5] (With energized guard locking solenoid and unloaded outputs OD, OT, OL, OI, +20 °C, 24V)

[6, 7] Value at a switching current of 50mA without taking into account the cable lengths

**Dimension drawing**

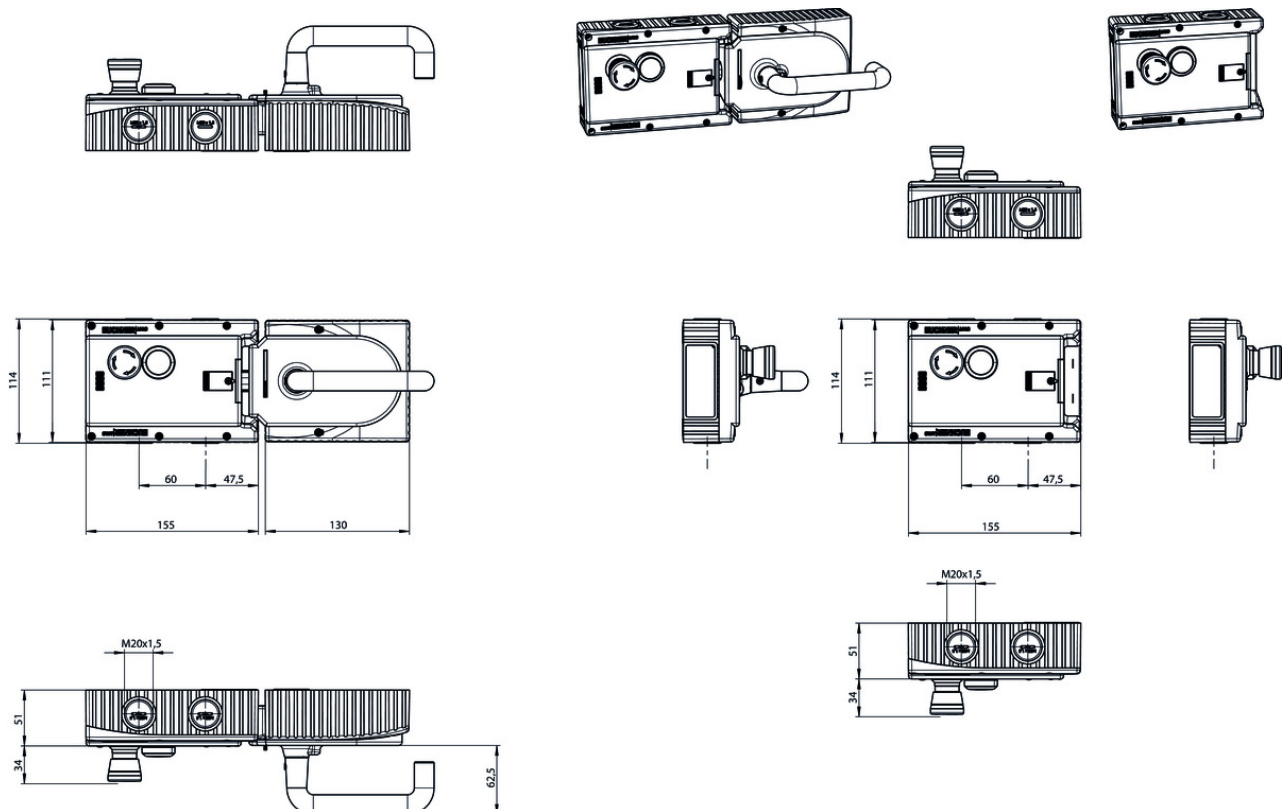

## Cable entry

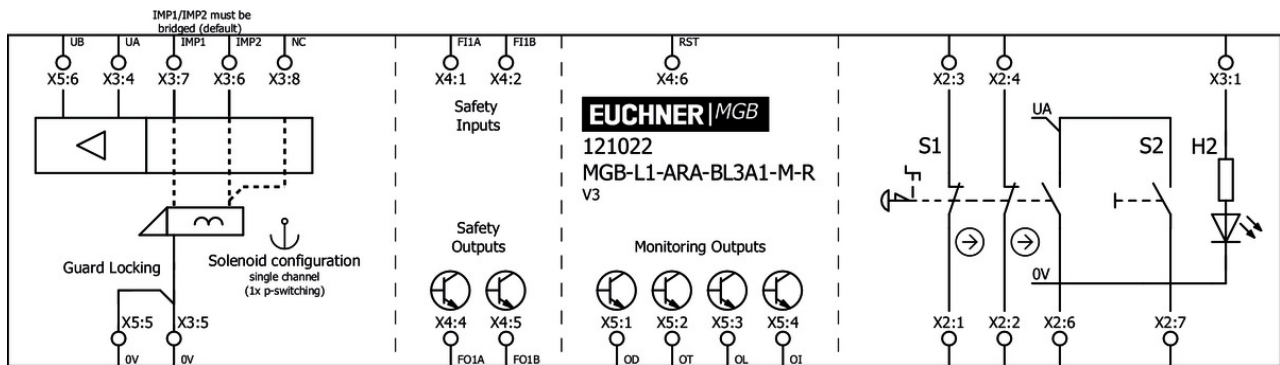

## Miscellaneous accessories

### ▼ Lens set 5 colors



**120344** AY-SET-LNS-0001-120344

### ▼ Lens set 6 colors



**120378** AY-SET-LNS-0002-120378

### ▼ Lens set labeled



**120377** AY-SET-LNS-SY01-120377



**125359** AY-SET-LNS-SY02-125359



**126158** AY-SET-LNS-SY03-126158

### ▼ Adhesive labels

**114529** MGB-A-PLATESET-NN01-114529

#### ▼ Features

- › Adhesive labels suitable for MGB evaluation modules, bus modules and control modules
- › silver, blank
- › Packaging unit = 10 pcs.

### ▼ Lens set, three colors



**158307** AY-SET-LNS-SY04-158307

## Connection material

### ▼ Built-in connector RC18

**120403** MGB-A-PLUGCONNECTOR-RC18-120403

#### ▼ Features

- › For all MGB with cable entry

### ▼ Cable glands M20x1.5



**086233** EKPM20/06 086233

## Mounting accessories

### ▼ Mounting plate for evaluation modules MGB-L.-AR.-... and MGB-L.-AP.-...



**109490** MGB-A-MOUNTINGPLATE-L-109490

#### ▼ Features

- › Easy and quick mounting (only two screws required)
- › Quick module replacement
- › Steel, powder-coated
- › Suitable for doors hinged on the right or left

## Function expansion

### ▼ Emergency unlocking for safety system MGB



**112989** MGB-A-EMERGENCYRELEASE-112989

























#### ▼ Features

- › Quick emergency unlocking
- › sealable

## Instructions

### ▼ Návod k použití – bezpečnostní systémy MGB-L1...AR.-... / MGB-L2...AR.-... a MGB-L1...AP.-... / MGB-L2...AP.-... od V3.0.0

























	Doc. no.	Version	Language	Download
Betriebsanleitung MGB-L1...AR.-... / MGB-L2...AR.-... und MGB-L1...AP.-... / MGB-L2...AP.-... ab V3.0.0	2119167	04-05/18		3.7 MB
Mode d'emploi MGB-L1...AR.-... / MGB-L2...AR.-... et MGB-L1...AP.-... / MGB-L2...AP.-... à partir de V3.0.0	2119167	04-05/18		3.7 MB

Manual de instrucciones MGB-L1...AR.-... / MGB-L2...AR.-... y MGB-L1...AP.-... / MGB-L2...AP.-... V3.0.0 o superior	2119167	04-05/18		 3.7 MB
Návod k použití – bezpečnostní systémy MGB-L1...AR.-... / MGB-L2...AR.-... a MGB-L1...AP.-... / MGB-L2...AP.-... od V3.0.0	2119167	04-05/18		 4.0 MB
Operating Instructions MGB-L1...AR.-... / MGB-L2...AR.-... and MGB-L1...AP.-... / MGB-L2...AP.-... from V3.0.0	2119167	04-05/18		 3.7 MB
Istruzioni di impiego MGB-L1...AR.-... / MGB-L2...AR.-... und MGB-L1...AP.-... / MGB-L2...AP.-... da V3.0.0	2119167	04-05/18		 3.7 MB
Handleiding MGB-L1...AR.-... / MGB-L2...AR.-... en MGB-L1...AP.-... / MGB-L2...AP.-... vanaf V3.0.0	2119167	04-05/18		 3.7 MB
Instrukcja obsługi MGB-L1...AR.-... / MGB-L2...AR.-... i MGB-L1...AP.-... / MGB-L2...AP.-... od V3.0.0	2119167	04-05/18		 4.0 MB
Manual de instruções MGB-L1...AR.-... / MGB-L2...AR.-... e MGB-L1...AP.-... / MGB-L2...AP.-... a partir de V3.0.0	2119167	04-05/18		 3.7 MB
Инструкция по эксплуатации MGB-L1...AR.-... / MGB-L2...AR.-... и MGB-L1...AP.-... / MGB-L2...AP.-... с V3.0.0	2119167	04-05/18		 4.2 MB
Návod na prevádzku Bezpečnostné systémy MGB-L1...AR.-... / MGB-L2...AR.-... a MGB-L1...AP.-... / MGB-L2...AP.-... od V3.0.0	2119167	04-05/18		 4.0 MB
Instruktionsbok MGB-L1...AR.-... / MGB-L2...AR.-... och MGB-L1...AP.-... / MGB-L2...AP.-... fr. V3.0.0	2119167	04-05/18		 3.7 MB
İşletim kılavuzu MGB-L1...AR.-... / MGB-L2...AR.-... ve MGB-L1...AP.-... / MGB-L2...AP.-... itibaren V3.0.0	2119167	04-05/18		 4.1 MB
操作指示書 安全システム MGB-L1...-AR.-... / MGB-L2...-AR.-... および MGB-L1...-AP.-... / MGB-L2...-AP.-... V3.0.0以降	2119167	04-05/18		 4.1 MB
使用说明书 安全系统 MGB-L1...-AR.-... / MGB-L2...-AR.-...和MGB-L1...-AP.-... / MGB-L2...-AP.-... V3.0.0以上	2119167	04-05/18		 4.1 MB

 Sicherheitsinformation (Teil der Betriebsanleitung Sicherheitssystem MGB-AR/MGB-AP) ab V3.0.0







**Doc. no.**   **Version**   **Language**   **Download**



Sicherheitsinformation (Teil der Betriebsanleitung Sicherheitssystem MGB-AR/MGB-AP) ab V3.0.0 Información de seguridad (parte del manual de instrucciones Sistema de seguridad MGB-AR/MGB-AP) V3.0.0 o superior Information de sécurité (partie du mode d'emploi Système de sécurité MGB-AR/MGB-AP) à partir de V3.0.0 Informazioni sulla sicurezza (Parte delle istruzioni di impiego Sistema di sicurezza MGB-AR/MGB-AP) da V3.0.0 Säkerhetsinformation (Del av instruktionsboken Säkerhetssystem MGB-AR/MGB-AP) från V3.0.0 Safety Information (Part of the Operating Instructions Safety System MGB-AR/MGB-AP) from V3.0.0	123151	01-02/15	     	 0.6 MB
Informacje o bezpieczeństwie (Część instrukcji obsługi System bezpieczeństwa MGB-AR/MGB-AP) od V3.0.0	123151	01-02/15		 0.2 MB
Bezpečnostní informace (součást návodu k použití „Bezpečnostní systém MGB-AR/MGB-AP“) od V3.0.0	123151	01-02/15		 0.2 MB
Veiligheidsinformatie (Deel van de handleiding Beveiligingssysteem MGB-AR/MGB-AP) vanaf V3.0.0	123151	01-02/15		 0.2 MB
Informação de segurança (Parte do manual de instruções Sistema de segurança MGB-AR/MGB-AP) a partir de V3.0.0	123151	01-02/15		 0.2 MB
Информация о безопасности (часть инструкции по эксплуатации Предохранительная система MGB-AR/MGB-AP) с V3.0.0	123151	01-02/15		 0.3 MB
Bezpečnostná informácia (časť návodu na prevádzku Bezpečnostný systém MGB-AR/MGB-AP) od V3.0.0	123151	01-02/15		 0.2 MB
Güvenlik bilgisi (İşletim kılavuzunun parçası emniyet sistemi MGB-AR/MGB-AP) V3.0.0 ve üstü	123151	01-02/15		 0.3 MB
安全信息 (安全系统 MGB-AR/MGB-AP使用说明书的组成部分) V3.0.0以上	123151	01-02/15		 0.3 MB
安全情報 MGB-AR/MGB-AP	123151	01-02/15		 0.6 MB

## Declaration of conformity

### EU-Konformitätserklärung

	Doc. no.	Version	Language	Download
EU-Konformitätserklärung Declaración UE de conformidad Déclaration UE de conformité Dichiarazione di conformità EU declaration of conformity	2123150	08-01/17	    	 0.3 MB