

ITEM 121237 MGB-L2-ARA-AM3A1-M-R-121237

Description	Technical data	Accessories	Downloads
-------------	----------------	-------------	-----------

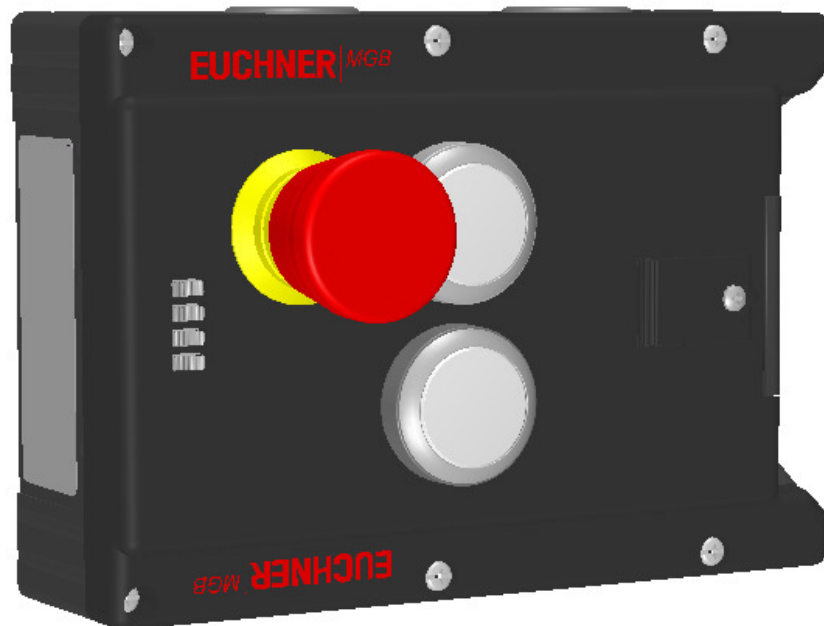

Features

- › Guard locking with guard lock monitoring
- › Can be connected in series with other AR devices (e.g. CES-AR and CET-AR)
- › Emergency stop according to ISO 13850
- › 2 pushbuttons (illuminated)
- › With lens set, 6 pcs.
- › With cable entry
- › Unicode

Guard locking type

MGB- The locking arm is kept in locked position by solenoid force and
L2... unlocked by spring force when the solenoid is switched off (open-circuit current principle, electrically locked).

Door hinge

A mechanical door stop is permanently integrated into the evaluation module of the MGB. A marking on the stop makes adjustment easier.

LED indicator

The LED indicator indicates all important system and status information.

Monitoring outputs

- OD** ON when the door is closed
- OT** Bolt tongue inserted in the evaluation module
- OL** Guard locking solenoid in locked position
- OI** Diagnostics; there is a fault

Emergency stop device

- S1** 2 positively driven NC contacts and 1 NO contact (e.g. monitoring contact), emergency stop with turn-to-reset, not illuminated

Pushbutton

- S2** 1 NO contact, illuminated
- S3** 1 NO contact, illuminated

Lens set

The color of the pushbutton can be selected using the lens set included (5 colors). Item no.: 120344 (see Accessories)

Approvals



Mechanical values and environment

Housing material	Reinforced plastic; die-cast zinc nickel-plated, stainless steel
Weight	Net 0,75 kg
Ambient temperature	At $U_B = 24V DC$ -20 ... 55 °C
Degree of protection	IP65
Mechanical life	1×10^6
In case of use as door stop, and 1 Joule impact energy	$0,1 \times 10^6$
Installation position	Door hinge DIN right
Switching frequency	0,25 Hz
Connection	Cable entries M20x1.5
Guard locking principle	Open-circuit current principle
Locking force F_{Zh}	2000 N

Electrical connection ratings

Utilization category according to EN 60947-5-2	DC-13	24V 200mA ^[1]
Rated insulation voltage U_i		30 V
Rated impulse withstand voltage U_{imp}		1,5 kV
Degree of contamination (external, according to EN 60947-1)		3
Connection cross-section		
(Rigid/flexible)		0,13 ... 1,5 mm ²
(Rigid/flexible) with cable end sleeve according to DIN 46 228/1		0,25 ... 1,5 mm ²
(Rigid/flexible) with cable end sleeve with collar according to DIN 46 228/1		0,25 ... 0,75 mm ²
Safety class		III
Discrepancy time		
Between FO1A and FO1B		max.10 ms
Risk time according to EN 60947-5-3		max.350 ms
Transponder coding		Unicode
Power supply U_B		
Operating voltage DC	U_B	24 V DC -15% ... 10% ^[2]
Current consumption	I_{UB}	max.80 mA ^[3]
Power supply U_A		
Operating voltage DC	U_A	24 V DC -15% ... 10% ^[4]
Current consumption	I_{UA}	max.375 mA ^[5]
Safety outputs FO1A, FO1B		
Test pulses		max.1 ms
Test-pulse interval		min.100 ms
Type of output		Semiconductor outputs, p-switching, short circuit-proof
Output voltage		
U_{FO1A} / U_{FO1B} HIGH		$U_B - 2V \dots U_B$ V DC ^[6]
U_{FO1A} / U_{FO1B} LOW		0 ... 1 V DC
Output current		
Per safety output FO1A / FO1B		1 ... 200 mA
Monitoring outputs OD, OT, OL, OI		
Type of output		Semiconductor outputs, p-switching, short circuit-proof
Output voltage		$U_A - 2V \dots U_A$ V DC ^[7]
Output current		max.50 mA
Controls and indicators		
Switching voltage		U_A V
Switching current		1 ... 10 mA
Breaking capacity		max.0,25 W

Power supply LED	24 V DC
	Emergency stop
Switching voltage	5 ... 24 V
Switching current	1 ... 100 mA
Breaking capacity	max.0,25 W
Power supply LED	24 V DC
	Solenoid control input IMP1, IMP2, IMM
Test pulses	max.5 ms
Test-pulse interval	min.100 ms

Controls and indicators

Assignment diagram	L1
Control/indicator	
	Position 1
Version	Emergency stop
Special features	With auxiliary contact
Color	
Switching element	2 pos. driven NC + 1NO
Control/indicator	
	Position 2
Version	Illuminated push buttons
Special features	
Color	
Switching element	1NO
Control/indicator	
	Position 3
Version	Illuminated push buttons
Special features	
Color	
Switching element	1NO

Miscellaneous

Additional feature	Incl. cover set ID. No. 120344
Product version number	V3.0.3

Reliability values acc. to EN ISO 13849-1

	Monitoring of guard locking and the safety guard position
Category	4
Performance Level	PL e
PFH _D	3.7×10^{-9}
	Emergency stop

B10D

Emergency stop 0,065 x 10⁶

Mission time

20 y

- [1] Caution: outputs must be protected with a free-wheeling diode in case of inductive loads.
- [2, 4] (Reverse polarity protected, regulated, residual ripple <5%, PELV)
- [3] (no load on outputs)
- [5] (With energized guard locking solenoid and unloaded outputs OD, OT, OL, OI, +20 °C, 24V)
- [6, 7] Value at a switching current of 50mA without taking into account the cable lengths

Dimension drawing

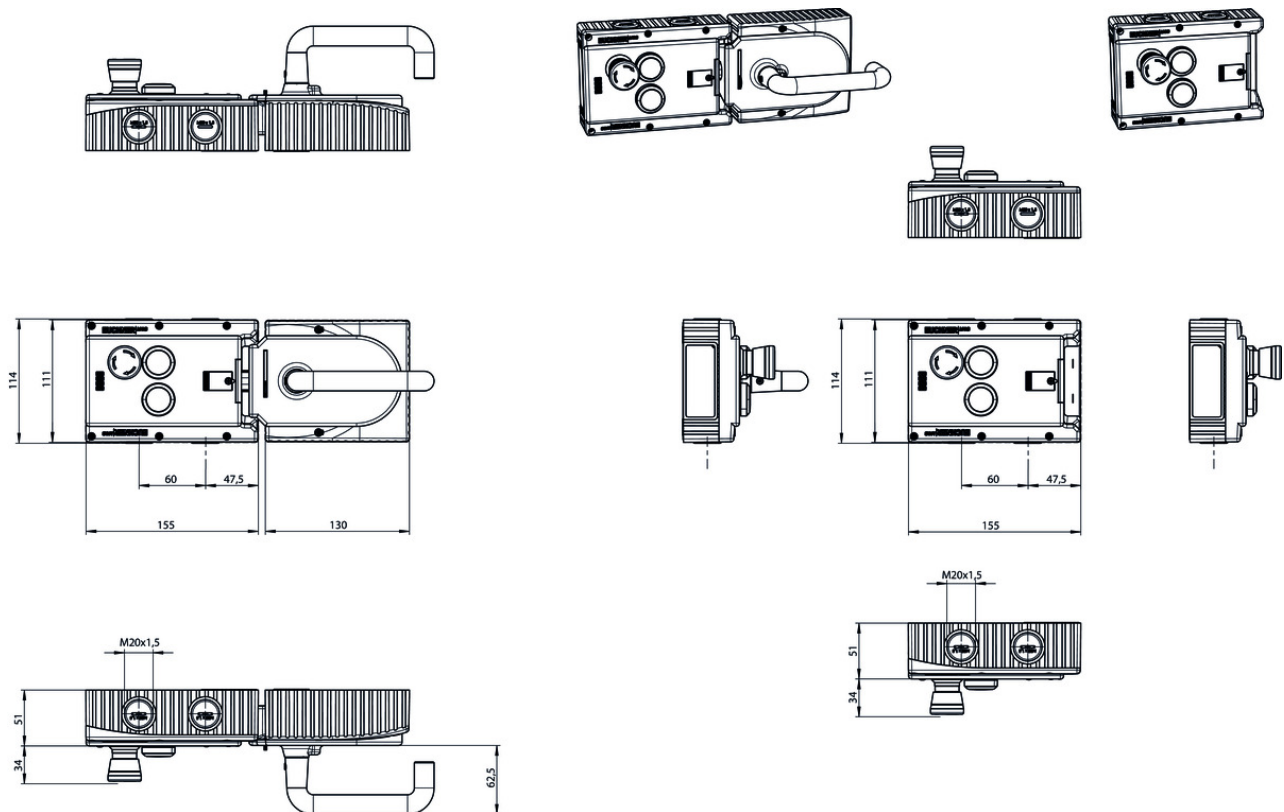

Cable entry

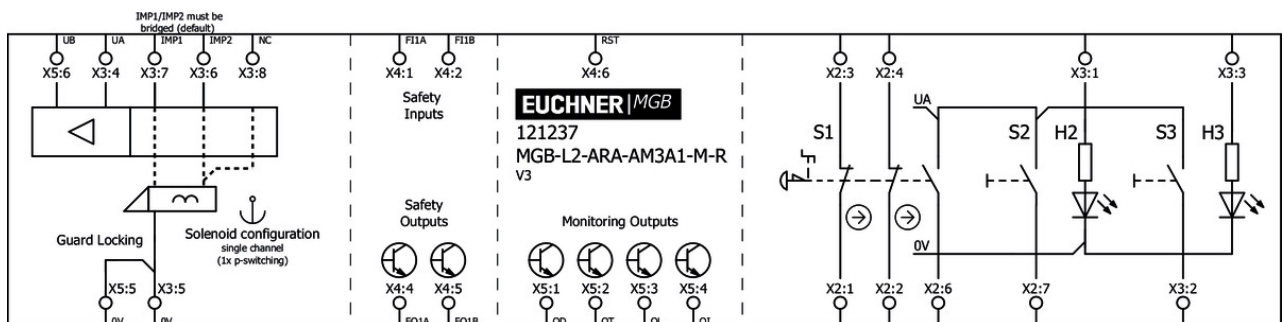

Miscellaneous accessories

▼ Lens set 5 colors



120344 AY-SET-LNS-0001-120344

▼ Lens set labeled



120377 AY-SET-LNS-SY01-120377



125359 AY-SET-LNS-SY02-125359



126158 AY-SET-LNS-SY03-126158

▼ Lens set 6 colors



120378 AY-SET-LNS-0002-120378

▼ Lens set, three colors



158307 AY-SET-LNS-SY04-158307

Connection material

▼ Built-in connector RC18

120403 MGB-A-PLUGCONNECTOR-RC18-120403

▼ Features

- › For all MGB with cable entry
-

▼ Cable glands M20x1.5



086233 EKPM20/06 086233

Mounting accessories

▼ Mounting plate for evaluation modules MGB-L.-AR.-... and MGB-L.-AP.-...

109490 MGB-A-MOUNTINGPLATE-L-109490

▼ Features



- › Easy and quick mounting (only two screws required)
- › Quick module replacement
- › Steel, powder-coated
- › Suitable for doors hinged on the right or left

Function expansion

Emergency unlocking for safety system MGB



112989 MGB-A-EMERGENCYRELEASE-112989

Features

- › Quick emergency unlocking
- › sealable

Instructions

▼ Návod k použití – bezpečnostní systémy MGB-L1...AR.-... / MGB-L2...AR.-... a MGB-L1...AP.-... / MGB-L2...AP.-... od V3.0.0

	Doc. no.	Version	Language	Download
Betriebsanleitung MGB-L1...AR.-... / MGB-L2...AR.-... und MGB-L1...AP.-... / MGB-L2...AP.-... ab V3.0.0	2119167	04-05/18		3.7 MB
Mode d'emploi MGB-L1...AR.-... / MGB-L2...AR.-... et MGB-L1...AP.-... / MGB-L2...AP.-... à partir de V3.0.0	2119167	04-05/18		3.7 MB
Manual de instrucciones MGB-L1...AR.-... / MGB-L2...AR.-... y MGB-L1...AP.-... / MGB-L2...AP.-... V3.0.0 o superior	2119167	04-05/18		3.7 MB
Návod k použití – bezpečnostní systémy MGB-L1...AR.-... / MGB-L2...AR.-... a MGB-L1...AP.-... / MGB-L2...AP.-... od V3.0.0	2119167	04-05/18		4.0 MB
Operating Instructions MGB-L1...AR.-... / MGB-L2...AR.-... and MGB-L1...AP.-... / MGB-L2...AP.-... from V3.0.0	2119167	04-05/18		3.7 MB
Istruzioni di impiego MGB-L1...AR.-... / MGB-L2...AR.-... und MGB-L1...AP.-... / MGB-L2...AP.-... da V3.0.0	2119167	04-05/18		3.7 MB
Handleiding MGB-L1...AR.-... / MGB-L2...AR.-... en MGB-L1...AP.-... / MGB-L2...AP.-... vanaf V3.0.0	2119167	04-05/18		3.7 MB
Instrukcja obsługi MGB-L1...AR.-... / MGB-L2...AR.-... i MGB-L1...AP.-... / MGB-L2...AP.-... od V3.0.0	2119167	04-05/18		4.0 MB
Manual de instruções MGB-L1...AR.-... / MGB-L2...AR.-... e MGB-L1...AP.-... / MGB-L2...AP.-... a partir de V3.0.0	2119167	04-05/18		3.7 MB

Инструкция по эксплуатации MGB-L1...AR.-... / MGB-L2...AR.-... и MGB-L1...AP.-... / MGB-L2...AP.-... с V3.0.0	2119167	04-05/18		4.2 MB
Návod na prevádzku Bezpečnostné systémy MGB-L1...AR.-... / MGB-L2...AR.-... a MGB-L1...AP.-... / MGB-L2...AP.-... od V3.0.0	2119167	04-05/18		4.0 MB
Instruktionsbok MGB-L1...AR.-... / MGB-L2...AR.-... och MGB-L1...AP.-... / MGB-L2...AP.-... fr. V3.0.0	2119167	04-05/18		3.7 MB
İşletim kılavuzu MGB-L1...AR.-... / MGB-L2...AR.-... ve MGB-L1...AP.-... / MGB-L2...AP.-... itibaren V3.0.0	2119167	04-05/18		4.1 MB
操作指示書 安全システム MGB-L1...AR.-... / MGB-L2...AR.-... および MGB-L1...AP.-... / MGB-L2...AP.-... V3.0.0以降	2119167	04-05/18		4.1 MB
使用说明书 安全系统 MGB-L1...AR.-... / MGB-L2...AR.-... 和 MGB-L1...AP.-... / MGB-L2...AP.-... V3.0.0 以上	2119167	04-05/18		4.1 MB







Sicherheitsinformation (Teil der Betriebsanleitung Sicherheitssystem MGB-AR/MGB-AP) ab V3.0.0

	Doc. no.	Version	Language	Download
Sicherheitsinformation (Teil der Betriebsanleitung Sicherheitssystem MGB-AR/MGB-AP) ab V3.0.0 Información de seguridad (parte del manual de instrucciones Sistema de seguridad MGB-AR/MGB-AP) V3.0.0 o superior Information de sécurité (partie du mode d'emploi Système de sécurité MGB-AR/MGB-AP) à partir de V3.0.0 Informazioni sulla sicurezza (Parte delle istruzioni di impiego Sistema di sicurezza MGB-AR/MGB-AP) da V3.0.0 Säkerhetsinformation (Del av instruktionsboken Säkerhetssystem MGB-AR/MGB-AP) från V3.0.0 Safety Information (Part of the Operating Instructions Safety System MGB-AR/MGB-AP) from V3.0.0	123151	01-02/15	 	0.6 MB
Veiligheidsinformatie (Deel van de handleiding Beveiligingssysteem MGB-AR/MGB-AP) vanaf V3.0.0	123151	01-02/15		0.2 MB
Informação de segurança (Parte do manual de instruções Sistema de segurança MGB-AR/MGB-AP) a partir de V3.0.0	123151	01-02/15		0.2 MB
Bezpečnostní informace (součást návodu k použití „Bezpečnostní systém MGB-AR/MGB-AP“) od V3.0.0	123151	01-02/15		0.2 MB
Informacje o bezpieczeństwie (Część instrukcji obsługi System bezpieczeństwa MGB-AR/MGB-AP) od V3.0.0	123151	01-02/15		0.2 MB
Информация о безопасности (часть инструкции по эксплуатации Предохранительная система MGB-AR/MGB-AP) с V3.0.0	123151	01-02/15		0.3 MB

Bezpečnostná informácia (časť návodu na prevádzku Bezpečnostný systém MGB-AR/MGB-AP) od V3.0.0	123151	01-02/15		 0.2 MB
Güvenlik bilgisi (İşletim kılavuzunun parçası emniyet sistemi MGB-AR/MGB-AP) V3.0.0 ve üstü	123151	01-02/15		 0.3 MB
安全信息 (安全系统 MGB-AR/MGB-AP使用说明书的组成部分) V3.0.0以上	123151	01-02/15		 0.3 MB
安全情報 MGB-AR/MGB-AP	123151	01-02/15		 0.6 MB

Declaration of conformity

EU-Konformitätserklärung

	Doc. no.	Version	Language	Download
EU-Konformitätserklärung Declaración UE de conformidad Déclaration UE de conformité Dichiarazione di conformità EU declaration of conformity	2123150	08-01/17	    	 0.3 MB