

ITEM 121051 MGB-L1H-ARA-R-121051

Description	Technical data	Accessories	Downloads
-------------	----------------	-------------	-----------

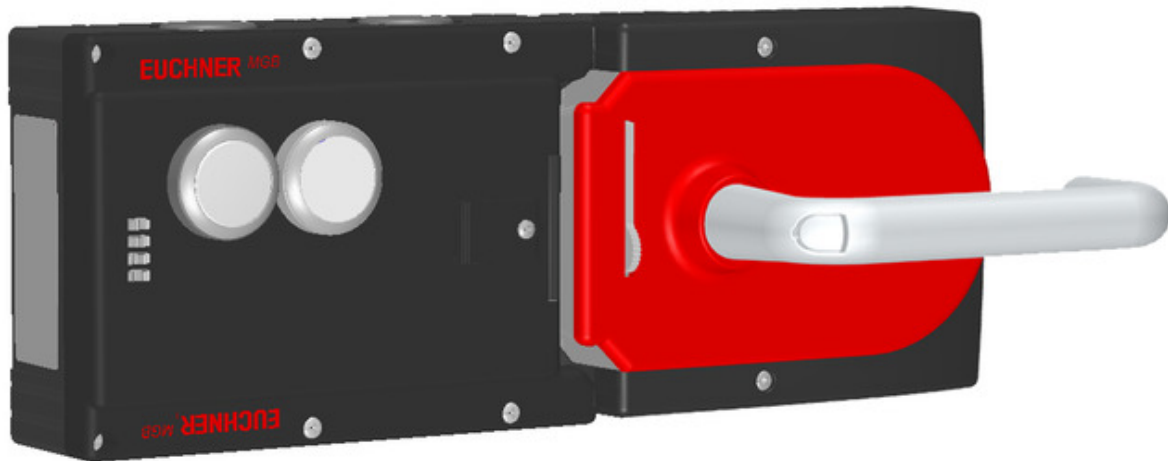

Features

- › Guard locking with guard lock monitoring
- › Can be connected in series with other AR devices (e.g. CES-AR and CET-AR)
- › 2 pushbuttons (illuminated)
- › With lens set, 6 pcs.
- › With cable entry
- › Unicode

Guard locking type

MGB- The locking arm is held in the locked position by spring force and is
L1... unlocked by solenoid force (closed-circuit current principle, mechanically locked).

Door hinge

A mechanical door stop is permanently integrated into the evaluation module of the MGB. A marking on the stop makes adjustment easier.

LED indicator

The LED indicator indicates all important system and status information.

Monitoring outputs

- OD** ON when the door is closed
 - OT** Bolt tongue inserted in the evaluation module
 - OL** Guard locking solenoid in locked position
 - OI** Diagnostics; there is a fault
-

Pushbutton

- S1** 1 NO contact, illuminated
 - S2** 1 NO contact, illuminated
-

Lens set

The color of the pushbutton can be selected using the lens set included (5 colors). Item no.: 120344 (see Accessories)

Components included in the set



121050 Locking module MGB-L1-ARA-AL1A1-M-R-121050
▼ Features



100464 Handle module MGB-H-AA1A1-R-100464
▼ Features

Dimension drawing

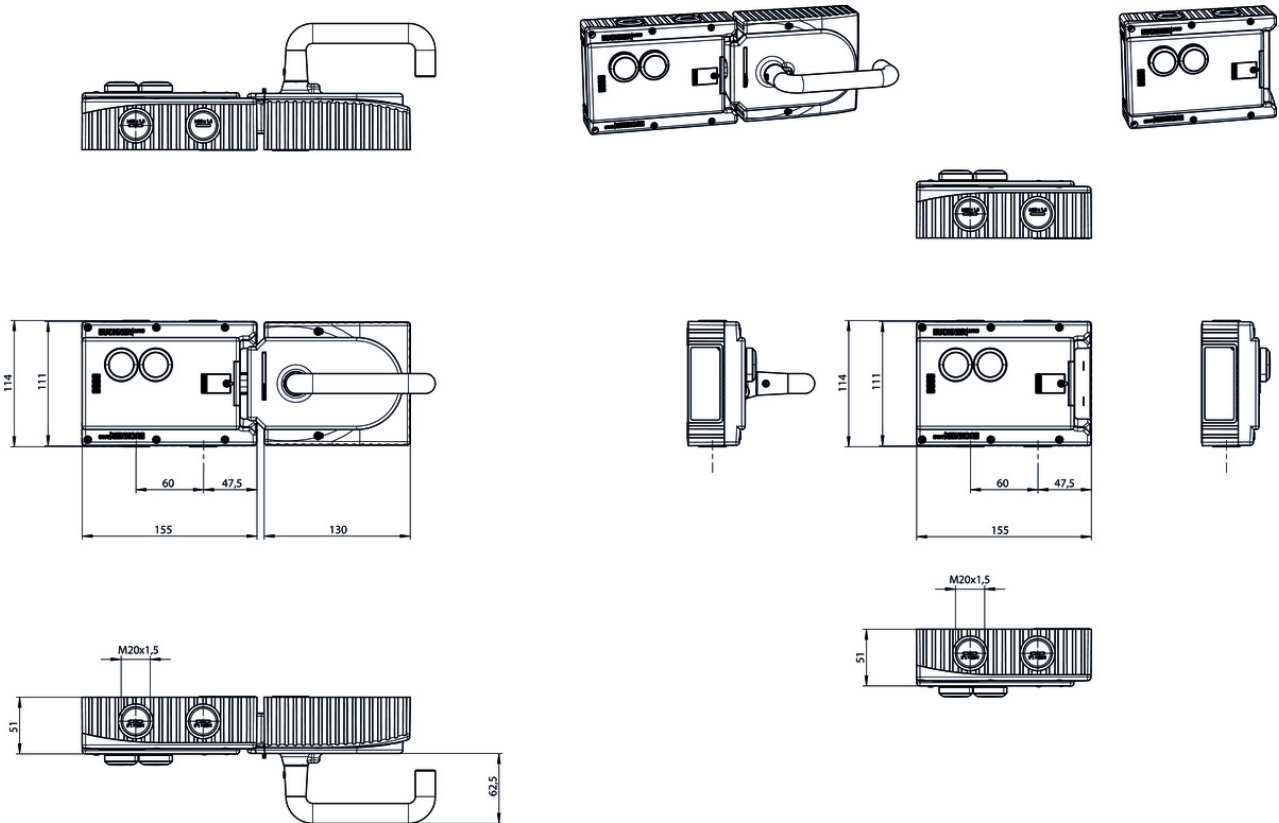

Cable entry

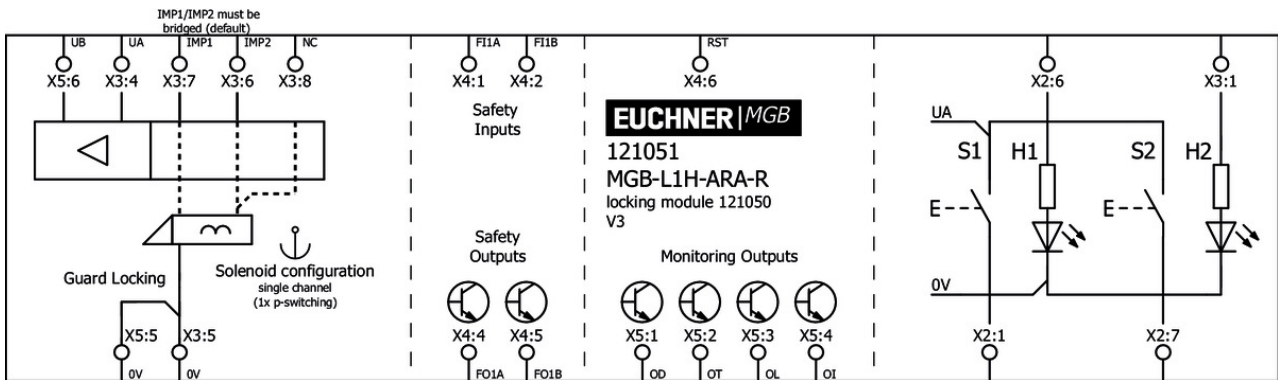

Function expansion

Escape release MGB-E-A...



100465 MGB-E-A-100465

Features

- › Escape release from the danger zone
- › Door handle signal red
- › Extended actuation axis for thicker doors (available optionally)

Emergency unlocking for safety system MGB

112989 MGB-A-EMERGENCYRELEASE-112989



- ✓ Features
 - › Quick emergency unlocking
 - › sealable
-

✓ Door knob for MGB-H...



- 111460** MGB-A-DOORKNOB-S1-111460
- ✓ Features
 - › Aluminum, silver anodized
 - › For mounting on all MGB handle modules MGB-H... up to V2.0.0
 - › e.g. on sliding doors
-



- 124030** MGB-A-DOORKNOB-S2-124030
- ✓ Features
 - › Aluminum, silver anodized
 - › For mounting on all MGB handle modules MGB-H... from V3.0.0
 - › e.g. on sliding doors
-

✓ Door handle for MGB-H...



- 110277** MGB-A-DOORHANDLE-S1-110277
- ✓ Features
 - › Aluminum silver anodized
 - › For mounting on all MGB handle modules MGB-H up to V2.0.0
-



- 123926** MGB-A-DOORHANDLE-S2-123926
- ✓ Features
 - › Aluminum silver anodized
 - › For mounting on all MGB handle modules MGB-H from V3.0.0
-

Miscellaneous accessories

✓ Lens set labeled



120377 AY-SET-LNS-SY01-120377



125359 AY-SET-LNS-SY02-125359



126158 AY-SET-LNS-SY03-126158

✓ Lens set 6 colors



120378 AY-SET-LNS-0002-120378

▼ Lens set 5 colors



120344 AY-SET-LNS-0001-120344

▼ Lens set, three colors



158307 AY-SET-LNS-SY04-158307

Mounting accessories

▼ Mounting plate for all MGB handle modules



109491 MGB-A-MOUNTINGPLATE-H-109491

▼ Features

- › Easy and quick mounting (only two screws required)
- › Quick module replacement
- › Steel, powder-coated
- › Suitable for doors hinged on the right or left

▼ Mounting plate for evaluation modules MGB-L.-AR.-... and MGB-L.-AP.-...



109490 MGB-A-MOUNTINGPLATE-L-109490

▼ Features

- › Easy and quick mounting (only two screws required)
- › Quick module replacement
- › Steel, powder-coated
- › Suitable for doors hinged on the right or left

Spare parts

▼ Locking module MGB-L1-ARA..., (guard locking by spring force) with 2 push buttons



121050 MGB-L1-ARA-AL1A1-M-R-121050

▼ Features

- › Guard locking with guard lock monitoring
- › Can be connected in series with other AR devices (e.g. CES-AR and CET-AR)
- › 2 pushbuttons (illuminated)
- › With lens set, 6 pcs.
- › With cable entry
- › Unicode

▼ Handle module MGB-H-...



100464 MGB-H-AA1A1-R-100464

▼ Features

- › Intelligent bolt tongue
- › Lockout bar

Connection material

▼ Built-in connector RC18























120403 MGB-A-PLUGCONNECTOR-RC18-120403







▼ Features

- › For all MGB with cable entry





















Instructions

▼ Návod k použití – bezpečnostní systémy MGB-L1...AR.-... / MGB-L2...AR.-... a MGB-L1...AP.-... / MGB-L2...AP.-... od V3.0.0

	Doc. no.	Version	Language	Download
Betriebsanleitung MGB-L1...AR.-... / MGB-L2...AR.-... und MGB-L1...AP.-... / MGB-L2...AP.-... ab V3.0.0	2119167	04-05/18		 3.7 MB
Mode d'emploi MGB-L1...AR.-... / MGB-L2...AR.-... et MGB-L1...AP.-... / MGB-L2...AP.-... à partir de V3.0.0	2119167	04-05/18		 3.7 MB
Manual de instrucciones MGB-L1...AR.-... / MGB-L2...AR.-... y MGB-L1...AP.-... / MGB-L2...AP.-... V3.0.0 o superior	2119167	04-05/18		 3.7 MB
Návod k použití – bezpečnostní systémy MGB-L1...AR.-... / MGB-L2...AR.-... a MGB-L1...AP.-... / MGB-L2...AP.-... od V3.0.0	2119167	04-05/18		 4.0 MB
Operating Instructions MGB-L1...AR.-... / MGB-L2...AR.-... and MGB-L1...AP.-... / MGB-L2...AP.-... from V3.0.0	2119167	04-05/18		 3.7 MB
Istruzioni di impiego MGB-L1...AR.-... / MGB-L2...AR.-... und MGB-L1...AP.-... / MGB-L2...AP.-... da V3.0.0	2119167	04-05/18		 3.7 MB
Handleiding MGB-L1...AR.-... / MGB-L2...AR.-... en MGB-L1...AP.-... / MGB-L2...AP.-... vanaf V3.0.0	2119167	04-05/18		 3.7 MB
Instrukcja obsługi MGB-L1...AR.-... / MGB-L2...AR.-... i MGB-L1...AP.-... / MGB-L2...AP.-... od V3.0.0	2119167	04-05/18		 4.0 MB
Manual de instruções MGB-L1...AR.-... / MGB-L2...AR.-... e MGB-L1...AP.-... / MGB-L2...AP.-... a partir de V3.0.0	2119167	04-05/18		 3.7 MB
Инструкция по эксплуатации MGB-L1...AR.-... / MGB-L2...AR.-... и MGB-L1...AP.-... / MGB-L2...AP.-... с V3.0.0	2119167	04-05/18		 4.2 MB
Návod na prevádzku Bezpečnostné systémy MGB-L1...AR.-... / MGB-L2...AR.-... a MGB-L1...AP.-... / MGB-L2...AP.-... od V3.0.0	2119167	04-05/18		 4.0 MB

Instruktionsbok MGB-L1...AR.-... / MGB-L2...AR.-... och MGB-L1...AP.-... / MGB-L2...AP.-... fr. V3.0.0	2119167	04-05/18		 3.7 MB
İşletim kılavuzu MGB-L1...AR.-... / MGB-L2...AR.-... ve MGB-L1...AP.-... / MGB-L2...AP.-... itibaren V3.0.0	2119167	04-05/18		 4.1 MB
操作指示書 安全システム MGB-L1...-AR.-... / MGB- L2...-AR.-... および MGB-L1...-AP.-... / MGB-L2...- AP.-... V3.0.0以降	2119167	04-05/18		 4.1 MB
使用说明书 安全系统 MGB-L1...-AR.-... / MGB-L2...- AR.-...和MGB-L1...-AP.-... / MGB-L2...-AP.-... V3.0.0 以上	2119167	04-05/18		 4.1 MB













 **Sicherheitsinformation (Teil der Betriebsanleitung Sicherheitssystem MGB-AR/MGB-AP) ab V3.0.0**

	Doc. no.	Version	Language	Download
Sicherheitsinformation (Teil der Betriebsanleitung Sicherheitssystem MGB- AR/MGB-AP) ab V3.0.0 Información de seguridad (parte del manual de instrucciones Sistema de seguridad MGB- AR/MGB-AP) V3.0.0 o superior Information de sécurité (partie du mode d'emploi Système de sécurité MGB-AR/MGB-AP) à partir de V3.0.0 Informazioni sulla sicurezza (Parte delle istruzioni di impiego Sistema di sicurezza MGB-AR/MGB- AP) da V3.0.0 Säkerhetsinformation (Del av instruktionsboken Säkerhetssystem MGB-AR/MGB-AP) från V3.0.0 Safety Information (Part of the Operating Instructions Safety System MGB-AR/MGB-AP) from V3.0.0	123151	01-02/15	     	 0.6 MB
Veiligheidsinformatie (Deel van de handleiding Beveiligingssysteem MGB-AR/MGB-AP) vanaf V3.0.0	123151	01-02/15		 0.2 MB
Informação de segurança (Parte do manual de instruções Sistema de segurança MGB-AR/MGB- AP) a partir de V3.0.0	123151	01-02/15		 0.2 MB
Bezpečnostní informace (součást návodu k použití „Bezpečnostní systém MGB-AR/MGB-AP“) od V3.0.0	123151	01-02/15		 0.2 MB
Informacje o bezpieczeństwie (Część instrukcji obsługi System bezpieczeństwa MGB-AR/MGB- AP) od V3.0.0	123151	01-02/15		 0.2 MB
Информация о безопасности (часть инструкции по эксплуатации Предохранительная система MGB-AR/MGB-AP) с V3.0.0	123151	01-02/15		 0.3 MB
Bezpečnostná informácia (časť návodu na prevádzku Bezpečnostný systém MGB-AR/MGB- AP) od V3.0.0	123151	01-02/15		 0.2 MB
Güvenlik bilgisi (İşletim kılavuzunun parçası emniyet sistemi MGB-AR/MGB-AP) V3.0.0 ve üstü	123151	01-02/15		 0.3 MB

安全信息 (安全系统 MGB-AR/MGB-AP使用说明书的组成部分) V3.0.0以上	123151	01-02/15		 0.3 MB
安全情報 MGB-AR/MGB-AP	123151	01-02/15		 0.6 MB





Catalogs

- Multifunctional Gate Box MGB Multifunctional Gate Box MGB Multifunctional Gate Box MGB Multifunctional Gate Box MGB Multifunctional Gate Box MGB Multifunctional Gate Box MGB 多功能系统安全控制系统 MGB

	Doc. no.	Version	Language	Download
Multifunctional Gate Box MGB	106108	10-02/18		 8.2 MB
Multifunctional Gate Box MGB	109155	10-02/18		 8.2 MB
Multifunctional Gate Box MGB	114433	10-02/18		 8.3 MB
Multifunctional Gate Box MGB	121652	10-02/18		 8.0 MB
Multifunctional Gate Box MGB	106109	10-02/18		 8.2 MB
多功能系统安全控制系统 MGB	155883	10-02/18		 8.3 MB

Declaration of conformity

- EU-Konformitätserklärung

	Doc. no.	Version	Language	Download
EU-Konformitätserklärung	2123150	08-01/17		 0.3 MB
Declaración UE de conformidad				
Déclaration UE de conformité				
Dichiarazione di conformità				
EU declaration of conformity			