

ITEM 121202 MGB-L2H-ARA-R-121202

Description	Technical data	Accessories	Downloads
-------------	----------------	-------------	-----------

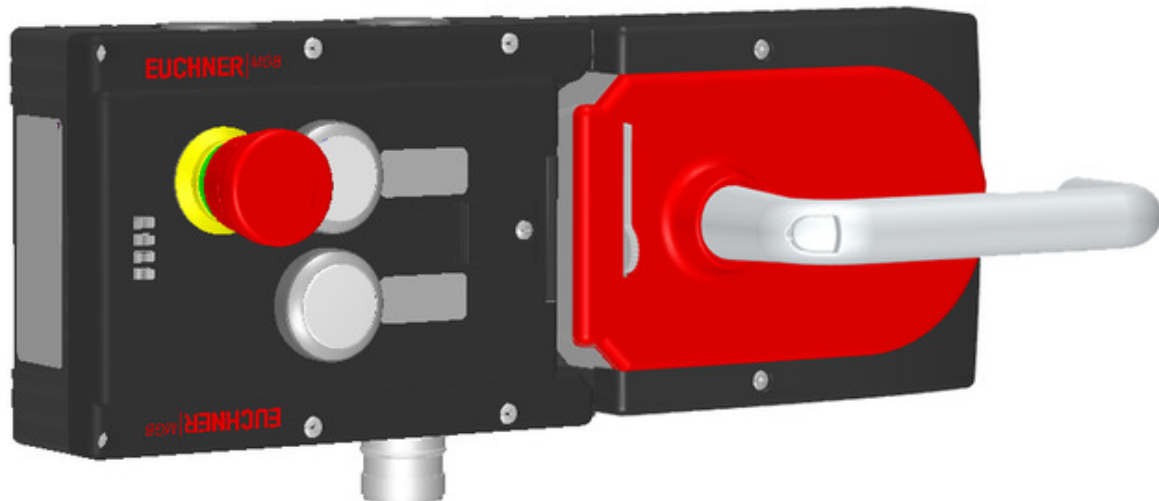

Features

- › Guard locking with guard lock monitoring
- › Can be connected in series with other AR devices (e.g. CES-AR and CET-AR)
- › Emergency stop according to ISO 13850
- › 2 pushbuttons (illuminated)
- › With lens set, 6 pcs.
- › Incl. adhesive labels
- › With plug connector RC18
- › Unicode

Guard locking type

MGB- The locking arm is kept in locked position by solenoid force and
L2... unlocked by spring force when the solenoid is switched off (open-circuit current principle, electrically locked).

Door hinge

A mechanical door stop is permanently integrated into the evaluation module of the MGB. A marking on the stop makes adjustment easier.

LED indicator

The LED indicator indicates all important system and status information.

Monitoring outputs

- OL** Guard locking solenoid in locked position
 - OI** Diagnostics; there is a fault
-

Emergency stop device

- S1** 2 positively driven NC contacts, emergency stop with turn-to-reset, not illuminated
-

Pushbutton

- S2** 1 NO contact, illuminated
 - S3** 1 NO contact, illuminated
-

Lens set

The color of the pushbutton can be selected using the lens set included (5 colors). Item no.: 120344 (see Accessories)

Adhesive labels

Devices with adhesive labels have pre-formed recesses. The adhesive labels enclosed (standard size 12.5 x 27 mm) can be affixed in these recesses.

Components included in the set



- 121201 Locking module MGB-L2-ARA-AM5A1-S1-R-121201
 - Features
-



- 100464 Handle module MGB-H-AA1A1-R-100464
 - Features
-

Dimension drawing

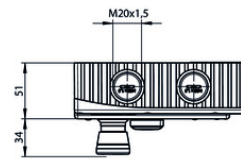
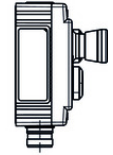
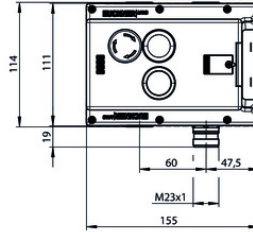
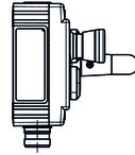
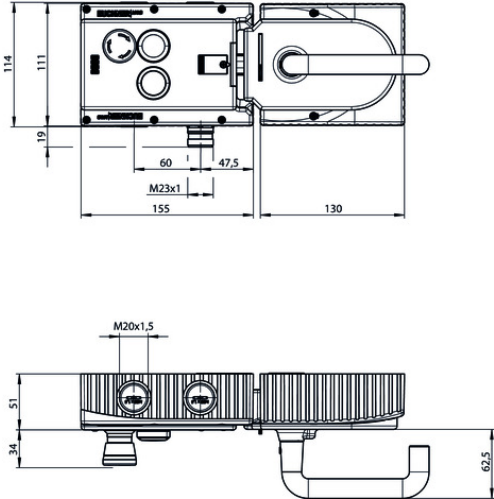
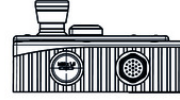
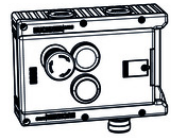
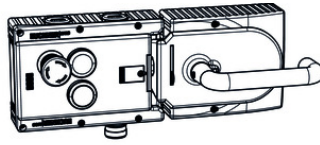
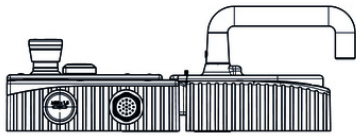

Dimension drawing

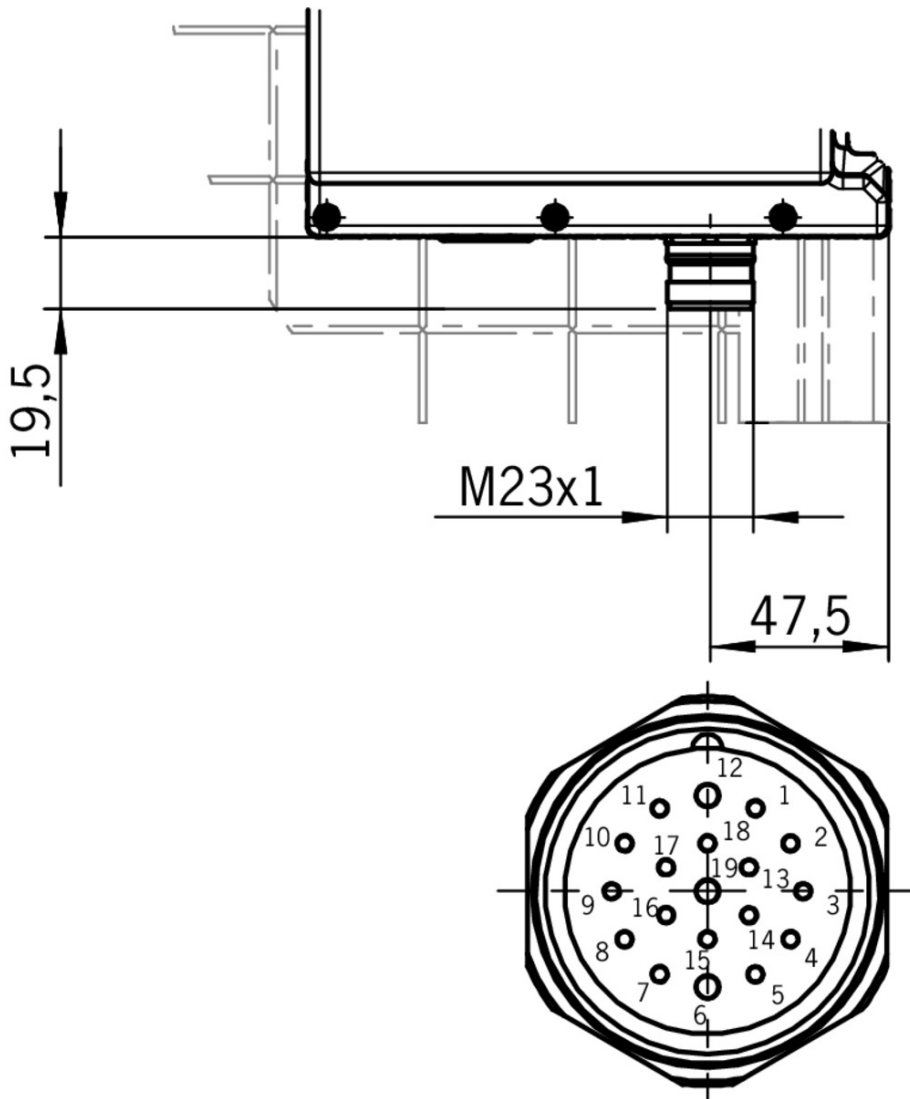

Plug connector RC18

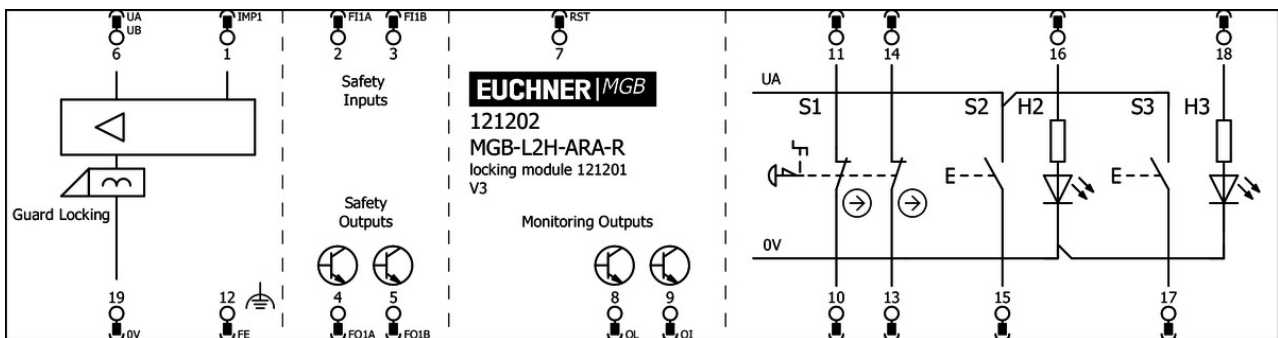

Spare parts

- ✓ Locking module MGB-L2-ARA..., (guard locking by solenoid force) with 2 push buttons, emergency stop, incl. label carrier, RC18



121201 MGB-L2-ARA-AM5A1-S1-R-121201

- ✓ Features

- › Guard locking with guard lock monitoring
- › Can be connected in series with other AR devices (e.g. CES-AR and CET-AR)
- › Emergency stop according to ISO 13850
- › 2 pushbuttons (illuminated)
- › With lens set, 6 pcs.
- › Incl. adhesive labels
- › With plug connector RC18
- › Unicode

▼ Handle module MGB-H...



100464 MGB-H-AA1A1-R-100464

▼ Features

- › Intelligent bolt tongue
- › Lockout bar
- › Door handle

Function expansion

▼ Escape release MGB-E-A...



100465 MGB-E-A-100465

▼ Features

- › Escape release from the danger zone
- › Door handle signal red
- › Extended actuation axis for thicker doors (available optionally)

▼ Door knob for MGB-H...



111460 MGB-A-DOORKNOB-S1-111460

▼ Features

- › Aluminum, silver anodized
- › For mounting on all MGB handle modules MGB-H... up to V2.0.0
- › e.g. on sliding doors



124030 MGB-A-DOORKNOB-S2-124030

▼ Features

- › Aluminum, silver anodized
- › For mounting on all MGB handle modules MGB-H... from V3.0.0
- › e.g. on sliding doors

▼ Door handle for MGB-H...



110277 MGB-A-DOORHANDLE-S1-110277

▼ Features

- › Aluminum silver anodized
- › For mounting on all MGB handle modules MGB-H up to V2.0.0

123926 MGB-A-DOORHANDLE-S2-123926



- ▼ Features
 - › Aluminum silver anodized
 - › For mounting on all MGB handle modules MGB-H from V3.0.0
-

- ▼ Emergency unlocking for safety system MGB



- 112989** MGB-A-EMERGENCYRELEASE-112989
 - ▼ Features
 - › Quick emergency unlocking
 - › sealable
-

Mounting accessories

- ▼ Mounting plate for evaluation modules MGB-L.-AR.-... and MGB-L.-AP.-...



- 109490** MGB-A-MOUNTINGPLATE-L-109490
 - ▼ Features
 - › Easy and quick mounting (only two screws required)
 - › Quick module replacement
 - › Steel, powder-coated
 - › Suitable for doors hinged on the right or left
-

- ▼ Mounting plate for all MGB handle modules



- 109491** MGB-A-MOUNTINGPLATE-H-109491
 - ▼ Features
 - › Easy and quick mounting (only two screws required)
 - › Quick module replacement
 - › Steel, powder-coated
 - › Suitable for doors hinged on the right or left
-

Connection material

- ▼ Female plug RC18 straight with option C1825



- 077025** RC18EF-C1825
 - ▼ Features
 - › Plug connector M23, straight
 - › Number of pins: 19-pin with screen bonding clamp
-

- ▼ Replacement crimp contacts for female connector RC18 with option C1825

- 094310** CRIMPKONTAKT BUCHSE RCF-C1825
 - ▼ Features
 - › 19 crimp sockets
 - › Conductor cross-section 16 x 0.25 - 0.5 mm² and 3 x 0.75 - 1 mm²
 - › For plug connector RC18..C1825
-

- ▼ Connection cable with plug connector M23 with option C1825, 1.5m, straight



092761 C-M23F19-19XDIFPU01,5-MA-092761

▼ Features

- › M23 plug connector, 18-pin + PE
 - › Straight plug connector
 - › PUR cable
 - › Cable length 1.5 m
 - › With flying lead
 - › Cores color-coded
-

- ▼ Connection cable with plug connector M23 with option C1825, 3m, straight



092816 C-M23F19-19XDIFPU03,0-MA-092816

▼ Features

- › M23 plug connector, 18-pin + PE
 - › Straight plug connector
 - › PUR cable
 - › Cable length 3 m
 - › With flying lead
 - › Cores color-coded
-

- ▼ Connection cable with plug connector M23 with option C1825, 6m, straight



077014 C-M23F19-19XDIFPU06,0-MA-077014

▼ Features

- › M23 plug connector, 18-pin + PE
 - › Straight plug connector
 - › PUR cable
 - › Cable length 6 m
 - › With flying lead
 - › Cores color-coded
-

- ▼ Connection cable with plug connector M23 with option C1825, 10m, straight



092898 C-M23F19-19XDIFPU10,0-MA-092898

▼ Features

- › M23 plug connector, 18-pin + PE
 - › Straight plug connector
 - › PUR cable
 - › Cable length 10 m
 - › With flying lead
 - › Cores color-coded
-

- ▼ Connection cable with plug connector M23 with option C1825, 8m, straight



077015 C-M23F19-19XDIFPU08,0-MA-077015

▼ Features

- › M23 plug connector, 18-pin + PE
- › Straight plug connector
- › PUR cable
- › Cable length 8 m
- › With flying lead

- › Cores color-coded
-

- ▼ Connection cable with plug connector M23 with option C1825, 15m, straight



077016 C-M23F19-19XDIFPU15,0-MA-077016

▼ Features

- › M23 plug connector, 18-pin + PE
 - › Straight plug connector
 - › PUR cable
 - › Cable length 15 m
 - › With flying lead
 - › Cores color-coded
-

- ▼ Connection cable with plug connector M23 with option C1825, 20m, straight



092726 C-M23F19-19XDIFPU20,0-MA-092726

▼ Features

- › M23 plug connector, 18-pin + PE
 - › Straight plug connector
 - › PUR cable
 - › Cable length 20 m
 - › With flying lead
 - › Cores color-coded
-

- ▼ Connection cable with plug connector M23 with option C1825, 25m, straight



092727 C-M23F19-19XDIFPU25,0-MA-092727

▼ Features

- › M23 plug connector, 18-pin + PE
 - › Straight plug connector
 - › PUR cable
 - › Cable length 25 m
 - › With flying lead
 - › Cores color-coded
-

- ▼ Connection cable with plug connector M23 with option C1825, 40m, straight



102490 C-M23F19-19XDIFPU40,0-MA-102490

▼ Features

- › M23 plug connector, 18-pin + PE
 - › Straight plug connector
 - › PUR cable
 - › Cable length 40 m
 - › With flying lead
 - › Cores color-coded
-

- ▼ Connection cable with plug connector M23 with option C1825, 30m, straight



095993 C-M23F19-19XDIFPU30,0-MA-095993

▼ Features

- › M23 plug connector, 18-pin + PE
- › Straight plug connector

- › PUR cable
- › Cable length 30 m
- › With flying lead
- › Cores color-coded

▼ Connection cable with plug connector M23, 19-pin, 30m, straight



122434 C-M23F19-19XDIFPU30,0-MA-122434

▼ Features

- › M23 female plug, 19-pin
- › Straight plug connector
- › PUR cable
- › Cable length 30 m
- › With flying lead
- › Cores numbered, black

Miscellaneous accessories

▼ Lens set 5 colors



120344 AY-SET-LNS-0001-120344

▼ Lens set 6 colors



120378 AY-SET-LNS-0002-120378

▼ Lens set labeled



120377 AY-SET-LNS-SY01-120377



125359 AY-SET-LNS-SY02-125359



126158 AY-SET-LNS-SY03-126158

▼ Adhesive labels

114529 MGB-A-PLATESET-NN01-114529

▼ Features

- › Adhesive labels suitable for MGB evaluation modules, bus modules and control modules
- › silver, blank
- › Packaging unit = 10 pcs.

▼ Lens set, three colors



Instructions

- ▼ Návod k použití – bezpečnostní systémy MGB-L1...AR-... / MGB-L2...AR-... a MGB-L1...AP-... / MGB-L2...AP-... od V3.0.0

	Doc. no.	Version	Language	Download
Betriebsanleitung MGB-L1...AR-... / MGB-L2...AR-... und MGB-L1...AP-... / MGB-L2...AP-... ab V3.0.0	2119167	04-05/18		3.7 MB
Mode d'emploi MGB-L1...AR-... / MGB-L2...AR-... et MGB-L1...AP-... / MGB-L2...AP-... à partir de V3.0.0	2119167	04-05/18		3.7 MB
Manual de instrucciones MGB-L1...AR-... / MGB-L2...AR-... y MGB-L1...AP-... / MGB-L2...AP-... V3.0.0 o superior	2119167	04-05/18		3.7 MB
Návod k použití – bezpečnostní systémy MGB-L1...AR-... / MGB-L2...AR-... a MGB-L1...AP-... / MGB-L2...AP-... od V3.0.0	2119167	04-05/18		4.0 MB
Operating Instructions MGB-L1...AR-... / MGB-L2...AR-... and MGB-L1...AP-... / MGB-L2...AP-... from V3.0.0	2119167	04-05/18		3.7 MB
Istruzioni di impiego MGB-L1...AR-... / MGB-L2...AR-... und MGB-L1...AP-... / MGB-L2...AP-... da V3.0.0	2119167	04-05/18		3.7 MB
Handleiding MGB-L1...AR-... / MGB-L2...AR-... en MGB-L1...AP-... / MGB-L2...AP-... vanaf V3.0.0	2119167	04-05/18		3.7 MB
Instrukcja obsługi MGB-L1...AR-... / MGB-L2...AR-... i MGB-L1...AP-... / MGB-L2...AP-... od V3.0.0	2119167	04-05/18		4.0 MB
Manual de instruções MGB-L1...AR-... / MGB-L2...AR-... e MGB-L1...AP-... / MGB-L2...AP-... a partir de V3.0.0	2119167	04-05/18		3.7 MB
Инструкция по эксплуатации MGB-L1...AR-... / MGB-L2...AR-... и MGB-L1...AP-... / MGB-L2...AP-... с V3.0.0	2119167	04-05/18		4.2 MB
Návod na prevádzku Bezpečnostné systémy MGB-L1...AR-... / MGB-L2...AR-... a MGB-L1...AP-... / MGB-L2...AP-... od V3.0.0	2119167	04-05/18		4.0 MB
Instruktionsbok MGB-L1...AR-... / MGB-L2...AR-... och MGB-L1...AP-... / MGB-L2...AP-... fr. V3.0.0	2119167	04-05/18		3.7 MB
İşletim kılavuzu MGB-L1...AR-... / MGB-L2...AR-... ve MGB-L1...AP-... / MGB-L2...AP-... itibaren V3.0.0	2119167	04-05/18		4.1 MB
操作指示書 安全システム MGB-L1...AR-... / MGB-L2...AR-... および MGB-L1...AP-... / MGB-L2...AP-... V3.0.0以降	2119167	04-05/18		4.1 MB

使用说明书 安全系统 MGB-L1····AR···· / MGB-L2····
AR····和MGB-L1····AP···· / MGB-L2····AP···· V3.0.0
以上

2119167

04-05/18



4.1 MB





▼ Sicherheitsinformation (Teil der Betriebsanleitung Sicherheitssystem MGB-AR/MGB-AP) ab V3.0.0

	Doc. no.	Version	Language	Download
Sicherheitsinformation (Teil der Betriebsanleitung Sicherheitssystem MGB-AR/MGB-AP) ab V3.0.0 Información de seguridad (parte del manual de instrucciones Sistema de seguridad MGB-AR/MGB-AP) V3.0.0 o superior Information de sécurité (partie du mode d'emploi Système de sécurité MGB-AR/MGB-AP) à partir de V3.0.0 Informazioni sulla sicurezza (Parte delle istruzioni di impiego Sistema di sicurezza MGB-AR/MGB-AP) da V3.0.0 Säkerhetsinformation (Del av instruktionsboken Säkerhetssystem MGB-AR/MGB-AP) från V3.0.0 Safety Information (Part of the Operating Instructions Safety System MGB-AR/MGB-AP) from V3.0.0	123151	01-02/15	 	0.6 MB
Veiligheidsinformatie (Deel van de handleiding Beveiligingssysteem MGB-AR/MGB-AP) vanaf V3.0.0	123151	01-02/15		0.2 MB
Informação de segurança (Parte do manual de instruções Sistema de segurança MGB-AR/MGB-AP) a partir de V3.0.0	123151	01-02/15		0.2 MB
Bezpečnostní informace (součást návodu k použití „Bezpečnostní systém MGB-AR/MGB-AP“) od V3.0.0	123151	01-02/15		0.2 MB
Informacje o bezpieczeństwie (Część instrukcji obsługi System bezpieczeństwa MGB-AR/MGB-AP) od V3.0.0	123151	01-02/15		0.2 MB
Информация о безопасности (часть инструкции по эксплуатации Предохранительная система MGB-AR/MGB-AP) с V3.0.0	123151	01-02/15		0.3 MB
Bezpečnostná informácia (časť návodu na prevádzku Bezpečnostný systém MGB-AR/MGB-AP) od V3.0.0	123151	01-02/15		0.2 MB
Güvenlik bilgisi (İşletim kılavuzunun parçası emniyet sistemi MGB-AR/MGB-AP) V3.0.0 ve üstü	123151	01-02/15		0.3 MB
安全信息 (安全系统 MGB-AR/MGB-AP使用说明书的组成部分) V3.0.0以上	123151	01-02/15		0.3 MB
安全情報 MGB-AR/MGB-AP	123151	01-02/15		0.6 MB

Declaration of conformity

▼ EU-Konformitätserklärung

Doc. no. Version Language Download

EU-Konformitätserklärung	2123150	08-01/17		 0.3 MB
Declaración UE de conformidad				
Déclaration UE de conformité				
Dichiarazione di conformità				
EU declaration of conformity			