

ITEM 121089 MGB-L1HE-ARA-L-121089

| Description | Technical data | Accessories | Downloads |
|-------------|----------------|-------------|-----------|
|-------------|----------------|-------------|-----------|

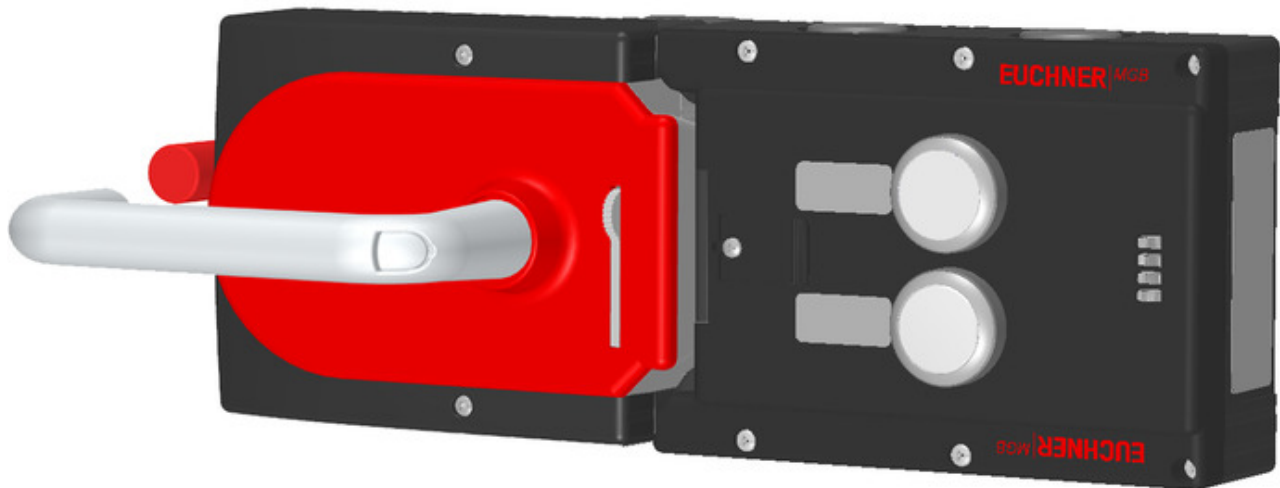

Features

- › Guard locking with guard lock monitoring
- › Can be connected in series with other AR devices (e.g. CES-AR and CET-AR)
- › 2 pushbuttons (illuminated)
- › With lens set, 6 pcs.
- › Incl. adhesive labels
- › With cable entry
- › With escape release
- › Unicode

Guard locking type

MGB- The locking arm is held in the locked position by spring force and is
L1... unlocked by solenoid force (closed-circuit current principle, mechanically locked).

Door hinge

A mechanical door stop is permanently integrated into the evaluation module of the MGB. A marking on the stop makes adjustment easier.

LED indicator

The LED indicator indicates all important system and status information.

Monitoring outputs

- OD** ON when the door is closed
 - OT** Bolt tongue inserted in the evaluation module
 - OL** Guard locking solenoid in locked position
 - OI** Diagnostics; there is a fault
-

Pushbutton

- S2** 1 NO contact, illuminated
 - S3** 1 NO contact, illuminated
-

Lens set

The color of the pushbutton can be selected using the lens set included (6 colors). Item no.: 120378 (see Accessories)

Adhesive labels

Devices with adhesive labels have pre-formed recesses. The adhesive labels enclosed (standard size 12.5 x 27 mm) can be affixed in these recesses.

Escape release

The escape release enables persons who are accidentally locked in to open the locked door from inside the danger area.

Components included in the set



121088 Locking module MGB-L1-ARA-AL2A1-M-L-121088
✓ Features



106619 Handle module MGB-H-AA1A1-L-106619
✓ Features



100465 Escape release MGB-E-A-100465
✓ Features



120378 AY-SET-LNS-0002-120378
✓ Features

Dimension drawing

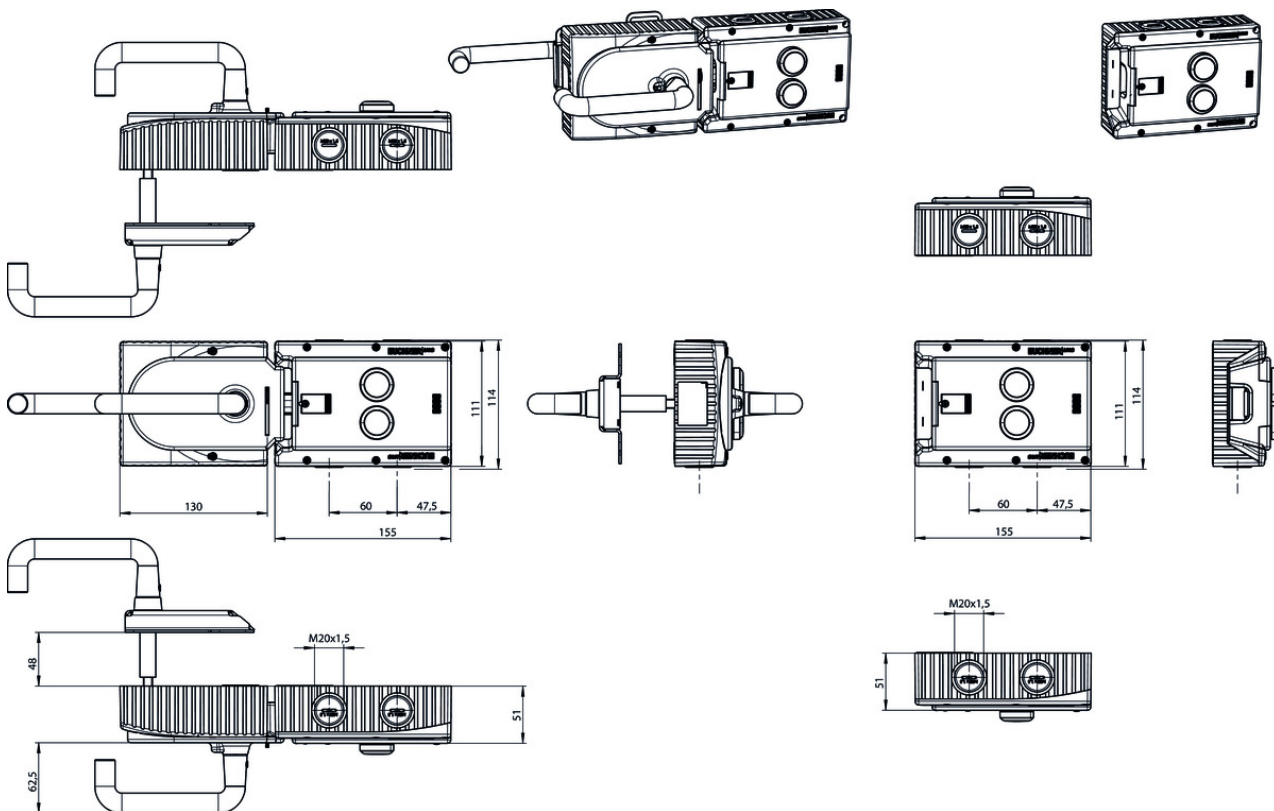

Cable entry

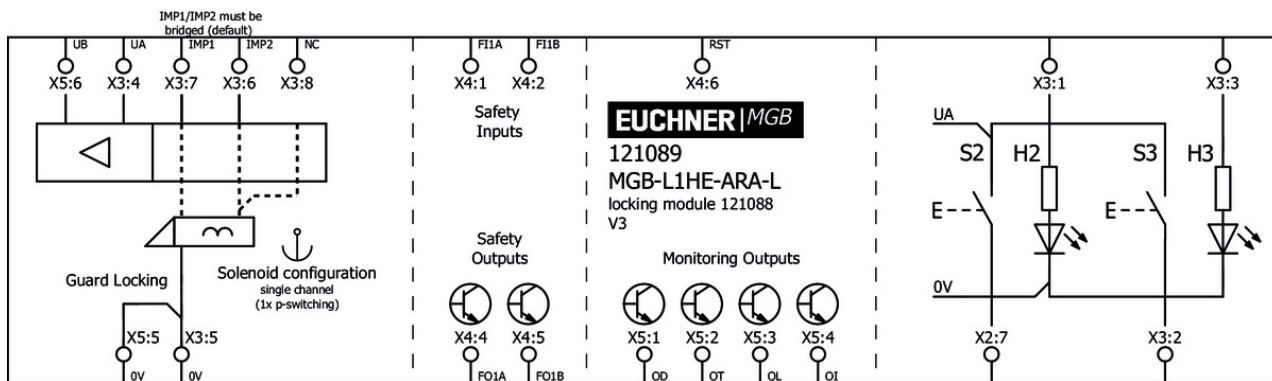

Function expansion

Escape release MGB-E-A...



100465 MGB-E-A-100465

Features

- › Escape release from the danger zone
- › Door handle signal red
- › Extended actuation axis for thicker doors (available optionally)

Door knob for MGB-H...

111460 MGB-A-DOORKNOB-S1-111460



✓ Features

- › Aluminum, silver anodized
 - › For mounting on all MGB handle modules MGB-H... up to V2.0.0
 - › e.g. on sliding doors
-



124030 MGB-A-DOORKNOB-S2-124030

✓ Features

- › Aluminum, silver anodized
 - › For mounting on all MGB handle modules MGB-H... from V3.0.0
 - › e.g. on sliding doors
-

✓ Emergency unlocking for safety system MGB



112989 MGB-A-EMERGENCYRELEASE-112989

✓ Features

- › Quick emergency unlocking
 - › sealable
-

✓ Door handle for MGB-E...



110276 MGB-A-DOORHANDLE-R1-110276

✓ Features

- › Aluminum, red painted
 - › For mounting on all MGB escape release modules MGB-E
-

✓ Door knob for MGB-E...



114904 MGB-A-DOORKNOB-R1-114904

✓ Features

- › Aluminum, red painted
 - › For mounting on all MGB escape release modules MGB-E
 - › e.g. on sliding doors
-

✓ Door handle for MGB-H...



123926 MGB-A-DOORHANDLE-S2-123926

✓ Features

- › Aluminum silver anodized
 - › For mounting on all MGB handle modules MGB-H from V3.0.0
-



110277 MGB-A-DOORHANDLE-S1-110277

✓ Features

- › Aluminum silver anodized
 - › For mounting on all MGB handle modules MGB-H up to V2.0.0
-

✓ Extended actuation axis for MGB-E...



106761 AY-ERS-250-106761

Spare parts

▼ Handle module MGB-H...



106619 MGB-H-AA1A1-L-106619

▼ Features

- › Intelligent bolt tongue
 - › Lockout bar
 - › Door handle
-

▼ Locking module MGB-L1-ARA..., (guard locking by spring force) with 2 push buttons, incl. label carrier



121088 MGB-L1-ARA-AL2A1-M-L-121088

▼ Features

- › Guard locking with guard lock monitoring
 - › Can be connected in series with other AR devices (e.g. CES-AR and CET-AR)
 - › 2 pushbuttons (illuminated)
 - › With lens set, 6 pcs.
 - › Incl. adhesive labels
 - › With cable entry
 - › Unicode
-

Mounting accessories

▼ Mounting plate for evaluation modules MGB-L.-AR.-... and MGB-L.-AP.-...



109490 MGB-A-MOUNTINGPLATE-L-109490

▼ Features

- › Easy and quick mounting (only two screws required)
 - › Quick module replacement
 - › Steel, powder-coated
 - › Suitable for doors hinged on the right or left
-

▼ Mounting plate for all MGB handle modules



109491 MGB-A-MOUNTINGPLATE-H-109491

▼ Features

- › Easy and quick mounting (only two screws required)
 - › Quick module replacement
 - › Steel, powder-coated
 - › Suitable for doors hinged on the right or left
-

▼ Mounting plate for escape release



109492 MGB-A-MOUNTINGPLATE-E-109492

▼ Features

- › Easy and quick mounting (only two screws required)
- › Quick module replacement

- › Steel, powder-coated
- › Suitable for doors hinged on the right or left

Miscellaneous accessories

▼ Lens set 5 colors



120344 AY-SET-LNS-0001-120344

▼ Lens set labeled



120377 AY-SET-LNS-SY01-120377



125359 AY-SET-LNS-SY02-125359



126158 AY-SET-LNS-SY03-126158

▼ Lens set 6 colors



120378 AY-SET-LNS-0002-120378

▼ Adhesive labels

114529 MGB-A-PLATESET-NN01-114529

▼ Features

- › Adhesive labels suitable for MGB evaluation modules, bus modules and control modules
- › silver, blank
- › Packaging unit = 10 pcs.

▼ Lens set, three colors



158307 AY-SET-LNS-SY04-158307

Connection material

▼ Built-in connector RC18

120403 MGB-A-PLUGCONNECTOR-RC18-120403

▼ Features

- › For all MGB with cable entry
-

Instructions

- ☑ Návod k použití – bezpečnostní systémy MGB-L1...AR-... / MGB-L2...AR-... a MGB-L1...AP-... / MGB-L2...AP-... od V3.0.0

| | Doc. no. | Version | Language | Download |
|---|----------|----------|---|--|
| Betriebsanleitung MGB-L1...AR-... / MGB-L2...AR-... und MGB-L1...AP-... / MGB-L2...AP-... ab V3.0.0 | 2119167 | 04-05/18 |  |  3.7 MB |
| Mode d'emploi MGB-L1...AR-... / MGB-L2...AR-... et MGB-L1...AP-... / MGB-L2...AP-... à partir de V3.0.0 | 2119167 | 04-05/18 |  |  3.7 MB |
| Manual de instrucciones MGB-L1...AR-... / MGB-L2...AR-... y MGB-L1...AP-... / MGB-L2...AP-... V3.0.0 o superior | 2119167 | 04-05/18 |  |  3.7 MB |
| Návod k použití – bezpečnostní systémy MGB-L1...AR-... / MGB-L2...AR-... a MGB-L1...AP-... / MGB-L2...AP-... od V3.0.0 | 2119167 | 04-05/18 |  |  4.0 MB |
| Operating Instructions MGB-L1...AR-... / MGB-L2...AR-... and MGB-L1...AP-... / MGB-L2...AP-... from V3.0.0 | 2119167 | 04-05/18 |  |  3.7 MB |
| Istruzioni di impiego MGB-L1...AR-... / MGB-L2...AR-... und MGB-L1...AP-... / MGB-L2...AP-... da V3.0.0 | 2119167 | 04-05/18 |  |  3.7 MB |
| Handleiding MGB-L1...AR-... / MGB-L2...AR-... en MGB-L1...AP-... / MGB-L2...AP-... vanaf V3.0.0 | 2119167 | 04-05/18 |  |  3.7 MB |
| Instrukcja obsługi MGB-L1...AR-... / MGB-L2...AR-... i MGB-L1...AP-... / MGB-L2...AP-... od V3.0.0 | 2119167 | 04-05/18 |  |  4.0 MB |
| Manual de instruções MGB-L1...AR-... / MGB-L2...AR-... e MGB-L1...AP-... / MGB-L2...AP-... a partir de V3.0.0 | 2119167 | 04-05/18 |  |  3.7 MB |
| Инструкция по эксплуатации MGB-L1...AR-... / MGB-L2...AR-... и MGB-L1...AP-... / MGB-L2...AP-... с V3.0.0 | 2119167 | 04-05/18 |  |  4.2 MB |
| Návod na prevádzku Bezpečnostné systémy MGB-L1...AR-... / MGB-L2...AR-... a MGB-L1...AP-... / MGB-L2...AP-... od V3.0.0 | 2119167 | 04-05/18 |  |  4.0 MB |
| Instruktionsbok MGB-L1...AR-... / MGB-L2...AR-... och MGB-L1...AP-... / MGB-L2...AP-... fr. V3.0.0 | 2119167 | 04-05/18 |  |  3.7 MB |
| İşletim kılavuzu MGB-L1...AR-... / MGB-L2...AR-... ve MGB-L1...AP-... / MGB-L2...AP-... itibaren V3.0.0 | 2119167 | 04-05/18 |  |  4.1 MB |
| 操作指示書 安全システム MGB-L1...AR-... / MGB-L2...AR-... および MGB-L1...AP-... / MGB-L2...AP-... V3.0.0以降 | 2119167 | 04-05/18 |  |  4.1 MB |
| 使用说明书 安全系统 MGB-L1...AR-... / MGB-L2...AR-... 和 MGB-L1...AP-... / MGB-L2...AP-... V3.0.0 以上 | 2119167 | 04-05/18 |  |  4.1 MB |

✓ Sicherheitsinformation (Teil der Betriebsanleitung Sicherheitssystem MGB-AR/MGB-AP) ab V3.0.0

| | Doc. no. | Version | Language | Download |
|---|----------|----------|----------------------|----------|
| Sicherheitsinformation (Teil der Betriebsanleitung Sicherheitssystem MGB-AR/MGB-AP) ab V3.0.0 Información de seguridad (parte del manual de instrucciones Sistema de seguridad MGB-AR/MGB-AP) V3.0.0 o superior Information de sécurité (partie du mode d'emploi Système de sécurité MGB-AR/MGB-AP) à partir de V3.0.0 Informazioni sulla sicurezza (Parte delle istruzioni di impiego Sistema di sicurezza MGB-AR/MGB-AP) da V3.0.0 Säkerhetsinformation (Del av instruktionsboken Säkerhetssystem MGB-AR/MGB-AP) från V3.0.0 Safety Information (Part of the Operating Instructions Safety System MGB-AR/MGB-AP) from V3.0.0 | 123151 | 01-02/15 | | 0.6 MB |
| Veiligheidsinformatie (Deel van de handleiding Beveiligingssysteem MGB-AR/MGB-AP) vanaf V3.0.0 | 123151 | 01-02/15 | | 0.2 MB |
| Informação de segurança (Parte do manual de instruções Sistema de segurança MGB-AR/MGB-AP) a partir de V3.0.0 | 123151 | 01-02/15 | | 0.2 MB |
| Bezpečnostní informace (součást návodu k použití „Bezpečnostní systém MGB-AR/MGB-AP“) od V3.0.0 | 123151 | 01-02/15 | | 0.2 MB |
| Informacje o bezpieczeństwie (Część instrukcji obsługi System bezpieczeństwa MGB-AR/MGB-AP) od V3.0.0 | 123151 | 01-02/15 | | 0.2 MB |
| Информация о безопасности (часть инструкции по эксплуатации Предохранительная система MGB-AR/MGB-AP) с V3.0.0 | 123151 | 01-02/15 | | 0.3 MB |
| Bezpečnostná informácia (časť návodu na prevádzku Bezpečnostný systém MGB-AR/MGB-AP) od V3.0.0 | 123151 | 01-02/15 | | 0.2 MB |
| Güvenlik bilgisi (İşletim kılavuzunun parçası emniyet sistemi MGB-AR/MGB-AP) V3.0.0 ve üstü | 123151 | 01-02/15 | | 0.3 MB |
| 安全信息 (安全系统 MGB-AR/MGB-AP使用说明书的组成部分) V3.0.0以上 | 123151 | 01-02/15 | | 0.3 MB |
| 安全情報 MGB-AR/MGB-AP | 123151 | 01-02/15 | | 0.6 MB |

Catalogs







✓ Multifunctional Gate Box MGB Multifunctional Gate Box MGB Multifunctional Gate Box MGB Multifunctional Gate Box MGB 多功能系统安全控制系统 MGB

| | Doc. no. | Version | Language | Download |
|------------------------------|----------|----------|----------|----------|
| Multifunctional Gate Box MGB | 106108 | 10-02/18 | | 8.2 MB |

| | | | | |
|------------------------------|--------|----------|---|--|
| Multifunctional Gate Box MGB | 109155 | 10-02/18 |  |  8.2 MB |
| Multifunctional Gate Box MGB | 114433 | 10-02/18 |  |  8.3 MB |
| Multifunctional Gate Box MGB | 121652 | 10-02/18 |  |  8.0 MB |
| Multifunctional Gate Box MGB | 106109 | 10-02/18 |  |  8.2 MB |
| 多功能系统安全控制系统 MGB | 155883 | 10-02/18 |  |  8.3 MB |

Declaration of conformity

EU-Konformitätserklärung

| | Doc. no. | Version | Language | Download |
|-------------------------------|----------|----------|---|--|
| EU-Konformitätserklärung | 2123150 | 08-01/17 |  |  0.3 MB |
| Declaración UE de conformidad | | |  | |
| Déclaration UE de conformité | | |  | |
| Dichiarazione di conformità | | |  | |
| EU declaration of conformity | | |  | |

CAD data

CAD data for this item on TraceParts