

ITEM 121253 MGB-L0-ARA-AM3A1-M-R-121253

| Description | Technical data | Accessories | Downloads |
|-------------|----------------|-------------|-----------|
|-------------|----------------|-------------|-----------|

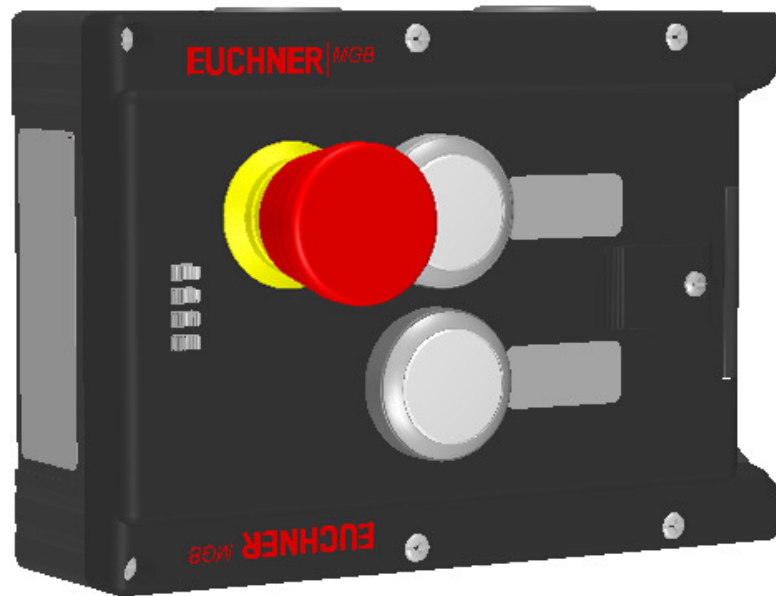

Features

- › Locking (without guard locking)
- › Can be connected in series with other AR devices (e.g. CES-AR and CET-AR)
- › Emergency stop according to ISO 13850
- › 2 pushbuttons (illuminated)
- › With lens set, 6 pcs.
- › Incl. adhesive labels
- › With cable entry
- › Unicode

Guard locking type

MGB- The bolt tongue in the handle module is moved into and out of the **LO...** interlocking module by actuating the door handle. The door arm is not locked in the locked position.

Door hinge

A mechanical door stop is permanently integrated into the evaluation module of the MGB. A marking on the stop makes adjustment easier.

LED indicator

The LED indicator indicates all important system and status information.

Monitoring outputs

- OD** ON when the door is closed
 - OT** Bolt tongue inserted in the evaluation module
 - OI** Diagnostics; there is a fault
-

Emergency stop device

- S1** 2 positively driven NC contacts and 1 NO contact (e.g. monitoring contact), emergency stop with turn-to-reset, not illuminated
-

Pushbutton

- S2** 1 NO contact, illuminated
 - S3** 1 NO contact, illuminated
-

Lens set

The color of the pushbutton can be selected using the lens set included (5 colors). Item no.: 120344 (see Accessories)

Adhesive labels

Devices with adhesive labels have pre-formed recesses. The adhesive labels enclosed (standard size 12.5 x 27 mm) can be affixed in these recesses.

Approvals



Mechanical values and environment

| | |
|--|--|
| Housing material | Reinforced plastic; die-cast zinc nickel-plated, stainless steel |
| Weight | Net 0,75 kg |
| Ambient temperature | At $U_B = 24V$ DC -20 ... 55 °C |
| Degree of protection | IP65 |
| Mechanical life | 1×10^6 |
| In case of use as door stop, and 1 Joule impact energy | $0,1 \times 10^6$ |

| | |
|-----------------------|-----------------------|
| Installation position | Door hinge DIN right |
| Switching frequency | 0,25 Hz |
| Connection | Cable entries M20x1.5 |

Electrical connection ratings

| | | |
|--|----------|---|
| Utilization category according to EN 60947-5-2 | DC-13 | 24V 200mA ^[1] |
| Rated insulation voltage U_i | | 30 V |
| Rated impulse withstand voltage U_{imp} | | 1,5 kV |
| Degree of contamination (external, according to EN 60947-1) | | 3 |
| Connection cross-section | | |
| (Rigid/flexible) | | 0,13 ... 1,5 mm ² |
| (Rigid/flexible) with cable end sleeve according to DIN 46 228/1 | | 0,25 ... 1,5 mm ² |
| (Rigid/flexible) with cable end sleeve with collar according to DIN 46 228/1 | | 0,25 ... 0,75 mm ² |
| Safety class | | III |
| Discrepancy time | | |
| Between FO1A and FO1B | | max.10 ms |
| Risk time according to EN 60947-5-3 | | max.350 ms |
| Transponder coding | | Unicode |
| Power supply U_B | | |
| Operating voltage DC | U_B | 24 V DC -15% ... 10% ^[2] |
| Current consumption | I_{UB} | max.80 mA ^[3] |
| Power supply U_A | | |
| Operating voltage DC | U_A | 24 V DC -15% ... 10% ^[4] |
| Current consumption | I_{UA} | max.10 mA ^[5] |
| Safety outputs FO1A, FO1B | | |
| Test pulses | | max.1 ms |
| Test-pulse interval | | min.100 ms |
| Type of output | | Semiconductor outputs, p-switching, short circuit-proof |
| Output voltage | | |
| U_{FO1A} / U_{FO1B} HIGH | | $U_B - 2V \dots U_B$ V DC ^[6] |
| U_{FO1A} / U_{FO1B} LOW | | 0 ... 1 V DC |
| Output current | | |
| Per safety output FO1A / FO1B | | 1 ... 200 mA |
| Monitoring outputs OD, OT, OL, OI | | |
| Type of output | | Semiconductor outputs, p-switching, short circuit-proof |
| Output voltage | | $U_A - 2V \dots U_A$ V DC ^[7] |
| Output current | | max.50 mA |

| | |
|-------------------|--------------------------------|
| | Controls and indicators |
| Switching voltage | U _A V |
| Switching current | 1 ... 10 mA |
| Breaking capacity | max.0,25 W |
| Power supply LED | 24 V DC |
| | Emergency stop |
| Switching voltage | 5 ... 24 V |
| Switching current | 1 ... 100 mA |
| Breaking capacity | max.0,25 W |
| Power supply LED | 24 V DC |

Controls and indicators

| | |
|--------------------|--------------------------|
| Assignment diagram | L1 |
| Control/indicator | |
| | Position 1 |
| Version | Emergency stop |
| Special features | With auxiliary contact |
| Color | |
| Switching element | 2 pos. driven NC + 1NO |
| Slide-in label | |
| Control/indicator | |
| | Position 2 |
| Version | Illuminated push buttons |
| Special features | |
| Color | |
| Switching element | 1NO |
| Slide-in label | |
| Control/indicator | |
| | Position 3 |
| Version | Illuminated push buttons |
| Special features | |
| Color | |
| Switching element | 1NO |
| Slide-in label | |

Miscellaneous

| | |
|------------------------|--------------------------------|
| Additional feature | Incl. cover set ID. No. 120344 |
| Product version number | V3.0.3 |
| Slide-in label | 2 pcs. without marking |

Reliability values acc. to EN ISO 13849-1

| | |
|--|---|
| | Monitoring of the position of the safety guard |
|--|---|

| | |
|-------------------|-----------------------|
| Category | 4 |
| Performance Level | PL e |
| PFH _D | 3.7×10^{-9} |
| | Emergency stop |
| B10 _D | |
| Emergency stop | $0,065 \times 10^6$ |

| | |
|--------------|------|
| Mission time | 20 y |
|--------------|------|

- [1] Caution: outputs must be protected with a free-wheeling diode in case of inductive loads.
- [2, 4] (Reverse polarity protected, regulated, residual ripple <5%, PELV)
- [3] (no load on outputs)
- [5] (With no load on outputs OD, OT, OL, OI)
- [6, 7] Value at a switching current of 50mA without taking into account the cable lengths

Dimension drawing

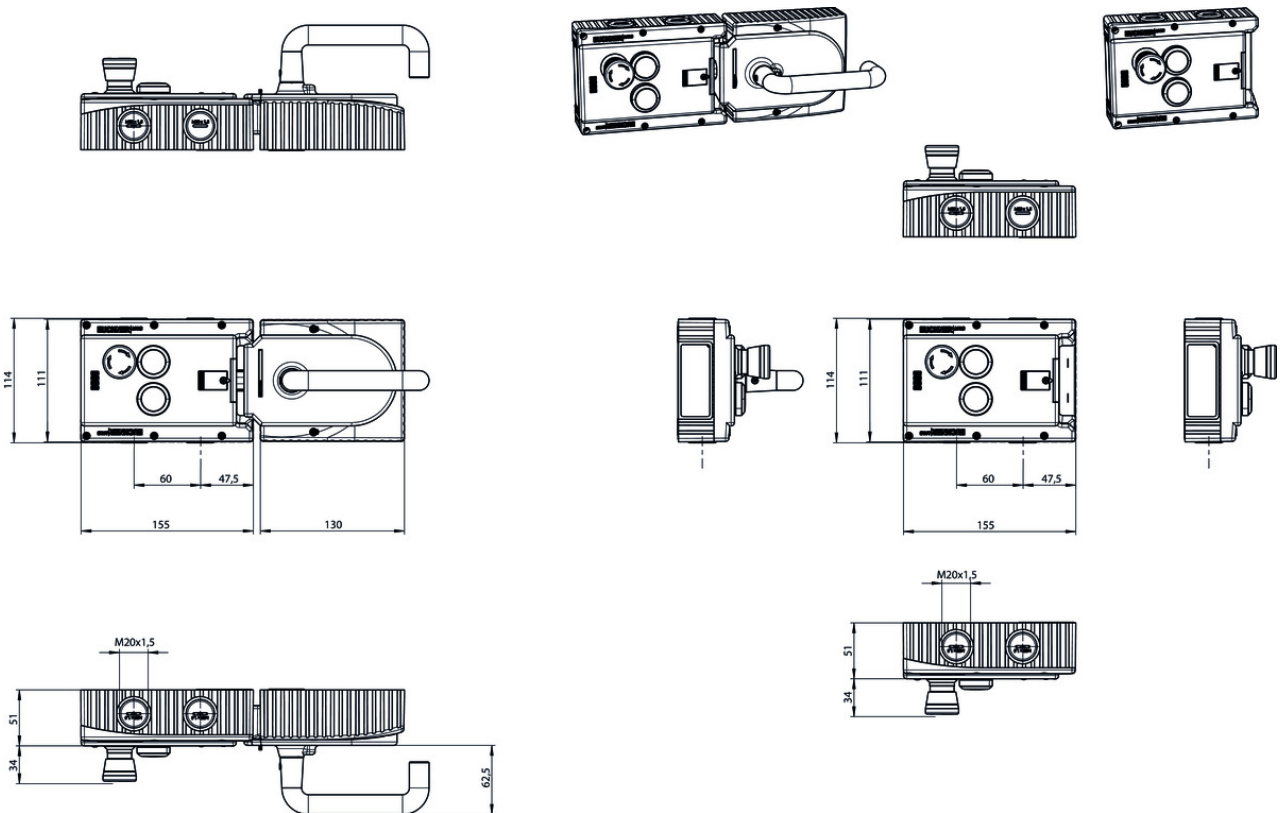

Cable entry

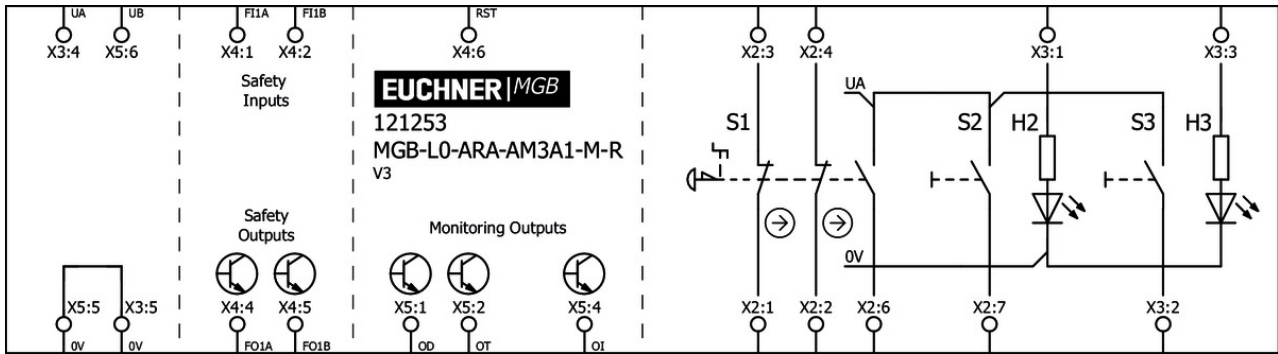

Miscellaneous accessories

✓ Lens set 5 colors



120344 AY-SET-LNS-0001-120344

✓ Lens set 6 colors



120378 AY-SET-LNS-0002-120378

✓ Lens set labeled



120377 AY-SET-LNS-SY01-120377



125359 AY-SET-LNS-SY02-125359



126158 AY-SET-LNS-SY03-126158

✓ Adhesive labels

114529 MGB-A-PLATESET-NN01-114529

✓ Features

- › Adhesive labels suitable for MGB evaluation modules, bus modules and control modules
- › silver, blank
- › Packaging unit = 10 pcs.

✓ Lens set, three colors



158307 AY-SET-LNS-SY04-158307

Connection material

▼ Built-in connector RC18

120403 MGB-A-PLUGCONNECTOR-RC18-120403

▼ Features

- › For all MGB with cable entry

▼ Cable glands M20x1.5



086233 EKPM20/06 086233

Mounting accessories

▼ Mounting plate for evaluation modules MGB-L.-AR.-... and MGB-L.-AP.-...



109490 MGB-A-MOUNTINGPLATE-L-109490

▼ Features

- › Easy and quick mounting (only two screws required)
- › Quick module replacement
- › Steel, powder-coated
- › Suitable for doors hinged on the right or left

Function expansion

▼ Emergency unlocking for safety system MGB



112989 MGB-A-EMERGENCYRELEASE-112989



















▼ Features

- › Quick emergency unlocking
- › sealable















Instructions









▼ Návod k použití – bezpečnostní systémy MGB-L0...AR.-... a MGB-L0...AP.-... od V3.0.0

| | Doc. no. | Version | Language | Download |
|---|----------|----------|----------|----------|
| Betriebsanleitung MGB-L0...AR.-... und MGB-L0...AP.-... ab V3.0.0 | 2112657 | 13-05/18 | | 2.9 MB |
| Mode d'emploi MGB-L0...AR.-... et MGB-L0...AP.-... à partir de V3.0.0 | 2112657 | 13-05/18 | | 3.0 MB |
| Manual de instrucciones MGB-L0...AR.-... y MGB-L0...AP.-... V3.0.0 o superior | 2112657 | 13-05/18 | | 2.9 MB |

| | | | | |
|--|---------|----------|---|--|
| Návod k použití – bezpečnostní systémy MGB-L0...-AR-... a MGB-L0...-AP-... od V3.0.0 | 2112657 | 13-05/18 |  |  3.2 MB |
| Operating Instructions MGB-L0...AR-... and MGB-L0...AP-... from V3.0.0 | 2112657 | 13-05/18 |  |  2.9 MB |
| Istruzioni di impiego per MGB-L0...AR-... e MGB-L0...AP-... da V3.0.0 | 2112657 | 13-05/18 |  |  2.9 MB |
| Instrukcja obsługi MGB-L0...AR-... i MGB-L0...AP-... od V3.0.0 | 2112657 | 13-05/18 |  |  3.2 MB |
| Manual de instruções MGB-L0...AR-... e MGB-L0...AP-... a partir de V3.0.0 | 2112657 | 13-05/18 |  |  2.9 MB |
| Инструкция по эксплуатации MGB-L0...AR-... и MGB-L0...AP-... с V3.0.0 | 2112657 | 13-05/18 |  |  3.4 MB |
| Instruktionsbok MGB-L0...AR-... och MGB-L0...AP-... fr. V3.0.0 | 2112657 | 13-05/18 |  |  2.9 MB |
| 操作指示書 安全システム MGB-L0...-AR-... および MGB-L0...-AP-... V3.0.0以降 | 2112657 | 13-05/18 |  |  3.3 MB |
| 使用说明书 安全系统 MGB-L0...-AR-...和MGB-L0...-AP-... V3.0.0以上 | 2112657 | 13-05/18 |  |  3.3 MB |







 **Sicherheitsinformation (Teil der Betriebsanleitung Sicherheitssystem MGB-AR/MGB-AP) ab V3.0.0**

| | Doc. no. | Version | Language | Download |
|---|-----------------|----------------|--|--|
| Sicherheitsinformation (Teil der Betriebsanleitung Sicherheitssystem MGB-AR/MGB-AP) ab V3.0.0 Información de seguridad (parte del manual de instrucciones Sistema de seguridad MGB-AR/MGB-AP) V3.0.0 o superior Information de sécurité (partie du mode d'emploi Système de sécurité MGB-AR/MGB-AP) à partir de V3.0.0 Informazioni sulla sicurezza (Parte delle istruzioni di impiego Sistema di sicurezza MGB-AR/MGB-AP) da V3.0.0 Säkerhetsinformation (Del av instruktionsboken Säkerhetssystem MGB-AR/MGB-AP) från V3.0.0 Safety Information (Part of the Operating Instructions Safety System MGB-AR/MGB-AP) from V3.0.0 | 123151 | 01-02/15 |       |  0.6 MB |
| Veiligheidsinformatie (Deel van de handleiding Beveiligingssysteem MGB-AR/MGB-AP) vanaf V3.0.0 | 123151 | 01-02/15 |  |  0.2 MB |
| Informação de segurança (Parte do manual de instruções Sistema de segurança MGB-AR/MGB-AP) a partir de V3.0.0 | 123151 | 01-02/15 |  |  0.2 MB |
| Bezpečnostní informace (součást návodu k použití „Bezpečnostní systém MGB-AR/MGB-AP“) od V3.0.0 | 123151 | 01-02/15 |  |  0.2 MB |
| Informacje o bezpieczeństwie (Część instrukcji obsługi System bezpieczeństwa MGB-AR/MGB-AP) od V3.0.0 | 123151 | 01-02/15 |  |  0.2 MB |

| | | | | |
|---|--------|----------|---|--|
| Информация о безопасности (часть инструкции по эксплуатации Предохранительная система MGB-AR/MGB-AP) с V3.0.0 | 123151 | 01-02/15 |  |  0.3 MB |
| Bezpečnostná informácia (časť návodu na prevádzku Bezpečnostný systém MGB-AR/MGB-AP) od V3.0.0 | 123151 | 01-02/15 |  |  0.2 MB |
| Güvenlik bilgisi (İşletim kılavuzunun parçası emniyet sistemi MGB-AR/MGB-AP) V3.0.0 ve üstü | 123151 | 01-02/15 |  |  0.3 MB |
| 安全信息 (安全系统 MGB-AR/MGB-AP使用说明书的组成部分) V3.0.0以上 | 123151 | 01-02/15 |  |  0.3 MB |
| 安全情報 MGB-AR/MGB-AP | 123151 | 01-02/15 |  |  0.6 MB |

Declaration of conformity

EU-Konformitätserklärung

| | Doc. no. | Version | Language | Download |
|--|----------|----------|---|--|
| EU-Konformitätserklärung Declaración UE de conformidad Déclaration UE de conformité Dichiarazione di conformità EU declaration of conformity | 2123150 | 08-01/17 |      |  0.3 MB |