

ITEM 121509 MGB-L1H-ARA-R-121509

| Description | Technical data | Accessories | Downloads |
|-------------|----------------|-------------|-----------|
|-------------|----------------|-------------|-----------|

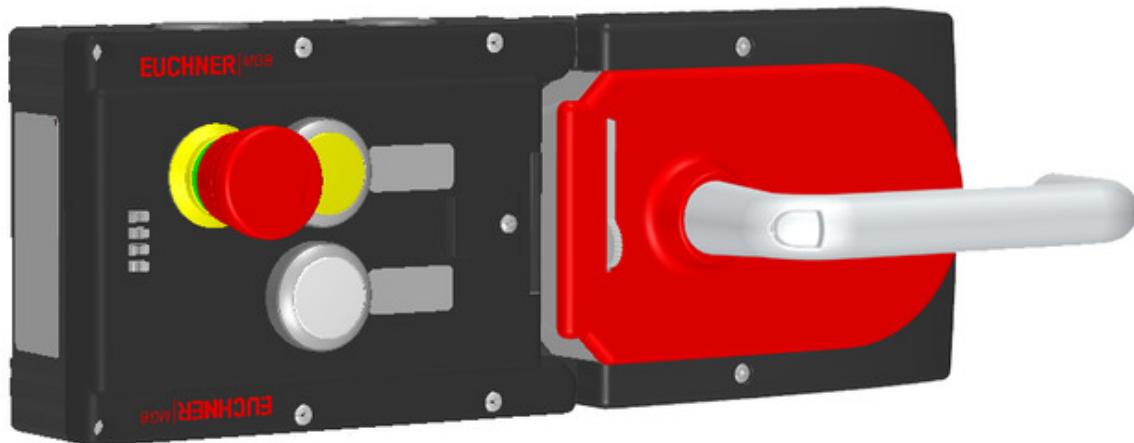

Features

- › Guard locking with guard lock monitoring
- › Can be connected in series with other AR devices (e.g. CES-AR and CET-AR)
- › Emergency stop according to ISO 13850
- › 2 pushbuttons (illuminated)
- › With lens set, 6 pcs.
- › Incl. adhesive labels
- › With cable entry
- › Unicode

Guard locking type

MGB- The locking arm is held in the locked position by spring force and is
L1... unlocked by solenoid force (closed-circuit current principle, mechanically locked).

Door hinge

A mechanical door stop is permanently integrated into the evaluation module of the MGB. A marking on the stop makes adjustment easier.

LED indicator

The LED indicator indicates all important system and status information.

Monitoring outputs

- OD** ON when the door is closed
 - OT** Bolt tongue inserted in the evaluation module
 - OL** Guard locking solenoid in locked position
 - OI** Diagnostics; there is a fault
-

Emergency stop device

- S1** 2 positively driven NC contacts and 1 NO contact (e.g. monitoring contact), emergency stop with turn-to-reset, not illuminated
-

Pushbutton

- S2** 1 NO contact, illuminated
 - S3** 1 NO contact, illuminated
-

Lens set

The color of the pushbutton can be selected using the lens set included (5 colors). Item no.: 120344 (see Accessories)

Adhesive labels

Devices with adhesive labels have pre-formed recesses. The adhesive labels enclosed (standard size 12.5 x 27 mm) can be affixed in these recesses.

Components included in the set

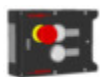

- 121255 Locking module MGB-L1-ARA-AM3A1-M-R-121255
 - Features
-



- 111157 Handle module MGB-H-AA1A3-R-111157
 - Features
-

Dimension drawing

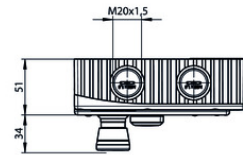
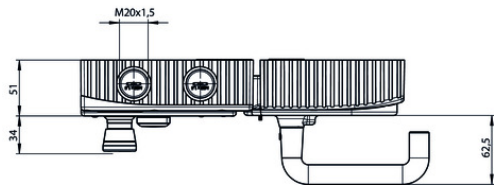
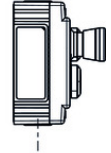
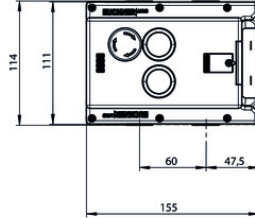
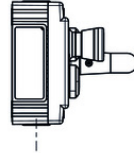
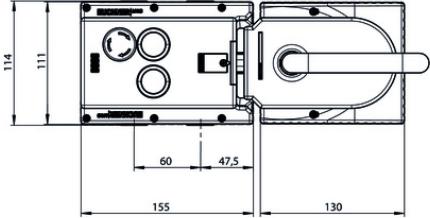
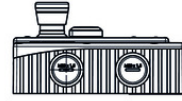
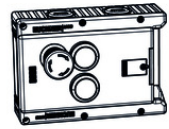
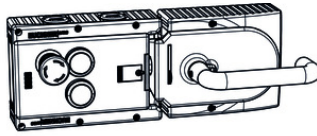
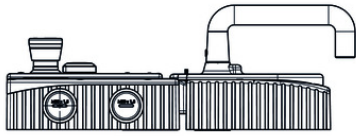

Dimension drawing

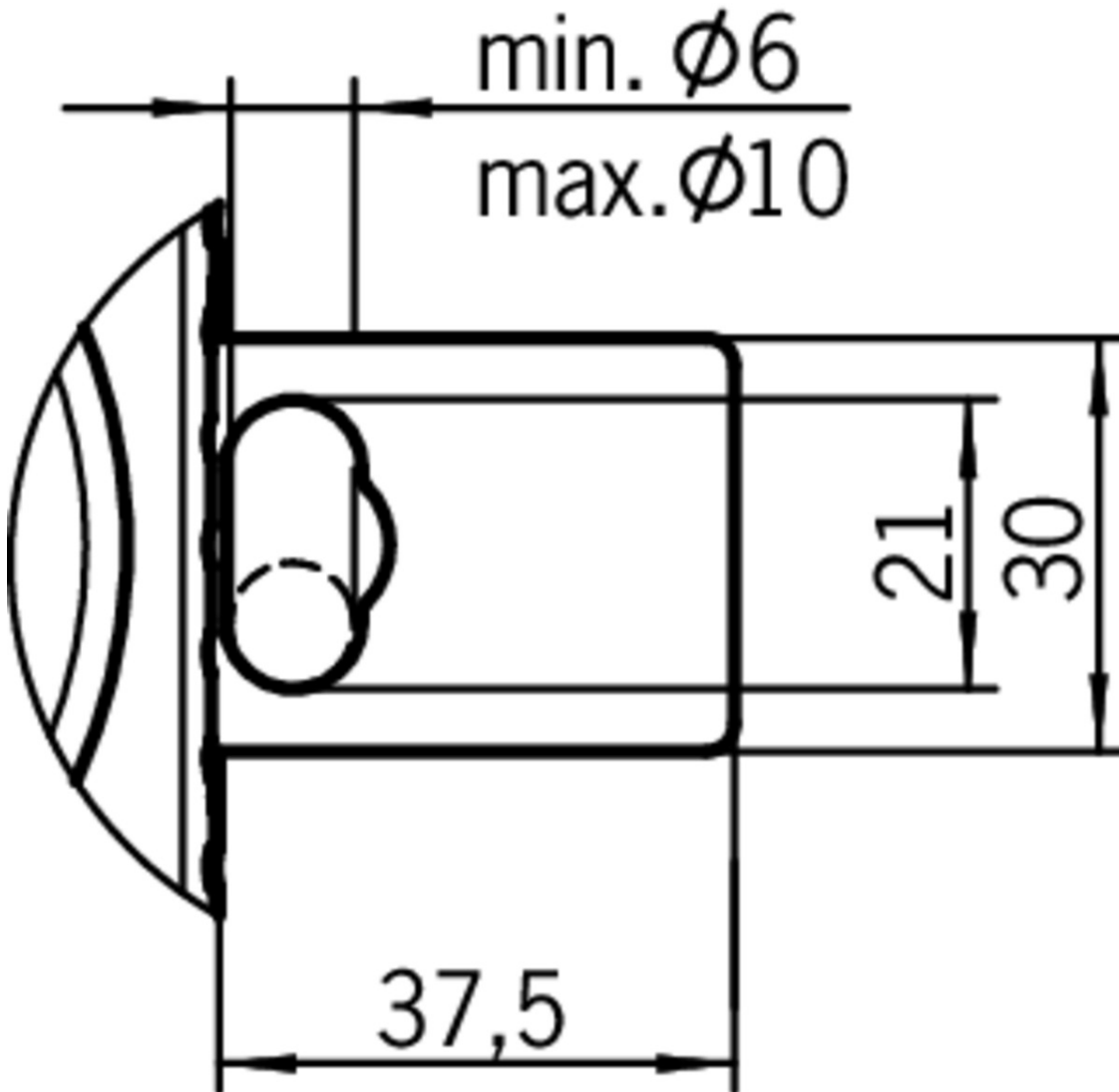

Cable entry

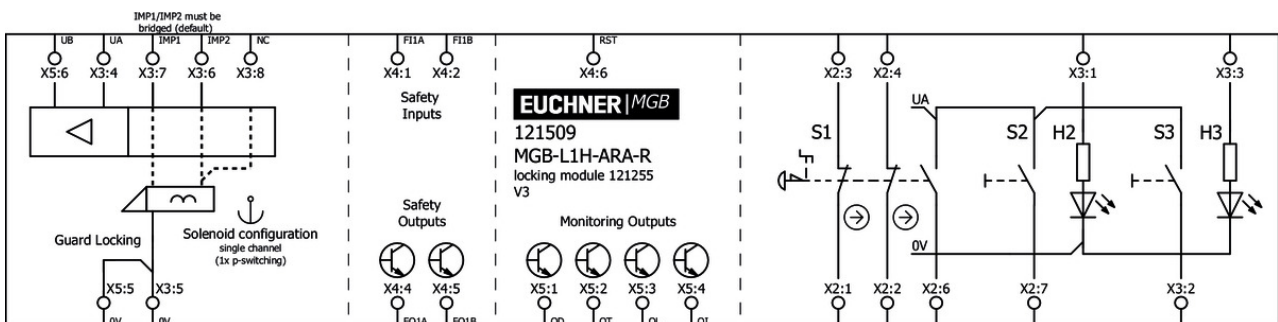

Spare parts

- ✓ Locking module MGB-L1-ARA..., (guard locking by spring force) with 2 push buttons, emergency stop, incl. label carrier



121255 MGB-L1-ARA-AM3A1-M-R-121255

- ✓ Features

- › Guard locking with guard lock monitoring

- › Can be connected in series with other AR devices (e.g. CES-AR and CET-AR)
 - › Emergency stop according to ISO 13850
 - › 2 pushbuttons (illuminated)
 - › With lens set, 6 pcs.
 - › Incl. adhesive labels
 - › With cable entry
 - › Unicode
-

▼ Handle module MGB-H...



111157 MGB-H-AA1A3-R-111157

▼ Features

- › Intelligent bolt tongue
 - › Fold-out lockout mechanism
 - › Second automatically extending lockout mechanism
 - › Door handle
-

Function expansion

▼ Escape release MGB-E-A...



100465 MGB-E-A-100465

▼ Features

- › Escape release from the danger zone
 - › Door handle signal red
 - › Extended actuation axis for thicker doors (available optionally)
-

▼ Door knob for MGB-H...



111460 MGB-A-DOORKNOB-S1-111460

▼ Features

- › Aluminum, silver anodized
 - › For mounting on all MGB handle modules MGB-H... up to V2.0.0
 - › e.g. on sliding doors
-



124030 MGB-A-DOORKNOB-S2-124030

▼ Features

- › Aluminum, silver anodized
 - › For mounting on all MGB handle modules MGB-H... from V3.0.0
 - › e.g. on sliding doors
-

▼ Door handle for MGB-H...



110277 MGB-A-DOORHANDLE-S1-110277

▼ Features

- › Aluminum silver anodized
 - › For mounting on all MGB handle modules MGB-H up to V2.0.0
-

123926 MGB-A-DOORHANDLE-S2-123926



▼ Features

- › Aluminum silver anodized
 - › For mounting on all MGB handle modules MGB-H from V3.0.0
-

▼ Emergency unlocking for safety system MGB



112989 MGB-A-EMERGENCYRELEASE-112989

▼ Features

- › Quick emergency unlocking
 - › sealable
-

Mounting accessories

▼ Mounting plate for evaluation modules MGB-L.-AR.-... and MGB-L.-AP.-...



109490 MGB-A-MOUNTINGPLATE-L-109490

▼ Features

- › Easy and quick mounting (only two screws required)
 - › Quick module replacement
 - › Steel, powder-coated
 - › Suitable for doors hinged on the right or left
-

▼ Mounting plate for all MGB handle modules



109491 MGB-A-MOUNTINGPLATE-H-109491

▼ Features

- › Easy and quick mounting (only two screws required)
 - › Quick module replacement
 - › Steel, powder-coated
 - › Suitable for doors hinged on the right or left
-

Miscellaneous accessories

▼ Lens set 5 colors



120344 AY-SET-LNS-0001-120344

▼ Lens set 6 colors



120378 AY-SET-LNS-0002-120378

▼ Lens set labeled



120377 AY-SET-LNS-SY01-120377



125359 AY-SET-LNS-SY02-125359



126158 AY-SET-LNS-SY03-126158

Adhesive labels

114529 MGB-A-PLATESET-NN01-114529

Features

- › Adhesive labels suitable for MGB evaluation modules, bus modules and control modules
- › silver, blank
- › Packaging unit = 10 pcs.

Lens set, three colors



158307 AY-SET-LNS-SY04-158307

Connection material

Built-in connector RC18

120403 MGB-A-PLUGCONNECTOR-RC18-120403

Features

- › For all MGB with cable entry

Instructions



















Návod k použití – bezpečnostní systémy MGB-L1...AR.-... / MGB-L2...AR.-... a MGB-L1...AP.-... / MGB-L2...AP.-... od V3.0.0

| | Doc. no. | Version | Language | Download |
|--|----------|----------|----------|----------|
| Betriebsanleitung MGB-L1...AR.-... / MGB-L2...AR.-... und MGB-L1...AP.-... / MGB-L2...AP.-... ab V3.0.0 | 2119167 | 04-05/18 | | 3.7 MB |
| Mode d'emploi MGB-L1...AR.-... / MGB-L2...AR.-... et MGB-L1...AP.-... / MGB-L2...AP.-... à partir de V3.0.0 | 2119167 | 04-05/18 | | 3.7 MB |
| Manual de instrucciones MGB-L1...AR.-... / MGB-L2...AR.-... y MGB-L1...AP.-... / MGB-L2...AP.-... V3.0.0 o superior | 2119167 | 04-05/18 | | 3.7 MB |
| Návod k použití – bezpečnostní systémy MGB-L1...AR.-... / MGB-L2...AR.-... a MGB-L1...AP.-... / MGB-L2...AP.-... od V3.0.0 | 2119167 | 04-05/18 | | 4.0 MB |

| | | | | |
|---|---------|----------|--|--------|
| Operating Instructions MGB-L1...AR.-... / MGB-L2...AR.-... and MGB-L1...AP.-... / MGB-L2...AP.-... from V3.0.0 | 2119167 | 04-05/18 | | 3.7 MB |
| Istruzioni di impiego MGB-L1...AR.-... / MGB-L2...AR.-... und MGB-L1...AP.-... / MGB-L2...AP.-... da V3.0.0 | 2119167 | 04-05/18 | | 3.7 MB |
| Handleiding MGB-L1...AR.-... / MGB-L2...AR.-... en MGB-L1...AP.-... / MGB-L2...AP.-... vanaf V3.0.0 | 2119167 | 04-05/18 | | 3.7 MB |
| Instrukcja obsługi MGB-L1...AR.-... / MGB-L2...AR.-... i MGB-L1...AP.-... / MGB-L2...AP.-... od V3.0.0 | 2119167 | 04-05/18 | | 4.0 MB |
| Manual de instruções MGB-L1...AR.-... / MGB-L2...AR.-... e MGB-L1...AP.-... / MGB-L2...AP.-... a partir de V3.0.0 | 2119167 | 04-05/18 | | 3.7 MB |
| Инструкция по эксплуатации MGB-L1...AR.-... / MGB-L2...AR.-... и MGB-L1...AP.-... / MGB-L2...AP.-... с V3.0.0 | 2119167 | 04-05/18 | | 4.2 MB |
| Návod na prevádzku Bezpečnostné systémy MGB-L1...AR.-... / MGB-L2...AR.-... a MGB-L1...AP.-... / MGB-L2...AP.-... od V3.0.0 | 2119167 | 04-05/18 | | 4.0 MB |
| Instruktionsbok MGB-L1...AR.-... / MGB-L2...AR.-... och MGB-L1...AP.-... / MGB-L2...AP.-... fr. V3.0.0 | 2119167 | 04-05/18 | | 3.7 MB |
| İşletim kılavuzu MGB-L1...AR.-... / MGB-L2...AR.-... ve MGB-L1...AP.-... / MGB-L2...AP.-... itibaren V3.0.0 | 2119167 | 04-05/18 | | 4.1 MB |
| 操作指示書 安全システム MGB-L1...AR.-... / MGB-L2...AR.-... および MGB-L1...AP.-... / MGB-L2...AP.-... V3.0.0以降 | 2119167 | 04-05/18 | | 4.1 MB |
| 使用说明书 安全系统 MGB-L1...AR.-... / MGB-L2...AR.-... 和 MGB-L1...AP.-... / MGB-L2...AP.-... V3.0.0 以上 | 2119167 | 04-05/18 | | 4.1 MB |





Sicherheitsinformation (Teil der Betriebsanleitung Sicherheitssystem MGB-AR/MGB-AP) ab V3.0.0

| | Doc. no. | Version | Language | Download |
|---|-----------------|----------------|-----------------|-----------------|
| Sicherheitsinformation (Teil der Betriebsanleitung Sicherheitssystem MGB-AR/MGB-AP) ab V3.0.0 | 123151 | 01-02/15 | | 0.6 MB |
| Información de seguridad (parte del manual de instrucciones Sistema de seguridad MGB-AR/MGB-AP) V3.0.0 o superior | | | | |
| Information de sécurité (partie du mode d'emploi Système de sécurité MGB-AR/MGB-AP) à partir de V3.0.0 | | | | |
| Informazioni sulla sicurezza (Parte delle istruzioni di impiego Sistema di sicurezza MGB-AR/MGB-AP) da V3.0.0 | | | | |
| Säkerhetsinformation (Del av instruktionsboken Säkerhetssystem MGB-AR/MGB-AP) från V3.0.0 | | | | |
| Safety Information (Part of the Operating Instructions Safety System MGB-AR/MGB-AP) from V3.0.0 | | | | |

| | | | | |
|---|--------|----------|---|--|
| Veiligheidsinformatie (Deel van de handleiding Beveiligingssysteem MGB-AR/MGB-AP) vanaf V3.0.0 | 123151 | 01-02/15 |  |  0.2 MB |
| Informação de segurança (Parte do manual de instruções Sistema de segurança MGB-AR/MGB-AP) a partir de V3.0.0 | 123151 | 01-02/15 |  |  0.2 MB |
| Bezpečnostní informace (součást návodu k použití „Bezpečnostní systém MGB-AR/MGB-AP“) od V3.0.0 | 123151 | 01-02/15 |  |  0.2 MB |
| Informacje o bezpieczeństwie (Część instrukcji obsługi System bezpieczeństwa MGB-AR/MGB-AP) od V3.0.0 | 123151 | 01-02/15 |  |  0.2 MB |
| Информация о безопасности (часть инструкции по эксплуатации Предохранительная система MGB-AR/MGB-AP) с V3.0.0 | 123151 | 01-02/15 |  |  0.3 MB |
| Bezpečnostná informácia (časť návodu na prevádzku Bezpečnostný systém MGB-AR/MGB-AP) od V3.0.0 | 123151 | 01-02/15 |  |  0.2 MB |
| Güvenlik bilgisi (İşletim kılavuzunun parçası emniyet sistemi MGB-AR/MGB-AP) V3.0.0 ve üstü | 123151 | 01-02/15 |  |  0.3 MB |
| 安全信息 (安全系统 MGB-AR/MGB-AP使用说明书的组成部分) V3.0.0以上 | 123151 | 01-02/15 |  |  0.3 MB |
| 安全情報 MGB-AR/MGB-AP | 123151 | 01-02/15 |  |  0.6 MB |







Application example

Anschluss MGB-L1..-AR an Sicherheitsrelais ESM-BA..1

| | Doc. no. | Version | Language | Download |
|--|----------|----------|---|--|
| Anschluss MGB-L1..-AR an Sicherheitsrelais ESM-BA..1 | AP000143 | 06-03/16 |  |  0.3 MB |
| Connection of MGB-L1..-AR to Safety Relay ESM-BA..1 | AP000143 | 06-03/16 |  |  0.4 MB |

Declaration of conformity

EU-Konformitätserklärung

| | Doc. no. | Version | Language | Download |
|--|----------|----------|---|--|
| EU-Konformitätserklärung Declaración UE de conformidad Déclaration UE de conformité Dichiarazione di conformità EU declaration of conformity | 2123150 | 08-01/17 |      |  0.3 MB |