

## ITEM 157849 MGB-L1-ARA-AN3A1-S1-L-157849

Description	Technical data	Accessories	Downloads
-------------	----------------	-------------	-----------

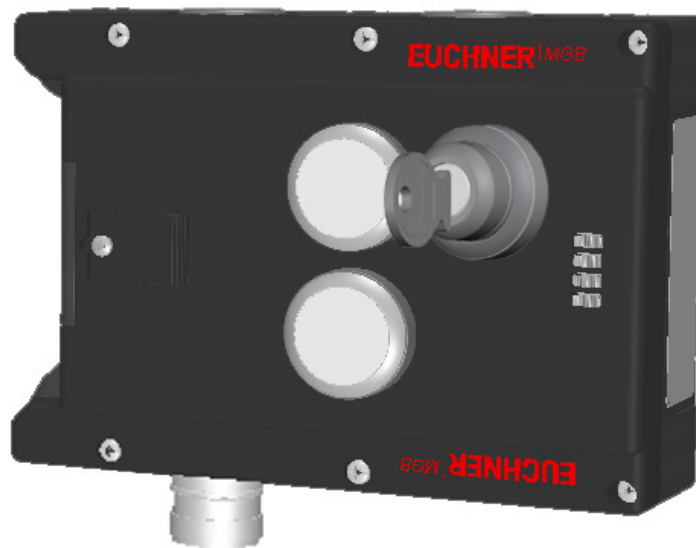

### Features

- › Guard locking with guard locking monitoring
- › Can be connected in series with other AR devices (e.g. CES-AR and CET-AR)
- › Key-operated rotary switch (form L, 90°)
- › Two pushbuttons (illuminated)
- › With lens set, six pcs.
- › With plug connector RC18
- › Unicode
- › IP 54

### Guard locking type

**MGB-** The locking arm is held in the locked position by spring force and is  
**L1...** unlocked by solenoid force (closed-circuit current principle, mechanically locked).

### Door stop

A mechanical door stop is permanently integrated into the evaluation module of the MGB. A marking on the stop makes adjustment easier.

## LED indicator

The LED indicator indicates all important system and status information.

---

## Monitoring outputs

- OD** ON when the door is closed
  - OT** Bolt tongue inserted in the evaluation module
  - OL** Guard locking solenoid in locked position
  - OI** Diagnostics; there is a fault
- 

## Key-operated rotary switch

- S1** Key-operated rotary switch with two positions (form L, 90°). The key latches in both positions and can be removed in both positions.
- 

## Pushbutton

- S2** One NO contact, illuminated
  - S3** One NO contact, illuminated
- 

## Lens set

The color of the pushbutton can be selected using the lens set included (five colors). Item no.: 120344 (see Accessories)

## Approvals



## Mechanical values and environment

Housing material	Reinforced plastic; die-cast zinc nickel-plated, stainless steel
Weight	Net 0,75 kg
Ambient temperature	-20 ... 55 °C
At $U_B = 24V$ DC	
Degree of protection	IP54
Mechanical life	$1 \times 10^6$
In case of use as door stop, and 1 Joule impact energy	$0,1 \times 10^6$
Installation position	Door hinge DIN left
Switching frequency	0,25 Hz
Connection	Plug connector RC 18 <sup>[1]</sup>
Guard locking principle	Closed-circuit current principle

Locking force $F_{Zh}$	2000 N
------------------------	--------

## Electrical connection ratings

Utilization category according to EN 60947-5-2	DC-13	24V 200mA [2]
Rated insulation voltage $U_i$		30 V
Rated impulse withstand voltage $U_{imp}$		1,5 kV
Degree of contamination (external, according to EN 60947-1)		3
Connection cross-section		
(Rigid/flexible)		0,13 ... 1,5 mm <sup>2</sup>
(Rigid/flexible) with cable end sleeve according to DIN 46 228/1		0,25 ... 1,5 mm <sup>2</sup>
(Rigid/flexible) with cable end sleeve with collar according to DIN 46 228/1		0,25 ... 0,75 mm <sup>2</sup>
Safety class		III
Discrepancy time		
Between FO1A and FO1B		max.10 ms
Risk time according to EN 60947-5-3		max.350 ms
Transponder coding		Unicode
		<b>Power supply <math>U_B</math></b>
Operating voltage DC	$U_B$	24 V DC -15% ... 10% [3]
Current consumption	$I_{UB}$	max.80 mA [4]
		<b>Power supply <math>U_A</math></b>
Operating voltage DC	$U_A$	24 V DC -15% ... 10% [5]
Current consumption	$I_{UA}$	max.375 mA [6]
		<b>Safety outputs FO1A, FO1B</b>
Test pulses		max.1 ms
Test-pulse interval		min.100 ms
Type of output		Semiconductor outputs, p-switching, short circuit-proof
Output voltage		
$U_{FO1A} / U_{FO1B}$ HIGH		$U_B - 2V \dots U_B$ V DC [7]
$U_{FO1A} / U_{FO1B}$ LOW		0 ... 1 V DC
Output current		
Per safety output FO1A / FO1B		1 ... 200 mA
		<b>Monitoring outputs OD, OT, OL, OI</b>
Type of output		Semiconductor outputs, p-switching, short circuit-proof
Output voltage		$U_A - 2V \dots U_A$ V DC [8]
Output current		max.50 mA
		<b>Controls and indicators</b>
Switching voltage		$U_A$ V

Switching current	1 ... 10 mA
Breaking capacity	max.0,25 W
Power supply LED	24 V DC
	<b>Solenoid control input IMP1, IMP2, IMM</b>
Test pulses	max.5 ms
Test-pulse interval	min.100 ms

## Controls and indicators

Assignment diagram	L1
Control/indicator	
	<b>Position 1</b>
Version	Key-operated switch
Special features	
Color	
Switching element	1NO
Control/indicator	
	<b>Position 2</b>
Version	Illuminated push buttons
Special features	
Color	
Switching element	1NO
Control/indicator	
	<b>Position 3</b>
Version	Illuminated push buttons
Special features	
Color	
Switching element	1NO

## Miscellaneous

Additional feature	Incl. cover set ID. No. 120344
Product version number	V3.0.3

## Reliability values acc. to EN ISO 13849-1

	<b>Monitoring of guard locking and the safety guard position</b>
Category	4
Performance Level	PL e
PFH <sub>D</sub>	$3.7 \times 10^{-9}$
	<b>Control of the guard locking</b>
Category	4
Performance Level	PL e
PFH <sub>D</sub>	$2.8 \times 10^{-9}$

[1] X6

[2] Caution: outputs must be protected with a free-wheeling diode in case of inductive loads.

[3, 5] (Reverse polarity protected, regulated, residual ripple <5%, PELV)

[4] (no load on outputs)

[6] (With energized guard locking solenoid and unloaded outputs OD, OT, OL, OI, +20 °C, 24V)

[7, 8] Value at a switching current of 50mA without taking into account the cable lengths

**Dimension drawing**

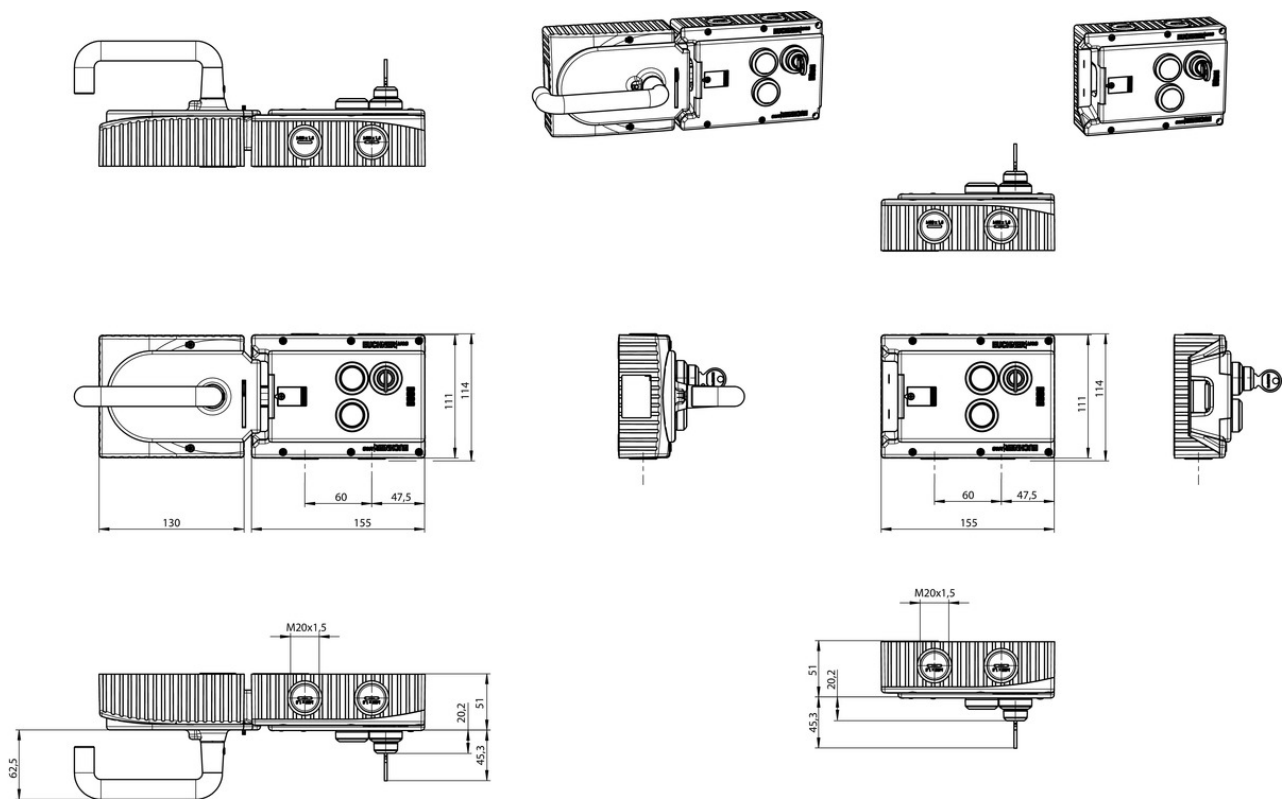

**Plug connector RC18**

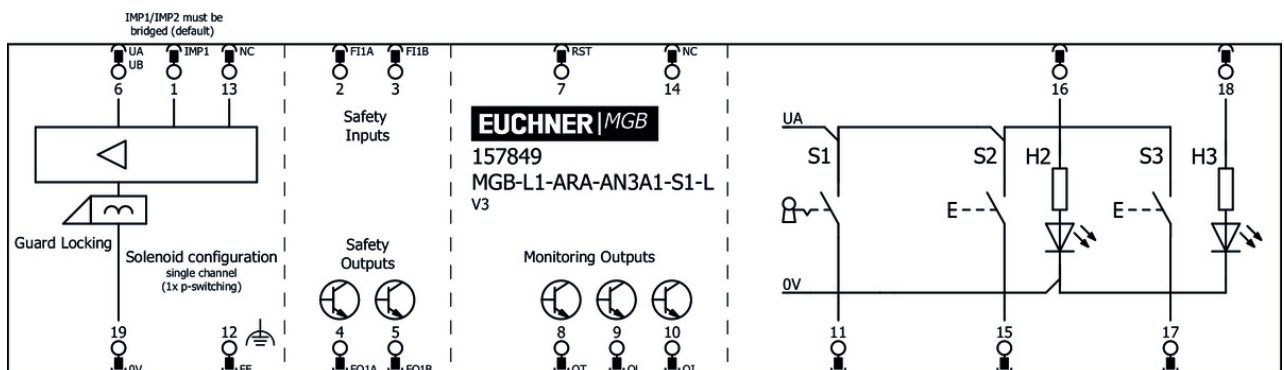

## Miscellaneous accessories

---

### ▼ Lens set 5 colors



**120344** AY-SET-LNS-0001-120344

### ▼ Lens set labeled



**120377** AY-SET-LNS-SY01-120377



**125359** AY-SET-LNS-SY02-125359



**126158** AY-SET-LNS-SY03-126158

### ▼ Lens set 6 colors



**120378** AY-SET-LNS-0002-120378

### ▼ Lens set, three colors



**158307** AY-SET-LNS-SY04-158307

## Mounting accessories

---

### ▼ Mounting plate for evaluation modules MGB-L.-AR.-... and MGB-L.-AP.-...



**109490** MGB-A-MOUNTINGPLATE-L-109490

#### ▼ Features

- › Easy and quick mounting (only two screws required)
- › Quick module replacement
- › Steel, powder-coated
- › Suitable for doors hinged on the right or left

## Function expansion

---

### ▼ Emergency unlocking for safety system MGB



**112989** MGB-A-EMERGENCYRELEASE-112989

#### ▼ Features

- › Quick emergency unlocking
  - › sealable
-

## Connection material

---

- ▼ Connection cable with plug connector M23 with option C1825, 3m, straight



**092816** C-M23F19-19XDIFPU03,0-MA-092816

- ▼ Features

- › M23 plug connector, 18-pin + PE
  - › Straight plug connector
  - › PUR cable
  - › Cable length 3 m
  - › With flying lead
  - › Cores color-coded
- 

- ▼ Connection cable with plug connector M23 with option C1825, 15m, straight



**077016** C-M23F19-19XDIFPU15,0-MA-077016

- ▼ Features

- › M23 plug connector, 18-pin + PE
  - › Straight plug connector
  - › PUR cable
  - › Cable length 15 m
  - › With flying lead
  - › Cores color-coded
- 

- ▼ Connection cable with plug connector M23 with option C1825, 40m, straight



**102490** C-M23F19-19XDIFPU40,0-MA-102490

- ▼ Features

- › M23 plug connector, 18-pin + PE
  - › Straight plug connector
  - › PUR cable
  - › Cable length 40 m
  - › With flying lead
  - › Cores color-coded
- 

- ▼ Replacement crimp contacts for female connector RC18 with option C1825

**094310** CRIMPKONTAKT BUCHSE RCF-C1825

- ▼ Features

- › 19 crimp sockets
  - › Conductor cross-section 16 x 0.25 - 0.5 mm<sup>2</sup> and 3 x 0.75 - 1 mm<sup>2</sup>
  - › For plug connector RC18..C1825
- 

- ▼ Connection cable with plug connector M23 with option C1825, 8m, straight



**077015** C-M23F19-19XDIFPU08,0-MA-077015

- ▼ Features

- › M23 plug connector, 18-pin + PE
- › Straight plug connector
- › PUR cable
- › Cable length 8 m
- › With flying lead

- › Cores color-coded
- 

- ▼ Connection cable with plug connector M23 with option C1825, 25m, straight



**092727** C-M23F19-19XDIFPU25,0-MA-092727

▼ Features

- › M23 plug connector, 18-pin + PE
  - › Straight plug connector
  - › PUR cable
  - › Cable length 25 m
  - › With flying lead
  - › Cores color-coded
- 

- ▼ Connection cable with plug connector M23 with option C1825, 1.5m, straight



**092761** C-M23F19-19XDIFPU01,5-MA-092761

▼ Features

- › M23 plug connector, 18-pin + PE
  - › Straight plug connector
  - › PUR cable
  - › Cable length 1.5 m
  - › With flying lead
  - › Cores color-coded
- 

- ▼ Connection cable with plug connector M23 with option C1825, 10m, straight



**092898** C-M23F19-19XDIFPU10,0-MA-092898

▼ Features

- › M23 plug connector, 18-pin + PE
  - › Straight plug connector
  - › PUR cable
  - › Cable length 10 m
  - › With flying lead
  - › Cores color-coded
- 

- ▼ Connection cable with plug connector M23 with option C1825, 30m, straight



**095993** C-M23F19-19XDIFPU30,0-MA-095993

▼ Features

- › M23 plug connector, 18-pin + PE
  - › Straight plug connector
  - › PUR cable
  - › Cable length 30 m
  - › With flying lead
  - › Cores color-coded
- 

- ▼ Female plug RC18 straight with option C1825



**077025** RC18EF-C1825

▼ Features

- › Plug connector M23, straight
- › Number of pins: 19-pin with screen bonding clamp



- ▼ Connection cable with plug connector M23 with option C1825, 6m, straight



**077014** C-M23F19-19XDIFPU06,0-MA-077014

▼ Features

- › M23 plug connector, 18-pin + PE
- › Straight plug connector
- › PUR cable
- › Cable length 6 m
- › With flying lead
- › Cores color-coded

- ▼ Connection cable with plug connector M23 with option C1825, 20m, straight



**092726** C-M23F19-19XDIFPU20,0-MA-092726

▼ Features

- › M23 plug connector, 18-pin + PE
- › Straight plug connector
- › PUR cable
- › Cable length 20 m
- › With flying lead
- › Cores color-coded

## Spare parts

- ▼ Replacement key for mechanical key release



**121809** MP-B-K-RK-00-00-121809

## Instructions



















- ▼ Návod k použití – bezpečnostní systémy MGB-L1...AR.-... / MGB-L2...AR.-... a MGB-L1...AP.-... / MGB-L2...AP.-... od V3.0.0

	Doc. no.	Version	Language	Download
Betriebsanleitung MGB-L1...AR.-... / MGB-L2...AR.-... und MGB-L1...AP.-... / MGB-L2...AP.-... ab V3.0.0	2119167	04-05/18		3.7 MB
Mode d'emploi MGB-L1...AR.-... / MGB-L2...AR.-... et MGB-L1...AP.-... / MGB-L2...AP.-... à partir de V3.0.0	2119167	04-05/18		3.7 MB
Manual de instrucciones MGB-L1...AR.-... / MGB-L2...AR.-... y MGB-L1...AP.-... / MGB-L2...AP.-... V3.0.0 o superior	2119167	04-05/18		3.7 MB
Návod k použití – bezpečnostní systémy MGB-L1...AR.-... / MGB-L2...AR.-... a MGB-L1...AP.-... / MGB-L2...AP.-... od V3.0.0	2119167	04-05/18		4.0 MB

Operating Instructions MGB-L1...AR-... / MGB-L2...AR-... and MGB-L1...AP-... / MGB-L2...AP-... from V3.0.0	2119167	04-05/18		3.7 MB
Istruzioni di impiego MGB-L1...AR-... / MGB-L2...AR-... und MGB-L1...AP-... / MGB-L2...AP-... da V3.0.0	2119167	04-05/18		3.7 MB
Handleiding MGB-L1...AR-... / MGB-L2...AR-... en MGB-L1...AP-... / MGB-L2...AP-... vanaf V3.0.0	2119167	04-05/18		3.7 MB
Instrukcja obsługi MGB-L1...AR-... / MGB-L2...AR-... i MGB-L1...AP-... / MGB-L2...AP-... od V3.0.0	2119167	04-05/18		4.0 MB
Manual de instruções MGB-L1...AR-... / MGB-L2...AR-... e MGB-L1...AP-... / MGB-L2...AP-... a partir de V3.0.0	2119167	04-05/18		3.7 MB
Инструкция по эксплуатации MGB-L1...AR-... / MGB-L2...AR-... и MGB-L1...AP-... / MGB-L2...AP-... с V3.0.0	2119167	04-05/18		4.2 MB
Návod na prevádzku Bezpečnostné systémy MGB-L1...AR-... / MGB-L2...AR-... a MGB-L1...AP-... / MGB-L2...AP-... od V3.0.0	2119167	04-05/18		4.0 MB
Instruktionsbok MGB-L1...AR-... / MGB-L2...AR-... och MGB-L1...AP-... / MGB-L2...AP-... fr. V3.0.0	2119167	04-05/18		3.7 MB
İşletim kılavuzu MGB-L1...AR-... / MGB-L2...AR-... ve MGB-L1...AP-... / MGB-L2...AP-... itibaren V3.0.0	2119167	04-05/18		4.1 MB
操作指示書 安全システム MGB-L1...AR-... / MGB-L2...AR-... および MGB-L1...AP-... / MGB-L2...AP-... V3.0.0以降	2119167	04-05/18		4.1 MB
使用说明书 安全系统 MGB-L1...AR-... / MGB-L2...AR-... 和 MGB-L1...AP-... / MGB-L2...AP-... V3.0.0 以上	2119167	04-05/18		4.1 MB







**Sicherheitsinformation (Teil der Betriebsanleitung Sicherheitssystem MGB-AR/MGB-AP) ab V3.0.0**

	Doc. no.	Version	Language	Download
Sicherheitsinformation (Teil der Betriebsanleitung Sicherheitssystem MGB-AR/MGB-AP) ab V3.0.0	123151	01-02/15		0.6 MB
Safety Information (Part of the Operating Instructions Safety System MGB-AR/MGB-AP) from V3.0.0				
Información de seguridad (parte del manual de instrucciones Sistema de seguridad MGB-AR/MGB-AP) V3.0.0 o superior				
Information de sécurité (partie du mode d'emploi Système de sécurité MGB-AR/MGB-AP) à partir de V3.0.0				
Informazioni sulla sicurezza (Parte delle istruzioni di impiego Sistema di sicurezza MGB-AR/MGB-AP) da V3.0.0				
Säkerhetsinformation (Del av instruktionsboken Säkerhetssystem MGB-AR/MGB-AP) från V3.0.0				

Veiligheidsinformatie (Deel van de handleiding Beveiligingssysteem MGB-AR/MGB-AP) vanaf V3.0.0	123151	01-02/15		 0.2 MB
Informação de segurança (Parte do manual de instruções Sistema de segurança MGB-AR/MGB-AP) a partir de V3.0.0	123151	01-02/15		 0.2 MB
Bezpečnostní informace (součást návodu k použití „Bezpečnostní systém MGB-AR/MGB-AP“) od V3.0.0	123151	01-02/15		 0.2 MB
Informacje o bezpieczeństwie (Część instrukcji obsługi System bezpieczeństwa MGB-AR/MGB-AP) od V3.0.0	123151	01-02/15		 0.2 MB
Информация о безопасности (часть инструкции по эксплуатации Предохранительная система MGB-AR/MGB-AP) с V3.0.0	123151	01-02/15		 0.3 MB
Bezpečnostná informácia (časť návodu na prevádzku Bezpečnostný systém MGB-AR/MGB-AP) od V3.0.0	123151	01-02/15		 0.2 MB
Güvenlik bilgisi (İşletim kılavuzunun parçası emniyet sistemi MGB-AR/MGB-AP) V3.0.0 ve üstü	123151	01-02/15		 0.3 MB
安全信息 (安全系统 MGB-AR/MGB-AP使用说明书的组成部分) V3.0.0以上	123151	01-02/15		 0.3 MB
安全情報 MGB-AR/MGB-AP	123151	01-02/15		 0.6 MB

## Declaration of conformity

### EU-Konformitätserklärung

	Doc. no.	Version	Language	Download
EU-Konformitätserklärung EU declaration of conformity Declaración UE de conformidad Déclaration UE de conformité Dichiarazione di conformità	2123150	08-01/17	    	 0.3 MB