

ITEM 114776 MGB-L2HECB-PNC-R-114776

Description	Technical data	Accessories	Downloads
-------------	----------------	-------------	-----------

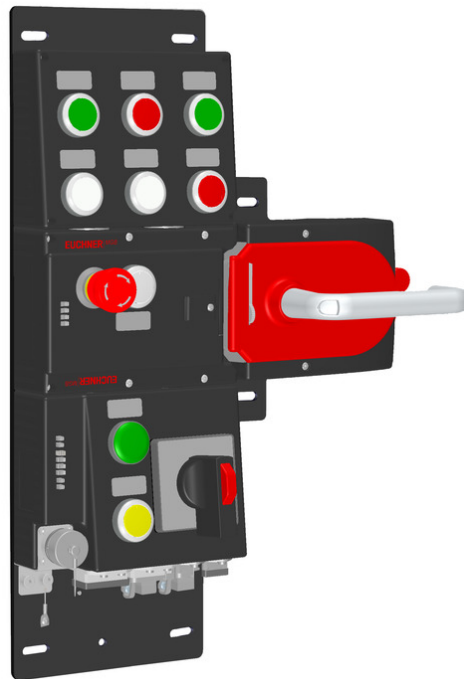

Features

- › Guard locking with guard lock monitoring
- › Emergency stop according to ISO 13850
- › 8 pushbuttons illuminated
- › Operating mode selector switch
- › 1 indicator
- › Push-pull plug
- › Including terminal plug for enabling switch (RC12, 12-pin)
- › Pre-assembled on mounting plates
- › Integrated Profinet RT switch
- › With escape release
- › Multicode

Profinet connection

Connection via push-pull plugs according to IEC 61076-3-117

Profinet RT switch

Point-to-point topology network structure due to integrated RT switch.

Flexible usage as interlocking or guard locking

By means of the corresponding evaluation of the safe device data by the control system, usage can be either as interlocking or guard locking (with or without monitoring).

Escape release

The escape release enables persons who are accidentally locked in to open the locked door from inside the danger area.

Components included in the set

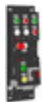

114778 Locking module MGB-L2CB-PNC-R-114778

▼ Features



111838 Handle module MGB-H-AA1A6-R-111838

▼ Features



106051 Escape release MGB-E-A2-106051

▼ Features

Dimension drawing

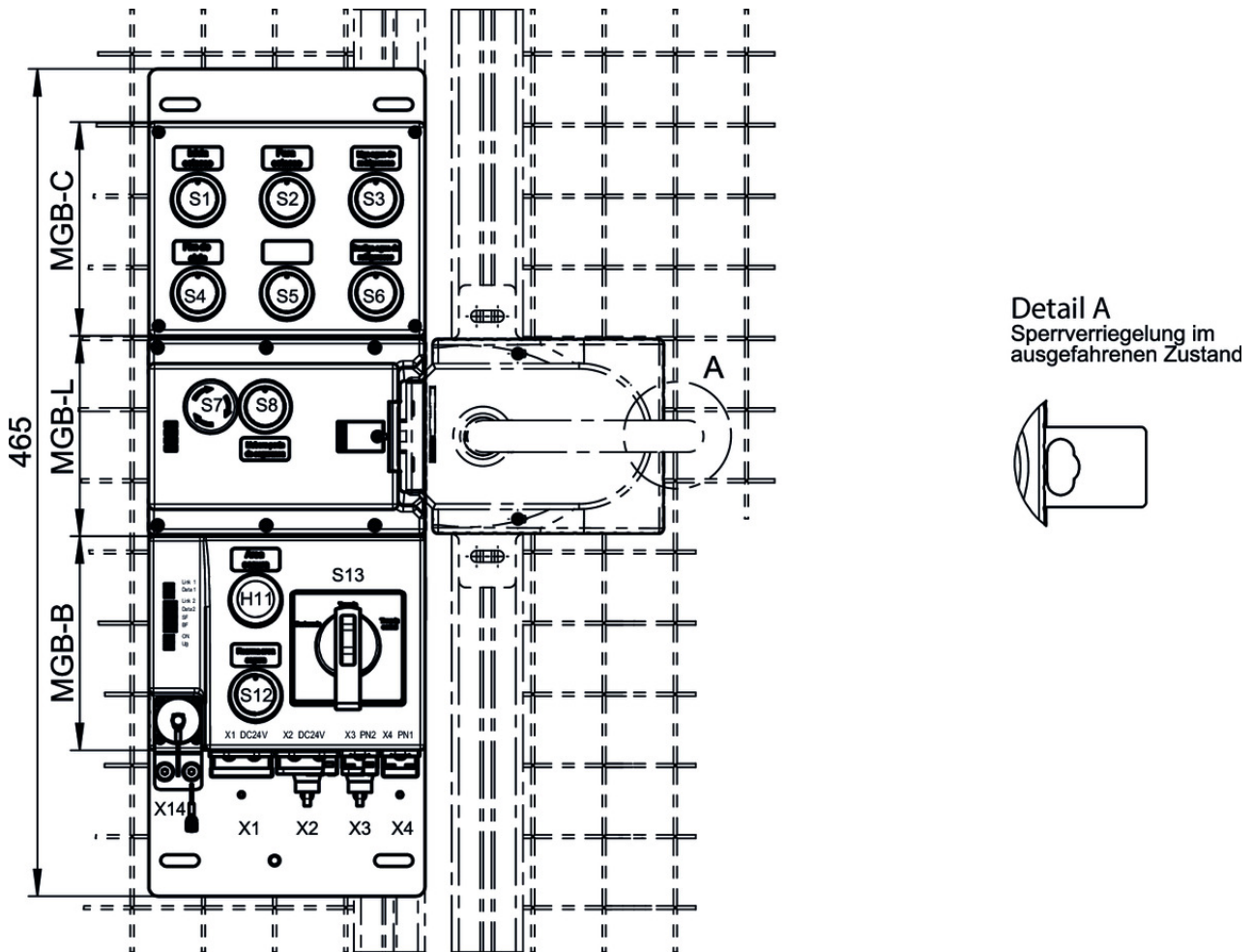

Spare parts

- ✓ Evaluation module with control and bus module MGB-...-PN with 11 controls and indicators, push-pull plug, RC12

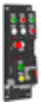

114778 MGB-L2CB-PNC-R-114778

✓ Features

- › Control panel
- › Emergency stop according to ISO 13850
- › 8 pushbuttons illuminated
- › Operating mode selector switch
- › 1 indicator
- › Including adhesive labels
- › Push-pull plug
- › Including terminal plug for enabling switch (RC12, 12-pin)
- › Pre-assembled on mounting plates
- › Integrated Profinet RT switch

- ✓ Handle module MGB-H... with automatically extending lockout mechanism



111838 MGB-H-AA1A6-R-111838

✓ Features

- › Intelligent bolt tongue

- › Fold-out lockout mechanism
 - › Second automatically extending lockout mechanism
 - › Door handle
 - › Mounting plate
-

▼ Handle module MGB-H...



111157 MGB-H-AA1A3-R-111157

▼ Features

- › Intelligent bolt tongue
 - › Fold-out lockout mechanism
 - › Second automatically extending lockout mechanism
 - › Door handle
-

Function expansion

▼ Escape release module MGB-E... pre-assembled on mounting plate



106051 MGB-E-A2-106051

▼ Features

- › Escape release out of the danger area
 - › Mounted on mounting plate
 - › With red handle
 - › 118 mm long
-

▼ Door knob for MGB-H...



111460 MGB-A-DOORKNOB-S1-111460

▼ Features

- › Aluminum, silver anodized
 - › For mounting on all MGB handle modules MGB-H... up to V2.0.0
 - › e.g. on sliding doors
-

▼ Emergency unlocking for safety system MGB



112989 MGB-A-EMERGENCYRELEASE-112989

▼ Features

- › Quick emergency unlocking
 - › sealable
-

▼ Door handle for MGB-E...



110276 MGB-A-DOORHANDLE-R1-110276

▼ Features

- › Aluminum, red painted
 - › For mounting on all MGB escape release modules MGB-E
-

▼ Door knob for MGB-E...



114904 MGB-A-DOORKNOB-R1-114904

▼ Features

- › Aluminum, red painted
- › For mounting on all MGB escape release modules MGB-E
- › e.g. on sliding doors

▼ Extended actuation axis for MGB-E...



106761 AY-ERS-250-106761

Miscellaneous accessories

▼ Lens set 5 colors



120344 AY-SET-LNS-0001-120344

▼ Lens set 6 colors



120378 AY-SET-LNS-0002-120378

▼ Lens set labeled



120377 AY-SET-LNS-SY01-120377



125359 AY-SET-LNS-SY02-125359



126158 AY-SET-LNS-SY03-126158

▼ Adhesive labels

114529 MGB-A-PLATESET-NN01-114529

▼ Features

- › Adhesive labels suitable for MGB evaluation modules, bus modules and control modules
- › silver, blank
- › Packaging unit = 10 pcs.

▼ Lens set, three colors



158307 AY-SET-LNS-SY04-158307

Enabling switch

- ▼ ZSB, housing G1, 3-stage, +/- pushbuttons, cable with plug connector RC12



077040 ZSB077040

▼ Features

- › Housing G1
 - › 3-stage function
 - › Straight connection cable, 5 m
 - › Plug connector
 - › 2 buttons
-

- ▼ ZSA, 3-stage with cable and plug connector RC12



092141 ZSA092141C2038

▼ Features

- › Housing G1
 - › 3-stage function
 - › Straight connection cable with plug connector, 5 m
 - › Direct connection to safety switch
-



097567 ZSA097567C2038

▼ Features

- › Housing G1
 - › 3-stage function
 - › Straight connection cable with plug connector, 10 m
 - › Direct connection to safety switch
-



099495 ZSA099495C2038

▼ Features

- › Housing G1
 - › 3-stage function
 - › Straight connection cable with plug connector, 15 m
 - › Direct connection to safety switch
-



100873 ZSA100873C2038

▼ Features

- › Housing G1
 - › 3-stage function
 - › Straight connection cable with plug connector, 25 m
 - › Direct connection to safety switch
-

- ▼ ZSM, + and - buttons, plug connector RC12



099716 ZSM2300-099716

▼ Features

- › 3-stage function
 - › + and - buttons
 - › Plug connector
 - › Straight connection cable, 5 m
-



113290 ZSM2300-113290

▼ Features

- › 3-stage function
- › + and - buttons
- › Plug connector
- › Straight connection cable, 13 m

▼ ZSB, housing G3, 3-stage, +/- pushbuttons, cable with plug connector RC12



077029 ZSB077029

▼ Features

- › 3-stage function
- › Housing G3
- › Straight connection cable, 5 m
- › Plug connector
- › Two illuminated buttons
- › Including holder

▼ ZSB, housing G3, 3-stage, +/- pushbuttons illuminated, cable with plug connector RC12



085058 ZSB085058

▼ Features

- › 3-stage function
- › Housing G3
- › Straight connection cable, 12 m
- › Plug connector
- › Two illuminated buttons
- › Including holder



Instructions

▼ Betriebsanleitung Sicherheitssysteme MGB-L..B-PN.-... (PROFINET) mit Datenstruktur Typ A ab V3.30.0

	Doc. no.	Version	Language	Download
Betriebsanleitung Sicherheitssysteme MGB-L..B-PN.-... (PROFINET) mit Datenstruktur Typ A ab V3.30.0	114575	04-03/15		2.7 MB
Operating Instructions Safety Systems MGB-L..B-PN.-... (PROFINET) with Data Structure Type A from V3.30.0	114575	04-03/15		2.8 MB





▼ Sicherheitsinformation (Teil der Betriebsanleitung Sicherheitssystem MGB-L.B-PN.-... (PROFINET)) ab V3.30.0

Doc. no.	Version	Language	Download
----------	---------	----------	----------





Sicherheitsinformation (Teil der Betriebsanleitung Sicherheitssystem MGB-L.B-PN.-... (PROFINET)) ab V3.30.0 Safety Information (Part of the Operating Instructions Safety System MGB-L.B-PN.-... (PROFINET)) from V3.30.0	123621	02-03/15		 0.2 MB
--	--------	----------	--	---

Application example

▼ Anschluss MGB-L1B-PN... an Siemens S7 315F (TIA Portal V13)







	Doc. no.	Version	Language	Download
Anschluss MGB-L1B-PN... an Siemens S7 315F (TIA Portal V13)	AP000226	01-02/17		 1.5 MB
Connecting MGB-L1B-PN... to Siemens S7 315F (TIA Portal V13)	AP000226	01-02/17		 1.7 MB

▼ Anschluss MGB-L2B-PN... an Siemens S7 315F

	Doc. no.	Version	Language	Download
Anschluss MGB-L2B-PN... an Siemens S7 315F	AP000222	02-09/16		 2.0 MB
Connection of MGB-L2B-PN... to Siemens S7 315F	AP000222	02-09/16		 1.6 MB

Declaration of conformity

▼ EU-Konformitätserklärung

	Doc. no.	Version	Language	Download
EU-Konformitätserklärung Declaración UE de conformidad Déclaration UE de conformité Dichiarazione di conformità EU declaration of conformity	2123624	06-01/17	    	 0.3 MB