

ITEM 116524 MGB-L2HB-PNC-L-116524

Description	Technical data	Accessories	Downloads
-------------	----------------	-------------	-----------

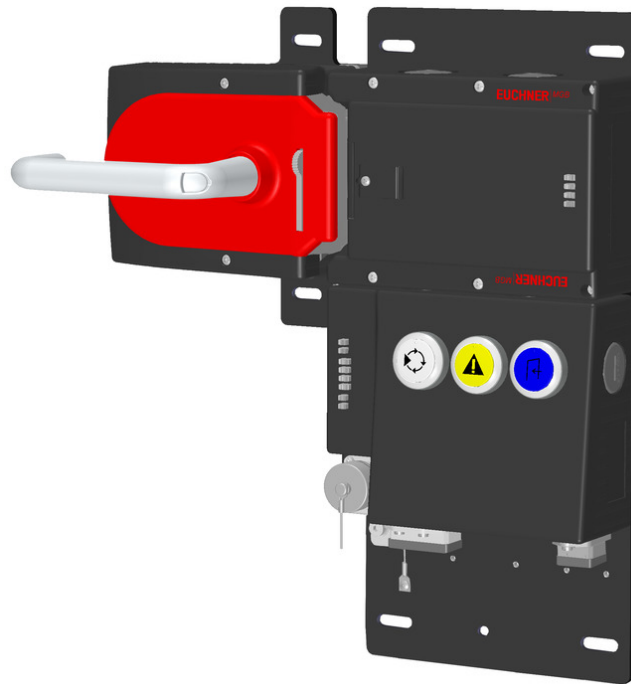

Features

- › Guard locking with guard lock monitoring
- › 3 illuminated pushbuttons
- › Push-pull plug
- › Including terminal plug for enabling switch (RC12, 12-pin)
- › Pre-assembled on mounting plates
- › Multicode

Profinet connection

Connection via push-pull plugs according to IEC 61076-3-117

Flexible usage as interlocking or guard locking

By means of the corresponding evaluation of the safe device data by the control system, usage can be either as interlocking or guard locking (with or without monitoring).

Components included in the set



116523 Locking module MGB-L2B-PNC-L-116523

✓ Features



111839 Handle module MGB-H-AA1A6-L-111839

✓ Features

Dimension drawing

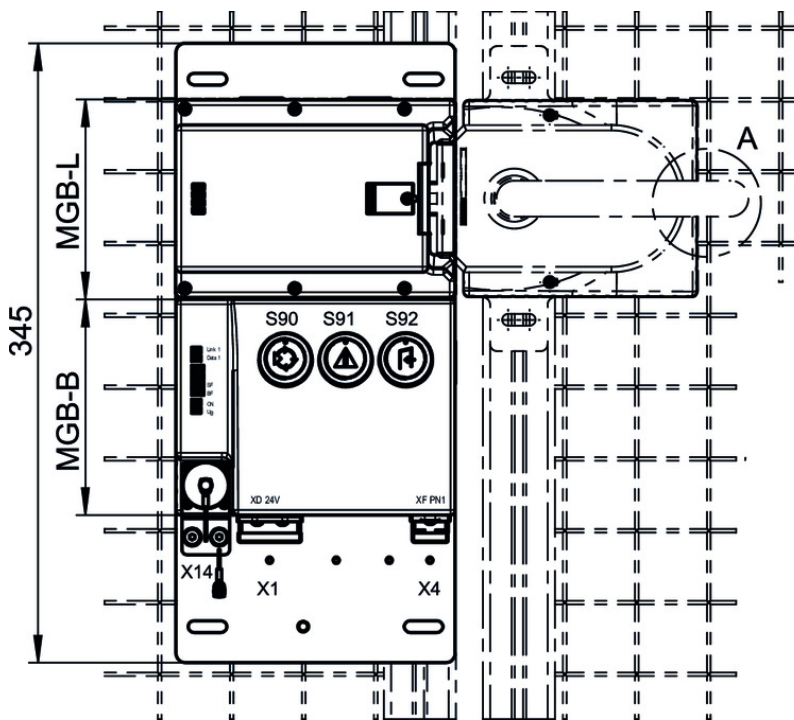

Detail A
Sperrverriegelung im
ausgefahrenen Zustand

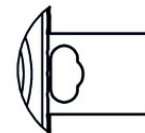

Spare parts

✓ Handle module MGB-H... with automatically extending lockout mechanism



111839 MGB-H-AA1A6-L-111839

✓ Features

- › Intelligent bolt tongue
- › Fold-out lockout mechanism
- › Second automatically extending lockout mechanism
- › Door handle
- › Mounting plate

✓ Evaluation module and bus module MGB-L2...-PN... (guard locking by solenoid force) with 3 controls, push-pull plug, RC12



116523 MGB-L2B-PNC-L-116523

✓ Features

- › Guard locking with guard lock monitoring

- › 3 illuminated pushbuttons
- › Push-pull plug
- › Including terminal plug for enabling switch (RC12, 12-pin)
- › Pre-assembled on mounting plates
- › Multicode

Miscellaneous accessories

▼ Lens set 5 colors



120344 AY-SET-LNS-0001-120344

▼ Lens set 6 colors



120378 AY-SET-LNS-0002-120378

▼ Lens set labeled



120377 AY-SET-LNS-SY01-120377



125359 AY-SET-LNS-SY02-125359



126158 AY-SET-LNS-SY03-126158

▼ Lens set, three colors



158307 AY-SET-LNS-SY04-158307

Function expansion

▼ Door handle for MGB-H...



110277 MGB-A-DOORHANDLE-S1-110277

▼ Features

- › Aluminum silver anodized
- › For mounting on all MGB handle modules MGB-H up to V2.0.0

▼ Escape release module MGB-E... pre-assembled on mounting plate



106051 MGB-E-A2-106051

▼ Features

- › Escape release out of the danger area

- › Mounted on mounting plate
- › With red handle
- › 118 mm long

▼ Door knob for MGB-H...



111460 MGB-A-DOORKNOB-S1-111460

▼ Features

- › Aluminum, silver anodized
- › For mounting on all MGB handle modules MGB-H... up to V2.0.0
- › e.g. on sliding doors

▼ Emergency unlocking for safety system MGB



112989 MGB-A-EMERGENCYRELEASE-112989

▼ Features

- › Quick emergency unlocking
- › sealable

Instructions

▼ Betriebsanleitung Sicherheitssysteme MGB-L..B-PN.-... (PROFINET) mit Datenstruktur Typ B ab V3.30.0

	Doc. no.	Version	Language	Download
Betriebsanleitung Sicherheitssysteme MGB-L..B-PN.-... (PROFINET) mit Datenstruktur Typ B ab V3.30.0	115174	07-02/15		3.2 MB
Operating Instructions Safety Systems MGB-L..B-PN.-... (PROFINET) with Data Structure Type B from V3.30.0	115174	07-02/15		3.2 MB



▼ Sicherheitsinformation (Teil der Betriebsanleitung Sicherheitssystem MGB-L.B-PN.-... (PROFINET)) ab V3.30.0

	Doc. no.	Version	Language	Download
Sicherheitsinformation (Teil der Betriebsanleitung Sicherheitssystem MGB-L.B-PN.-... (PROFINET)) ab V3.30.0 Safety Information (Part of the Operating Instructions Safety System MGB-L.B-PN.-... (PROFINET)) from V3.30.0	123621	02-03/15	 	0.2 MB





Application example

▼ Anschluss MGB-L1B-PN... an Siemens S7 315F (TIA Portal V13)

	Doc. no.	Version	Language	Download
Anschluss MGB-L1B-PN... an Siemens S7 315F (TIA Portal V13)	AP000226	01-02/17		1.5 MB





Connecting MGB-L1B-PN... to Siemens S7 315F (TIA Portal V13) AP000226 01-02/17   1.7 MB

 Anschluss MGB-L2B-PN... an Siemens S7 315F

	Doc. no.	Version	Language	Download
Anschluss MGB-L2B-PN... an Siemens S7 315F	AP000222	02-09/16		 2.0 MB
Connection of MGB-L2B-PN... to Siemens S7 315F	AP000222	02-09/16		 1.6 MB

Declaration of conformity

 EU-Konformitätserklärung

	Doc. no.	Version	Language	Download
EU-Konformitätserklärung	2123624	06-01/17		 0.3 MB
Declaración UE de conformidad				
Déclaration UE de conformité				
Dichiarazione di conformità				
EU declaration of conformity			