

ITEM 126636 MGB-L1HB-EIA-R-126636

Description	Technical data	Accessories	Downloads
-------------	----------------	-------------	-----------

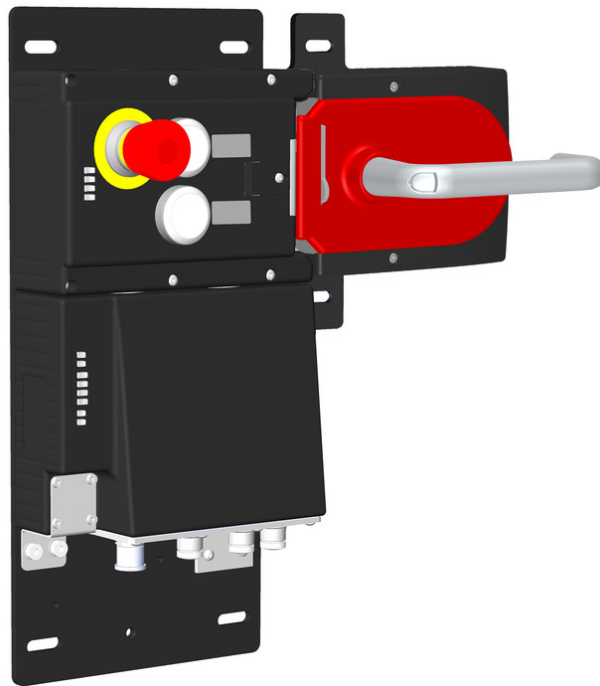

Features

- › Guard locking with guard lock monitoring
- › Emergency stop according to ISO 13850, illuminated
- › 2 illuminated pushbuttons
- › Including adhesive labels
- › Connection via M12 plug
- › Pre-assembled on mounting plates
- › Unicode

Components included in the set



126635 Locking module MGB-L1B-EIA-R-126635
✓ Features



111838 Handle module MGB-H-AA1A6-R-111838
✓ Features

Dimension drawing

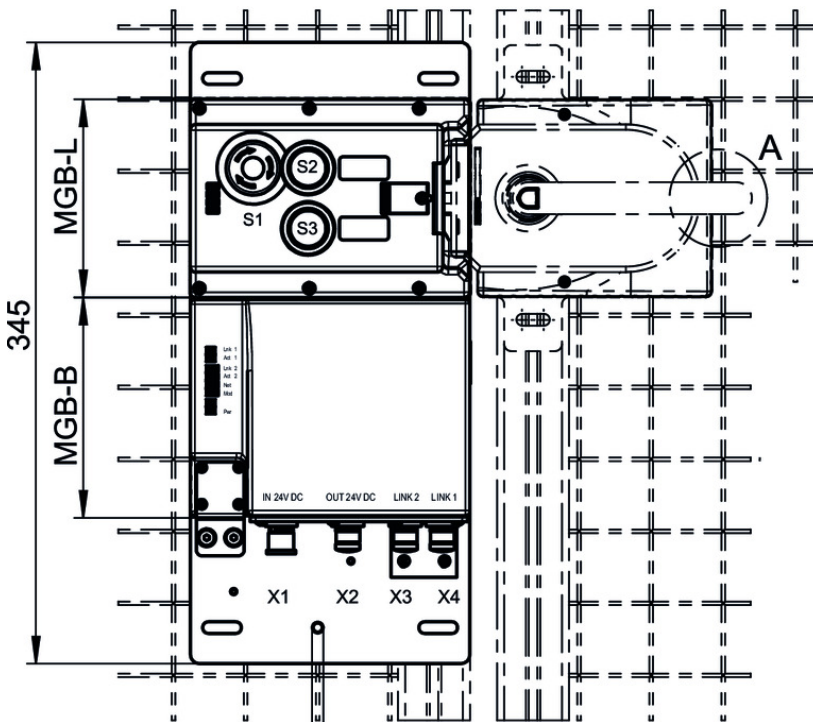

inklusive M6
Funktionserde
including
function earth

Detail A

Sperrverriegelung im
ausgefahrenen Zustand
Automatic lockoutbar in "open" position.

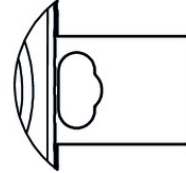

Wiring diagram

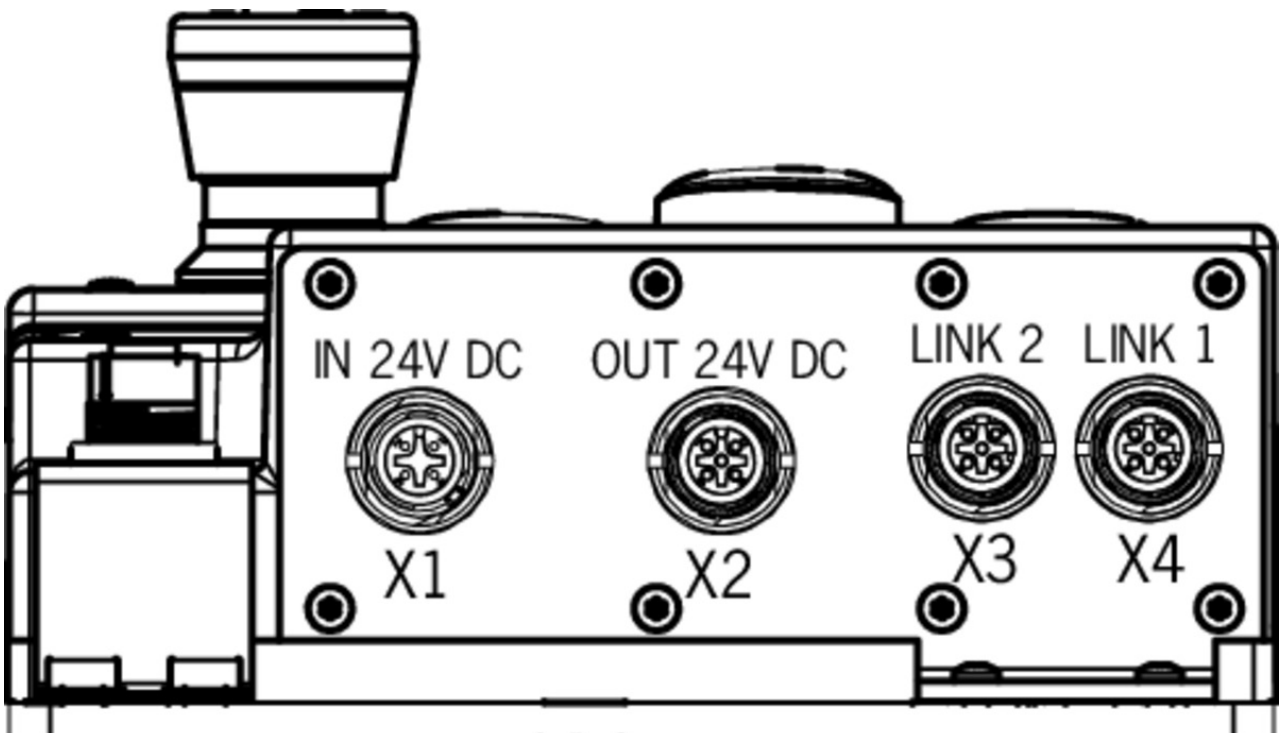

Spare parts

- ▼ Handle module MGB-H... with automatically extending lockout mechanism



111838 MGB-H-AA1A6-R-111838

- ▼ Features

- › Intelligent bolt tongue
 - › Fold-out lockout mechanism
 - › Second automatically extending lockout mechanism
 - › Door handle
 - › Mounting plate
-

- ▼ Locking module MGB-L1...-EI (guard locking by spring force) with 2 push buttons, emergency stop



126635 MGB-L1B-EIA-R-126635

- ▼ Features

- › Guard locking with guard lock monitoring
 - › Emergency stop according to ISO 13850, illuminated
 - › 2 illuminated pushbuttons
 - › Including adhesive labels
 - › Connection via M12 plug
 - › Pre-assembled on mounting plates
 - › Unicode
-

Function expansion

- ▼ Escape release module MGB-E... pre-assembled on mounting plate



106051 MGB-E-A2-106051

- ▼ Features

- › Escape release out of the danger area
 - › Mounted on mounting plate
 - › With red handle
 - › 118 mm long
-

- ▼ Door handle for MGB-H...



123926 MGB-A-DOORHANDLE-S2-123926

- ▼ Features

- › Aluminum silver anodized
 - › For mounting on all MGB handle modules MGB-H from V3.0.0
-

- ▼ Door knob for MGB-H...



124030 MGB-A-DOORKNOB-S2-124030

- ▼ Features

- › Aluminum, silver anodized
 - › For mounting on all MGB handle modules MGB-H... from V3.0.0
 - › e.g. on sliding doors
-

▼ Emergency unlocking for safety system MGB



112989 MGB-A-EMERGENCYRELEASE-112989

▼ Features

- › Quick emergency unlocking
 - › sealable
-

Miscellaneous accessories

▼ Lens set 5 colors



120344 AY-SET-LNS-0001-120344

▼ Lens set 6 colors



120378 AY-SET-LNS-0002-120378

▼ Lens set labeled



120377 AY-SET-LNS-SY01-120377



125359 AY-SET-LNS-SY02-125359



126158 AY-SET-LNS-SY03-126158

▼ Adhesive labels

114529 MGB-A-PLATESET-NN01-114529

▼ Features

- › Adhesive labels suitable for MGB evaluation modules, bus modules and control modules
 - › silver, blank
 - › Packaging unit = 10 pcs.
-

▼ Lens set, three colors



158307 AY-SET-LNS-SY04-158307

Instructions

▼ Betriebsanleitung Sicherheitssysteme MGB-L..B-EI-... (Ethernet/IP) mit Datenstruktur Typ A

	Doc. no.	Version	Language	Download
Betriebsanleitung Sicherheitssysteme MGB-L..B-EI-... (Ethernet/IP) mit Datenstruktur Typ A	2126330	07-08/17		2.8 MB
Manual de instrucciones Sistemas de seguridad MGB-L..B-EI-... (Ethernet/IP) y con estructura de datos de tipo A	2126330	07-08/17		2.8 MB
Instrucțiuni de utilizare Sisteme de siguranță MGB-L..B-EI-... (Ethernet/IP) și cu structură de date tip A	2126330	07-08/17		3.0 MB
Operating Instructions Safety Systems MGB-L..B-EI-... (Ethernet/IP) With Data Structure Type A	2126330	07-08/17		2.8 MB

▼ Informații privind siguranța și întreținerea MGB-L.B-EI-... (Ethernet/IP)

	Doc. no.	Version	Language	Download
Sicherheitsinformation und Wartung Sicherheitssystem MGB-L.B-EI-... (Ethernet/IP) Safety Information and Maintenance Safety System MGB-L.B-EI-... (Ethernet/IP) Información de seguridad y mantenimiento Sistema de seguridad MGB-L.B-EI-... (Ethernet/IP)	126331	01-01/16	 	0.3 MB
Informații privind siguranța și întreținerea MGB-L.B-EI-... (Ethernet/IP)	126331	01-01/16		0.2 MB

Catalogs

▼ Conexión fácil: MGB con EtherNet/IP

	Doc. no.	Version	Language	Download
Conexión fácil: MGB con EtherNet/IP Simple à raccorder - MGB avec EtherNet/IP	126944	04-03/16	 	0.3 MB

▼ Multifunctional Gate Box MGB - EtherNet/IP

	Doc. no.	Version	Language	Download
Multifunctional Gate Box MGB - EtherNet/IP Multifunctional Gate Box MGB - EtherNet/IP	155935	02-06/17	 	0.9 MB



Application example

▼ AOI für MGB-L1B-EI... an Allen Bradley ControlLogix





	Doc. no.	Version	Language	Download
AOI für MGB-L1B-EI... an Allen Bradley ControlLogix	AP000224	01-07/16		0.8 MB
AOI for MGB-L1B-EI... on Allen Bradley ControlLogix	AP000224	01-07/16		0.9 MB

▼ Anschluss MGB-L1B-EI... an Allen Bradley ControlLogix

	Doc. no.	Version	Language	Download
Anschluss MGB-L1B-EI... an Allen Bradley ControlLogix	AP000223	03-08/16		0.7 MB







Connection of MGB-L1B-EI... to Allen Bradley ControlLogix	AP000223	03-08/16		 0.7 MB
---	----------	----------	--	---

▼ MGB-L1B-EI... an Allen Bradley ControlLogix mit Gateway im Netz

	Doc. no.	Version	Language	Download
MGB-L1B-EI... an Allen Bradley ControlLogix mit Gateway im Netz	AP000228	01-05/17		 0.6 MB
MGB-L1B-EI... on Allen Bradley ControlLogix with Gateway in Network	AP000228	01-05/17		 0.6 MB

Declaration of conformity

▼ EU-Konformitätserklärung

	Doc. no.	Version	Language	Download
EU-Konformitätserklärung Declaración UE de conformidad Déclaration UE de conformité Dichiarazione di conformità EU declaration of conformity	2123624	06-01/17	    	 0.3 MB