

ITEM 082205 EGM12SEM4

Description	Technical data	Accessories	Downloads
-------------	----------------	-------------	-----------



Features

- › With snap-action switching element
- › Plunger material stainless steel
- › Any installation position

Switching element

Snap-action switching contact, 1 changeover contact

⚠ Single hole fixing limit switches must not be used as an end stop.

Approvals



Mechanical values and environment

Design	Thread M12 x 1
--------	----------------

Housing material	Stainless steel
Ambient temperature	-20 ... 80 °C
Degree of protection	IP65 [1]
Mechanical life	1 x 10 ⁶
Contact material	Silver alloy, gold-plated
Switching principle	Snap-action switching contact
Repeat accuracy (absolute)	±0,01 mm [2]
Installation position	Any
Number of NC contacts	1 [3]
Number of NO contacts	1 [4]
Connection	Plug connector M12 [5]
Approach speed	0,01 ... 8 m/min
Actuating element	Flat plunger [6]
Actuating force	Approx. 16 N

Electrical connection ratings

Utilization category according to EN 60947-5-1	
AC-15	0.5A 50V
DC-13	0.6A 24V
Short circuit protection according to IEC 60269-1	2A gG
Rated insulation voltage U _i	50 V
Rated impulse withstand voltage U _{imp}	1,5 kV
Switching voltage	
min.	12 V
Switching current	
Min. at 24V	10 mA

[1] Mating connector inserted and screwed tight.

[2] On axial actuation in the retracted state after approx. 2000 operating cycles

[3, 4] Changeover contact

[5] 4-pin

[6] Short

Dimension drawing

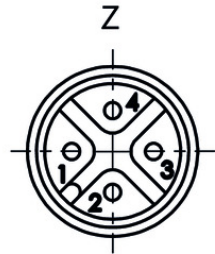
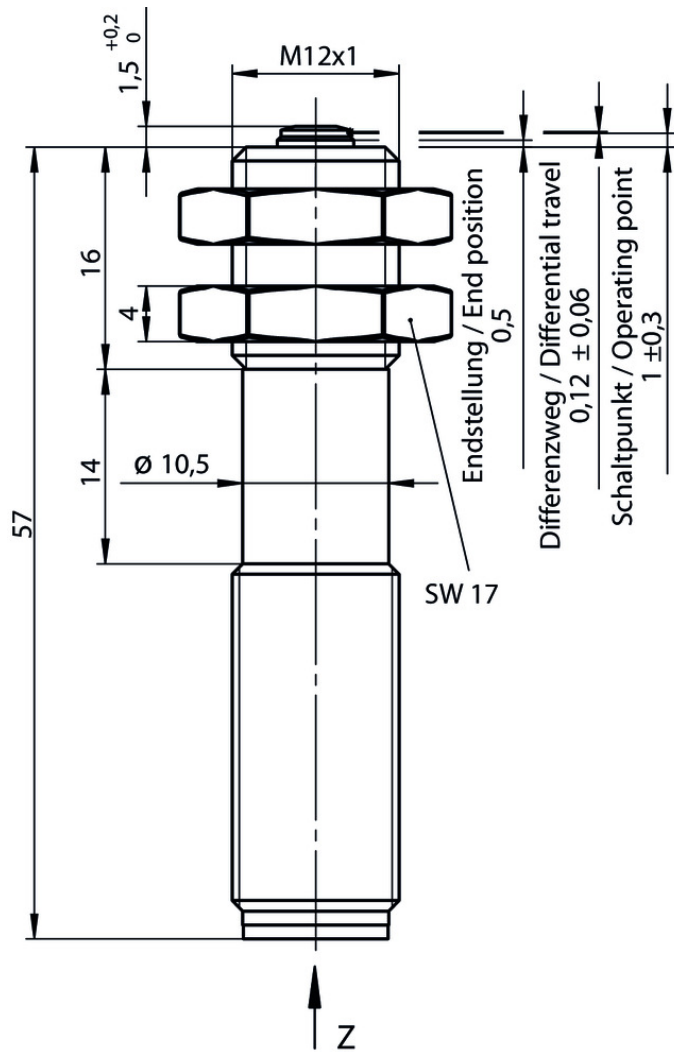

Wiring diagram

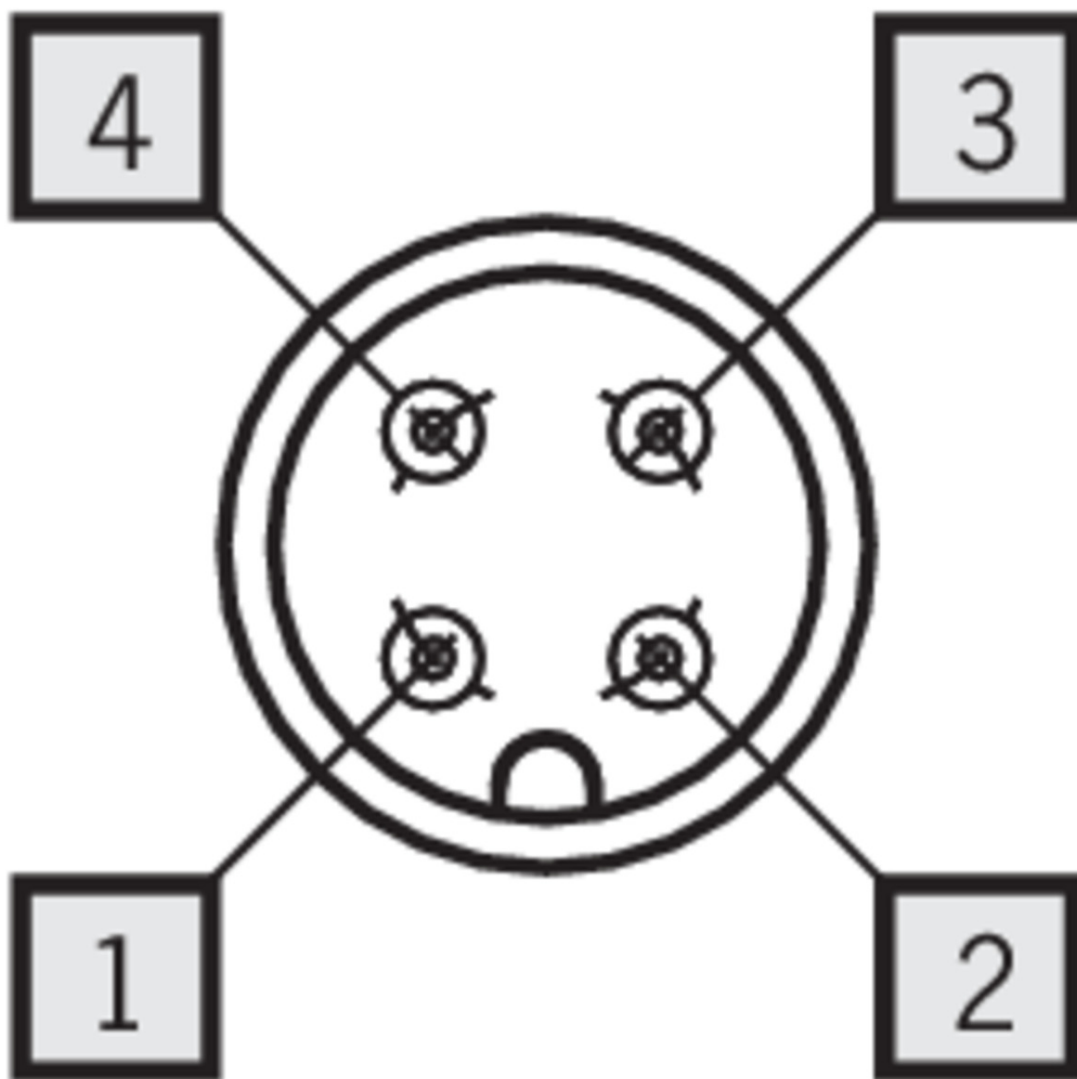

Wiring diagram

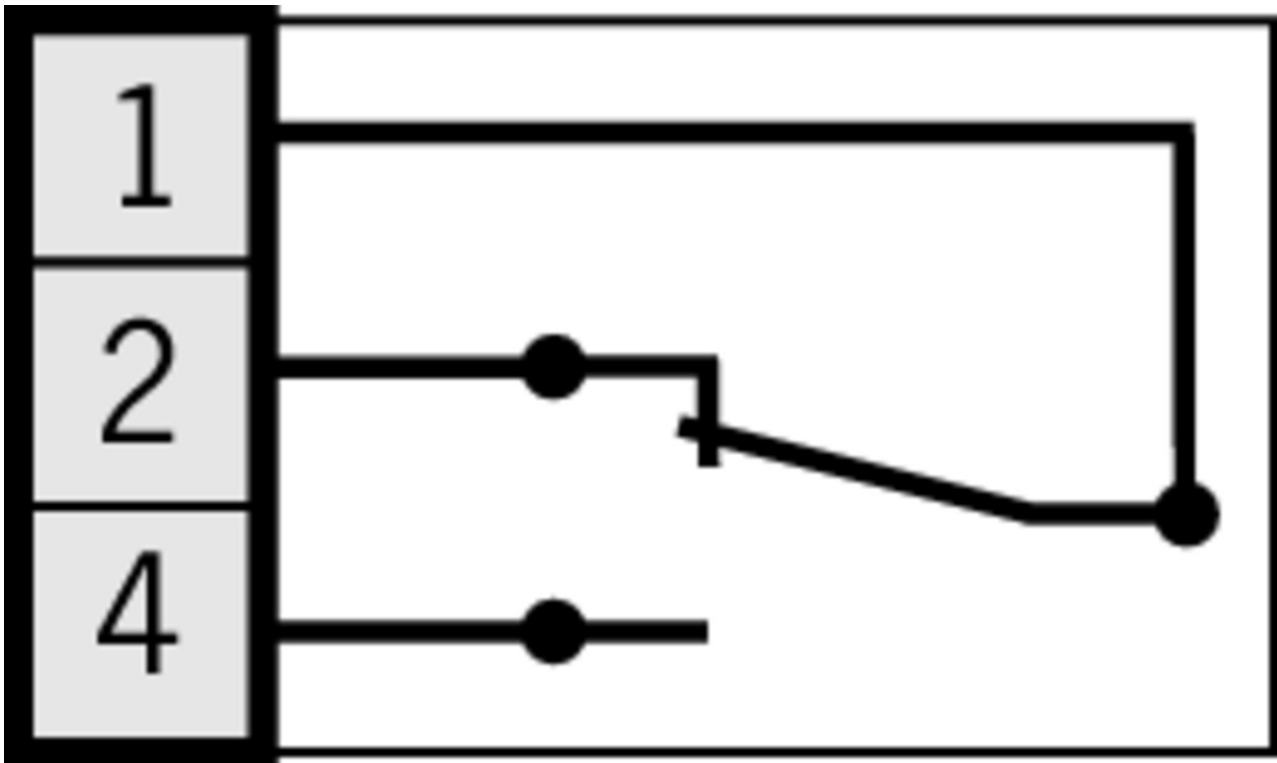

Connection material

Plug connector M12



035613 C-M12F04-04X034PU05,0-GA-035613

Features

- › M12 female plug, 4-pin
- › Straight plug connector
- › PUR cable
- › Halogen-free
- › Cable length 5 m
- › With flying lead
- › Cores color-coded



035618 C-M12F04-04X034PU05,0-GA-035618

Features

- › M12 female plug, 4-pin
- › Angled plug connector
- › PUR cable
- › Halogen-free
- › Cable length 5 m
- › With flying lead
- › Cores color-coded



041091 C-M12F04-04X034PU05,0-GA-041091







Features

- › M12 female plug, 4-pin
- › Angled plug connector
- › PUR cable

- › Halogen-free
- › Cable length 5 m
- › With flying lead
- › Cores color-coded

Catalogs

- ▼ Positionsschalter und Reihengrenztaster Position Switches and Multiple Limit Switches
Interrupteurs de position et boîtiers multipistes

	Doc. no.	Version	Language	Download
Positionsschalter und Reihengrenztaster	157835	01-03/18		 4.1 MB
Interrupteurs de position et boîtiers multipistes	157837	01-03/18		 4.1 MB
Position Switches and Multiple Limit Switches	157836	01-03/18		 4.1 MB

CAD data

CAD data for this item on TraceParts