

## ITEM 093733 EGM12SEM4C1820

Description	Technical data	Accessories	Downloads
-------------	----------------	-------------	-----------



### Features

- › With snap-action switching element
- › Plunger material stainless steel
- › Any installation position

### Switching element

Snap-action switching contact, 1 changeover contact

⚠ Single hole fixing limit switches must not be used as an end stop.

### Approvals



### Mechanical values and environment

Design	Thread M12 x 1
--------	----------------

Housing material	Stainless steel
Ambient temperature	-30 ... 85 °C
Degree of protection	IP65 <b>[1]</b>
Mechanical life	1 x 10 <sup>6</sup>
Contact material	Silver alloy, gold-plated
Switching principle	Snap-action switching contact
Repeat accuracy (absolute)	±0,01 mm <b>[2]</b>
Installation position	Any
Number of NC contacts	1 <b>[3]</b>
Number of NO contacts	1 <b>[4]</b>
Connection	Plug connector M12 <b>[5]</b>
Approach speed	0,01 ... 8 m/min
Actuating element	Flat plunger <b>[6]</b>
Actuating force	Approx. 16 N

### Electrical connection ratings

Utilization category according to EN 60947-5-1	
AC-15	0.5A 50V
DC-13	0.6A 24V
Short circuit protection according to IEC 60269-1	2A gG
Rated insulation voltage U <sub>i</sub>	50 V
Rated impulse withstand voltage U <sub>imp</sub>	1,5 kV
Switching voltage	
min.	12 V
Switching current	
Min. at 24V	10 mA

### Miscellaneous

C number	
C1820	Diaphragm made of silicone

**[1]** Mating connector inserted and screwed tight.

**[2]** On axial actuation in the retracted state after approx. 2000 operating cycles

**[3, 4]** Changeover contact

**[5]** 4-pin

**[6]** Short

# Dimension drawing

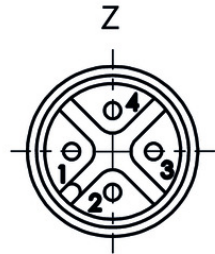
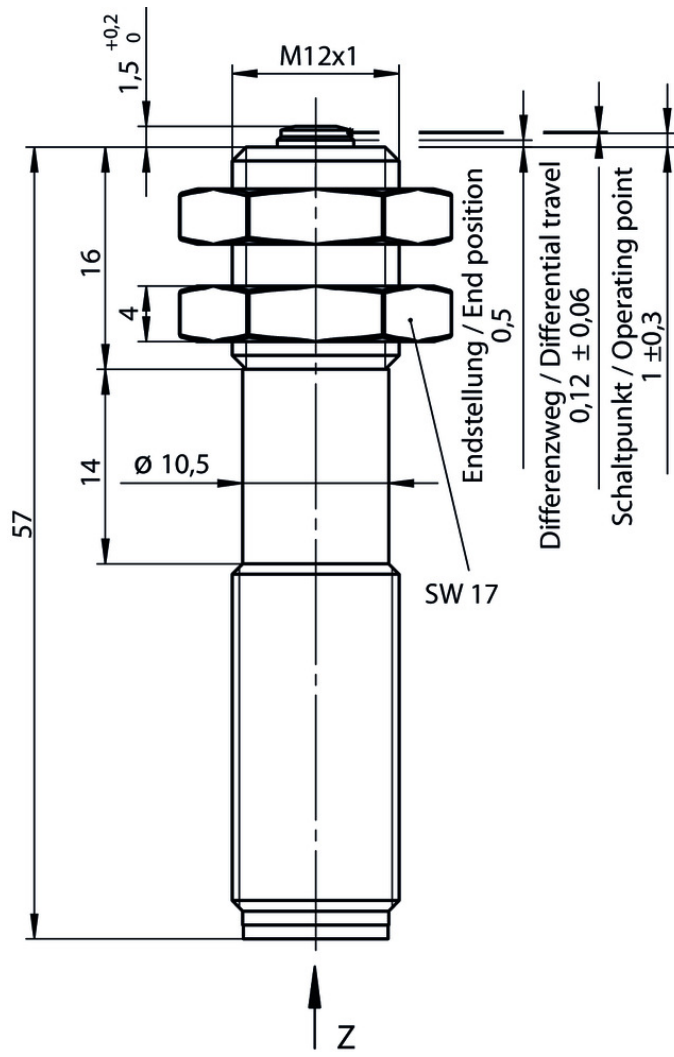

Wiring diagram

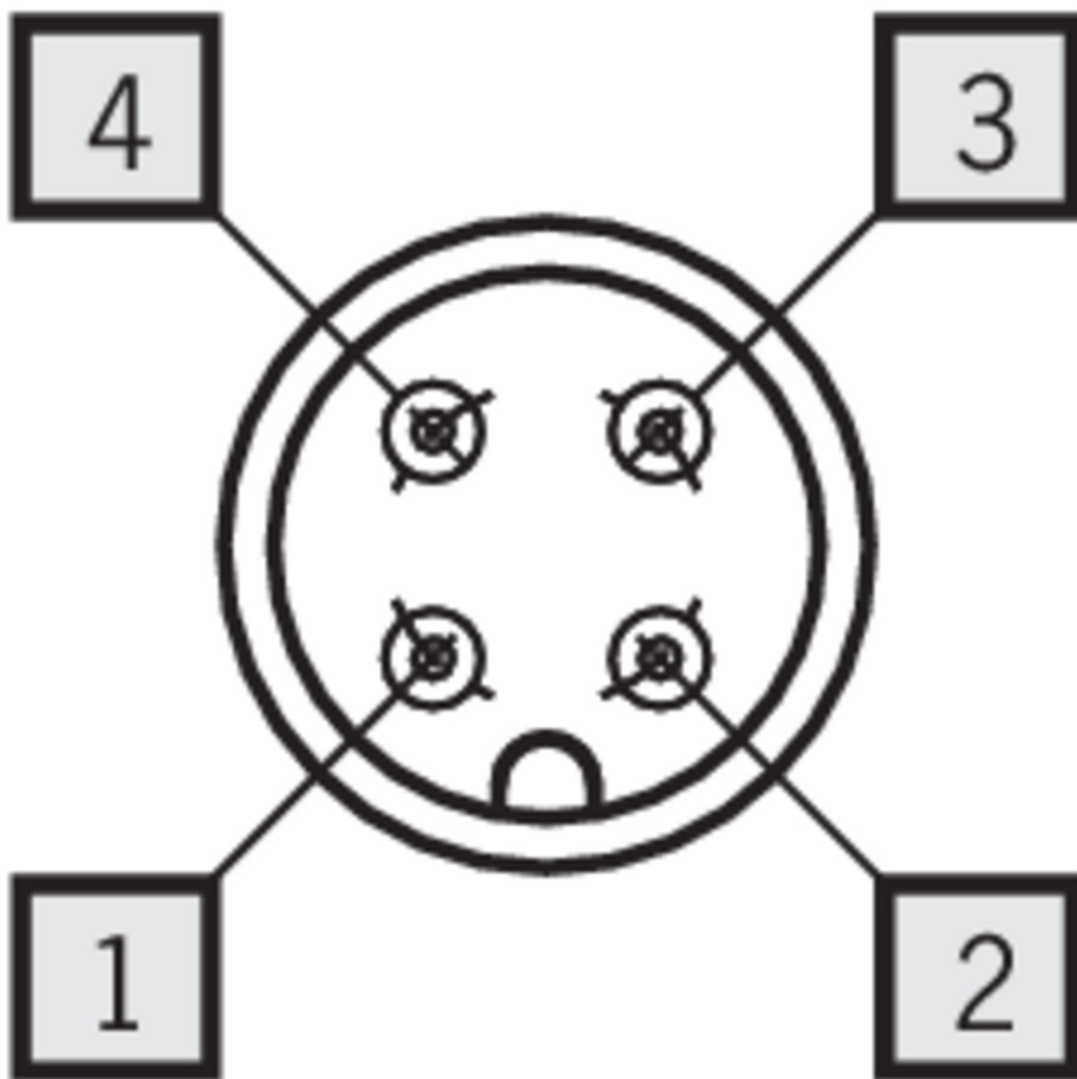

## Wiring diagram

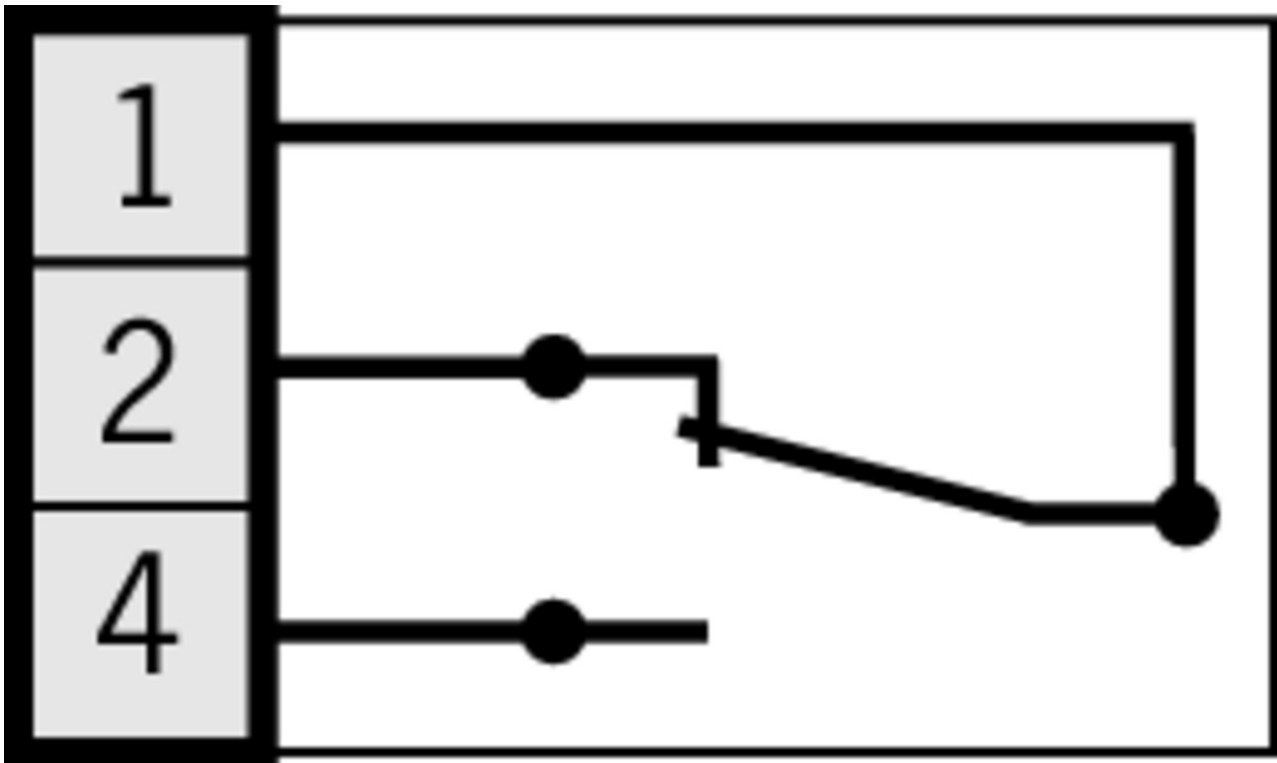

## Connection material

### Plug connector M12



**035613** C-M12F04-04X034PU05,0-GA-035613

#### Features

- › M12 female plug, 4-pin
- › Straight plug connector
- › PUR cable
- › Halogen-free
- › Cable length 5 m
- › With flying lead
- › Cores color-coded



**035618** C-M12F04-04X034PU05,0-GA-035618

#### Features

- › M12 female plug, 4-pin
- › Angled plug connector
- › PUR cable
- › Halogen-free
- › Cable length 5 m
- › With flying lead
- › Cores color-coded



**041091** C-M12F04-04X034PU05,0-GA-041091







#### Features

- › M12 female plug, 4-pin
- › Angled plug connector
- › PUR cable

- › Halogen-free
  - › Cable length 5 m
  - › With flying lead
  - › Cores color-coded
- 

## Catalogs

- ▼ Positionsschalter und Reihengrenztaster Position Switches and Multiple Limit Switches  
Interrupteurs de position et boîtiers multipistes

	Doc. no.	Version	Language	Download
Positionsschalter und Reihengrenztaster	157835	01-03/18		 4.1 MB
Interrupteurs de position et boîtiers multipistes	157837	01-03/18		 4.1 MB
Position Switches and Multiple Limit Switches	157836	01-03/18		 4.1 MB

## CAD data

CAD data for this item on TraceParts