

## ITEM 094823 EGZ12-12-5000

Description	Technical data	Accessories	Downloads
-------------	----------------	-------------	-----------



### Features

- › Switching element, with three switching contacts
- › With slow-action switching element
- › Plunger and housing made of high-quality stainless steel
- › Any installation position
- › Threaded section M12x1

### Switching element

Slow-action switching contact

⚠ Single hole fixing limit switches must not be used as an end stop.

### Approvals



### Mechanical values and environment

Design	Thread M12 x 1
Housing material	Stainless steel
Ambient temperature	-20 ... 80 °C
Degree of protection	IP67
Mechanical life	$3 \times 10^6$
Contact material	Silver alloy, gold flashed
Switching principle	Slow-action switching contact
Repeat accuracy (absolute)	$\pm 0,01$ mm <b>[1]</b>
Installation position	Any
Number of positively driven contacts	2
Number of NO contacts	1
Connection	PUR cable <b>[2]</b>
Cable length	5 m
Approach speed	max.8 m/min
Actuating element	Domed plunger
Actuating force	max.16 N

### Electrical connection ratings

Utilization category according to EN 60947-5-1	
	AC-15 4A 230V
	DC-13 4A 24V
Short circuit protection according to IEC 60269-1	4A gG
Rated insulation voltage $U_i$	250 V
Rated impulse withstand voltage $U_{imp}$	2,5 kV
Switching voltage	
	min. 12 V
Switching current	
	Min. at 24V 1 mA
Connection cross-section	0,5 mm <sup>2</sup>

**[1]** On axial actuation in the retracted state after approx. 2000 operating cycles

**[2]** Seven-core

# Dimension drawing

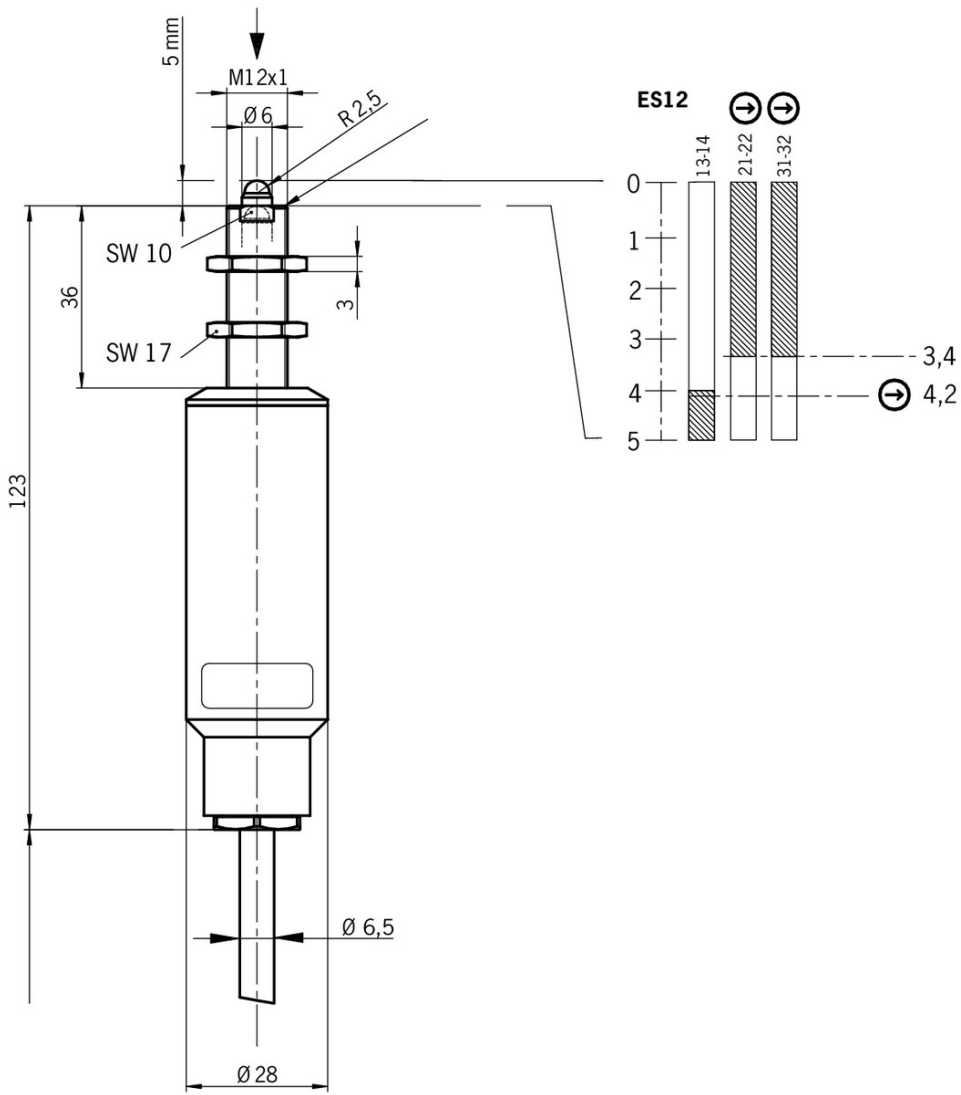

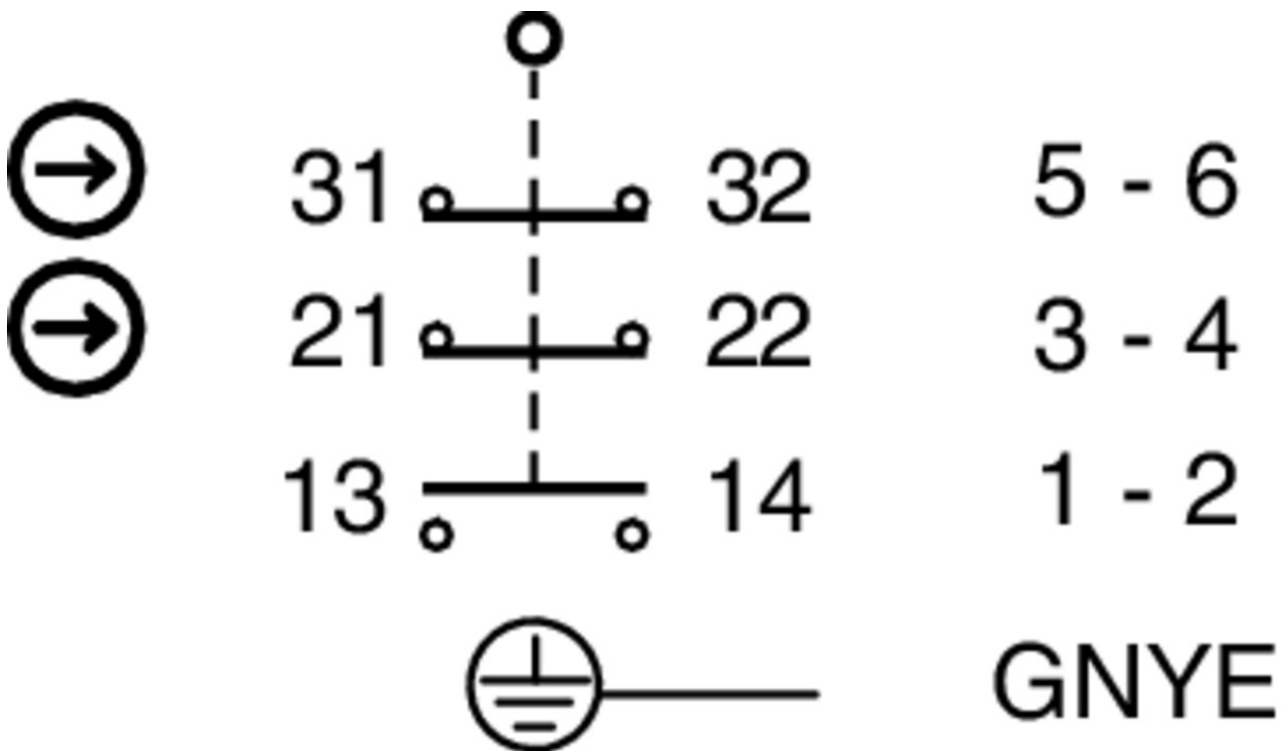

## ES12









### Instructions

- Betriebsanleitung Sicherheitsschalter EGZ

	Doc. no.	Version	Language	Download
Betriebsanleitung Sicherheitsschalter EGZ Operating Instructions Safety Switches EGZ	103013	03-03/16	 	 0.6 MB

### Catalogs

- Positionsschalter und Reihengrenztaster Position Switches and Multiple Limit Switches  
Interrupteurs de position et boîtiers multipistes

	Doc. no.	Version	Language	Download
Positionsschalter und Reihengrenztaster	157835	01-03/18		 4.1 MB
Interrupteurs de position et boîtiers multipistes	157837	01-03/18		 4.1 MB
Position Switches and Multiple Limit Switches	157836	01-03/18		 4.1 MB

### Declaration of conformity

- EU prohlášení o shodě

Doc. no.	Version	Language	Download
----------	---------	----------	----------

EU-Konformitätserklärung	2077153	25-02/17		 0.3 MB
Declaración UE de conformidad				
Déclaration UE de conformité				
Dichiarazione di conformità				
EU declaration of conformity				
EU prohlášení o shodě	2077153	25-02/17		 0.5 MB
EU-overensstemmelseserklæring				
Δήλωση συμμόρφωσης της ΕΕ				
EU-vaatimustenmukaisuusvakuutus				
EU-típusbizonyítvány				
EU-conformiteitsverklaring				
Deklaracja zgodności UE				
Declaração de Conformidade UE				
Declarația de conformitate UE				
EÚ vyhlásenie o zhode				