

ITEM 085260 SN01D558-M

| Description | Technical data | Accessories | Downloads |
|-------------|----------------|-------------|-----------|
|-------------|----------------|-------------|-----------|

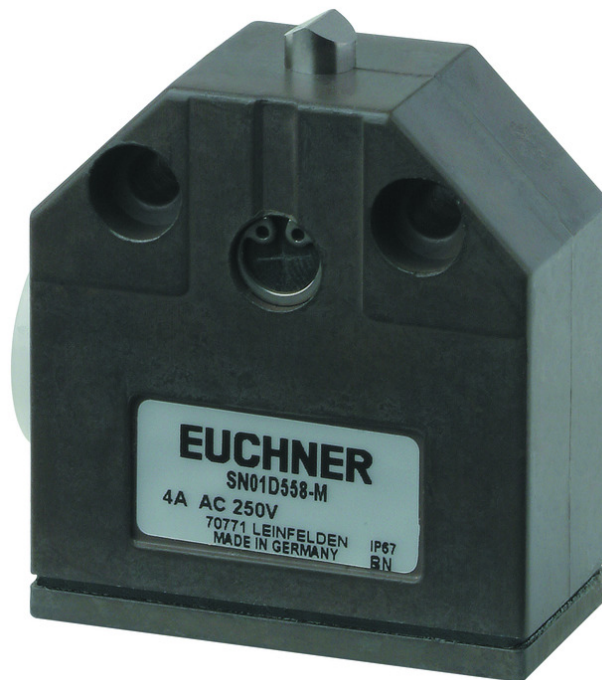

Features

- › Plunger material stainless steel

Approvals



Mechanical values and environment

| | |
|----------------------|----------------------------|
| Housing material | Anodized die-cast alloy |
| Weight | Net 0,1 kg |
| Ambient temperature | -5 ... 80 °C |
| Degree of protection | IP67 |
| Mechanical life | 10 x 10 ⁶ |
| Contact material | Silver alloy, gold flashed |

| | |
|-------------------------------------|-------------------------------|
| Switching principle | Snap-action switching contact |
| Installation position | Any |
| Number of door position NC contacts | 1 |
| Number of door position NO contacts | 1 |
| Connection | 1 x M16 x 1.5 |
| Approach speed | max. 0,01 ... 20 m/min |
| Actuating element | Chisel plunger |
| Actuating force | 15 ... 20 N |

Electrical connection ratings

| | |
|---|---------------------------------------|
| Rated thermal current I_{th} | 10 A |
| Utilization category according to EN 60947-5-1 | AC-15 4A 230V DC-13 3A 24V |
| Short circuit protection according to IEC 60269-1 | (Fuse) 10A gG |
| Rated insulation voltage U_i | 250 V |
| Rated impulse withstand voltage U_{imp} | 2,5 kV |
| Switching current | Min. at DC 5V 10 mA |
| Connection cross-section | 0,14 ... 1 mm ² [1] |

[1] Soldered connection

Dimension drawing

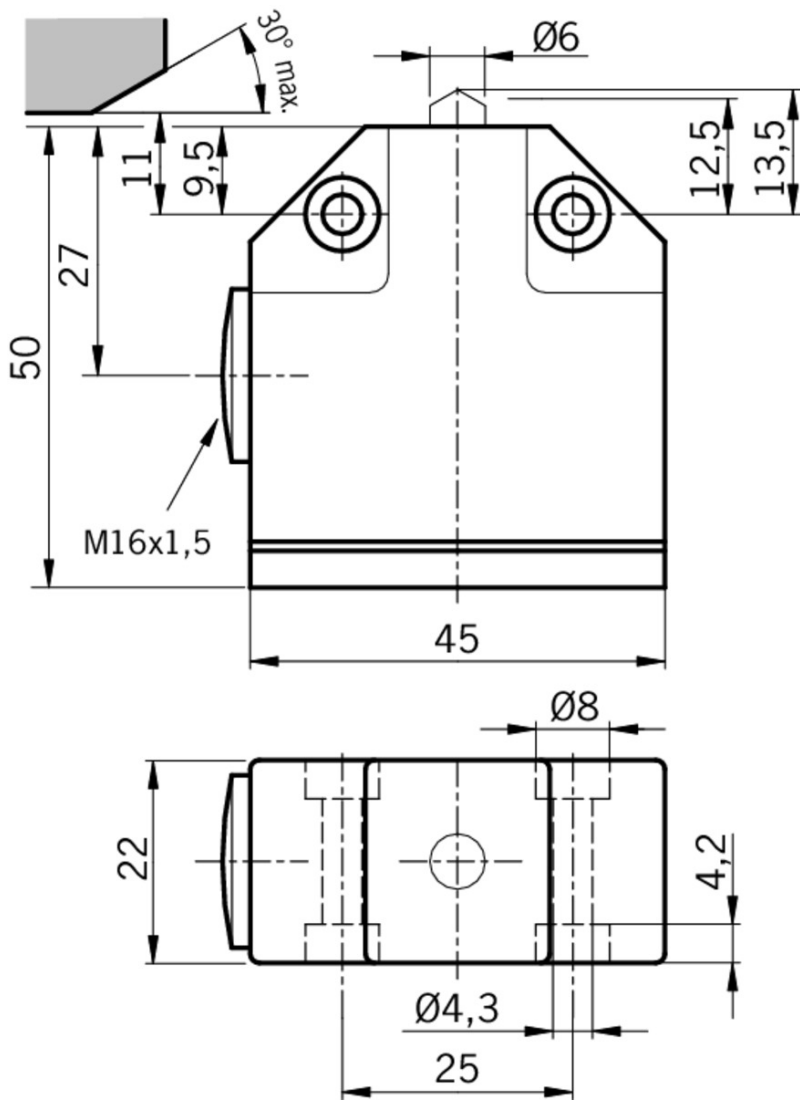

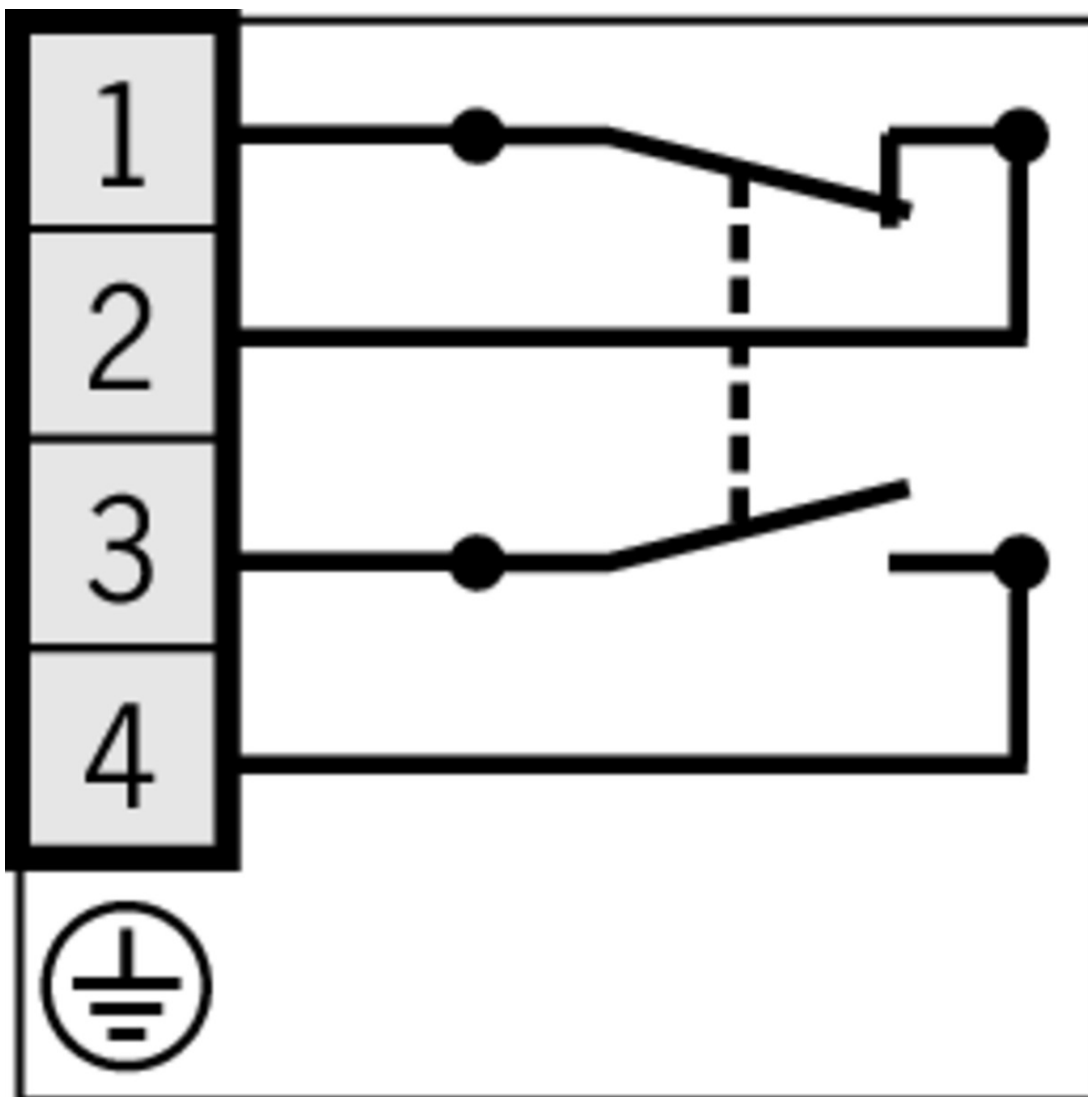







Instructions

Manual de instrucciones Finales de carrera unitarios de precisión N01/NB01/SN01

| | Doc. no. | Version | Language | Download |
|--|----------|----------|----------|----------|
| Betriebsanleitung Präzisions-Einzelgrenztaster N01/NB01/SN01 Operating Instructions Precision Single Limit Switches N01/NB01/SN01 | 2105376 | 06-02/18 | | 0.9 MB |
| Mode d'emploi Monopistes de précision N01/NB01/SN01 | 2105376 | 06-02/18 | | 0.5 MB |
| Manual de instrucciones Finales de carrera unitarios de precisión N01/NB01/SN01 | 2105376 | 06-02/18 | | 0.5 MB |
| Istruzioni di impiego Finecorsa di precisione singoli N01/NB01/SN01 | 2105376 | 06-02/18 | | 0.5 MB |

Catalogs

✓ Positionsschalter und Reihengrenztaster Position Switches and Multiple Limit Switches
Interrupteurs de position et boîtiers multipistes

| | Doc. no. | Version | Language | Download |
|---|-----------------|----------------|---|--|
| Positionsschalter und Reihengrenztaster | 157835 | 01-03/18 |  |  4.1 MB |
| Interrupteurs de position et boîtiers multipistes | 157837 | 01-03/18 |  |  4.1 MB |
| Position Switches and Multiple Limit Switches | 157836 | 01-03/18 |  |  4.1 MB |

CAD data

CAD data for this item on TraceParts