

**ITEM 085262 SN01K558-M**

Description	Technical data	Accessories	Downloads
-------------	----------------	-------------	-----------

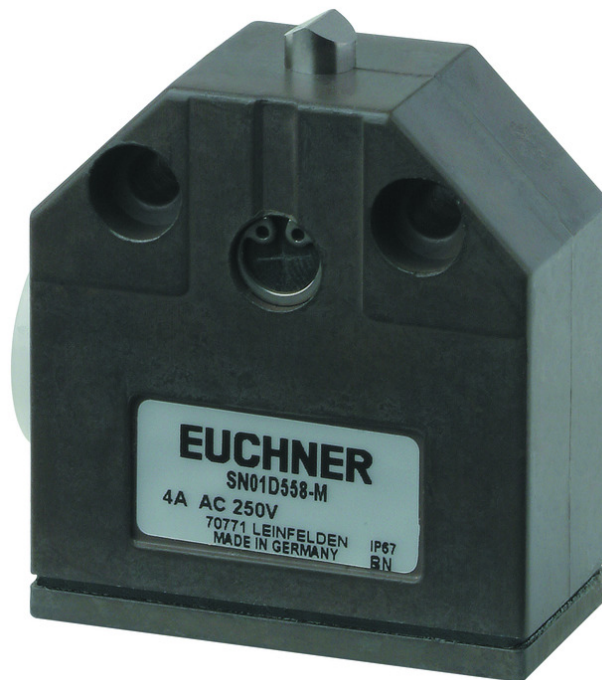

**Features**

- › Plunger material stainless steel

**Approvals**



**Mechanical values and environment**

Housing material	Anodized die-cast alloy
Weight	Net 0,1 kg
Ambient temperature	-5 ... 80 °C
Degree of protection	IP67
Mechanical life	10 x 10 <sup>6</sup>
Contact material	Silver alloy, gold flashed

Switching principle	Snap-action switching contact
Installation position	Any
Number of door position NC contacts	1
Number of door position NO contacts	1
Connection	1 x M16 x 1.5
Approach speed	max. 0,01 ... 8 m/min
Actuating element Steel ball, D ball = 4mm	Ball plunger
Actuating force	15 ... 20 N

### Electrical connection ratings

Rated thermal current $I_{th}$	10 A
Utilization category according to EN 60947-5-1	AC-15 4A 230V DC-13 3A 24V
Short circuit protection according to IEC 60269-1	(Fuse) 10A gG
Rated insulation voltage $U_i$	250 V
Rated impulse withstand voltage $U_{imp}$	2,5 kV
Switching current	Min. at DC 5V 10 mA
Connection cross-section	0,14 ... 1 mm <sup>2</sup> <b>[1]</b>

**[1]** Soldered connection

Dimension drawing

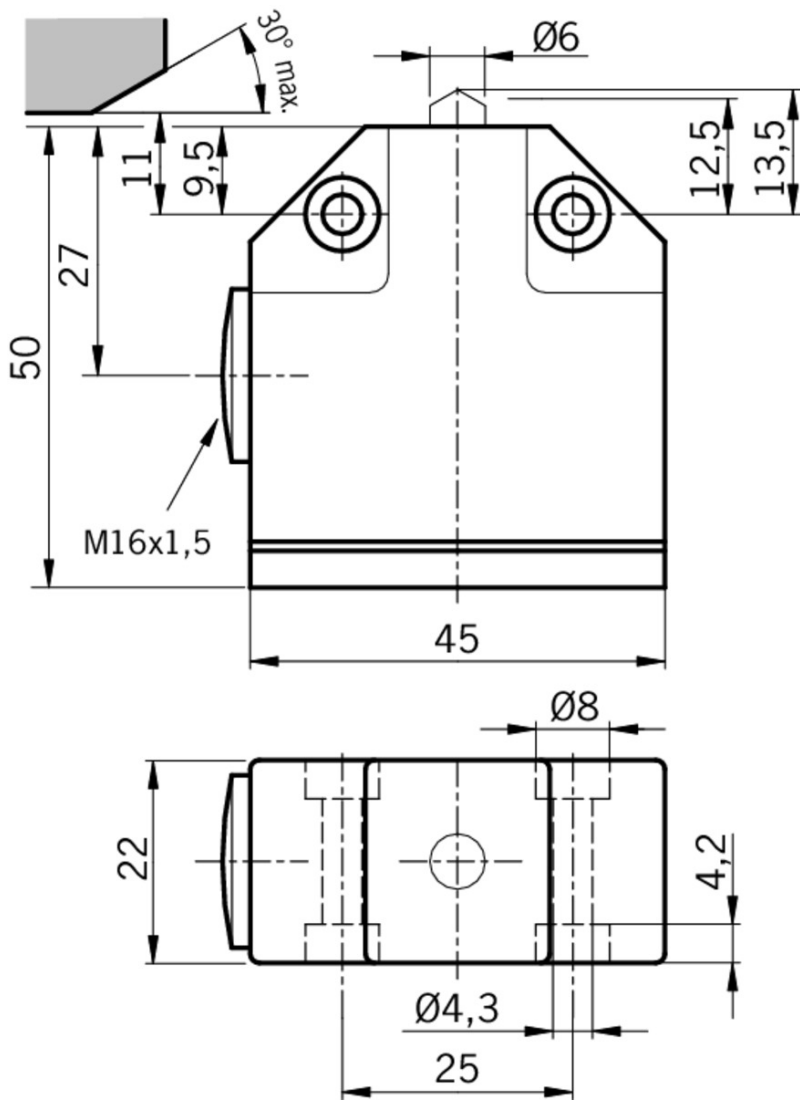

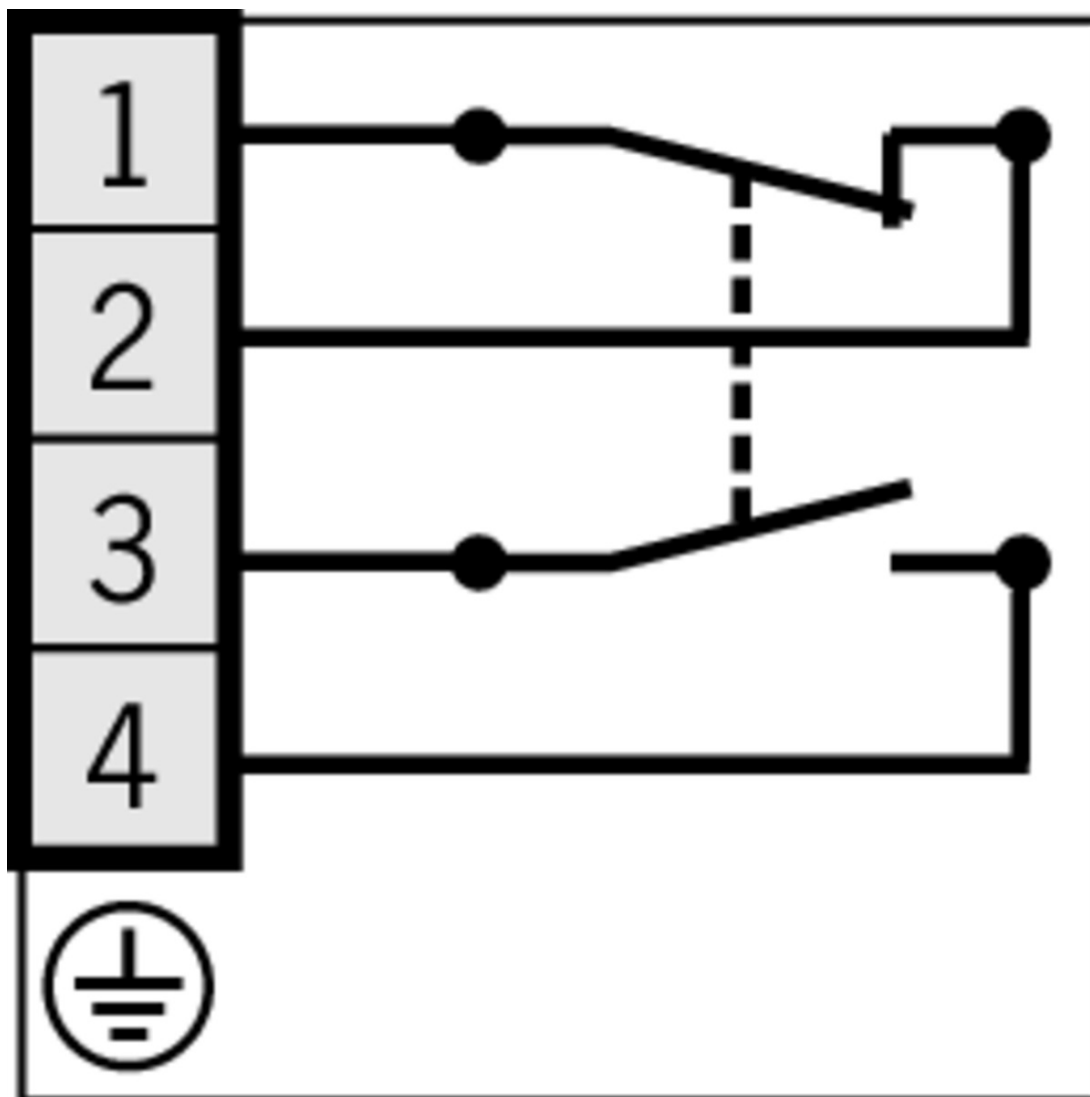







**Instructions**

Manual de instrucciones Finales de carrera unitarios de precisión N01/NB01/SN01

	Doc. no.	Version	Language	Download
Betriebsanleitung Präzisions-Einzelgrenztaster N01/NB01/SN01 Operating Instructions Precision Single Limit Switches N01/NB01/SN01	2105376	06-02/18		0.9 MB
Mode d'emploi Monopistes de précision N01/NB01/SN01	2105376	06-02/18		0.5 MB
Manual de instrucciones Finales de carrera unitarios de precisión N01/NB01/SN01	2105376	06-02/18		0.5 MB
Istruzioni di impiego Finecorsa di precisione singoli N01/NB01/SN01	2105376	06-02/18		0.5 MB

**Catalogs**

 **Positionsschalter und Reihengrenztaster** Position Switches and Multiple Limit Switches  
Interrupteurs de position et boîtiers multipistes

	<b>Doc. no.</b>	<b>Version</b>	<b>Language</b>	<b>Download</b>
Positionsschalter und Reihengrenztaster	157835	01-03/18		 4.1 MB
Interrupteurs de position et boîtiers multipistes	157837	01-03/18		 4.1 MB
Position Switches and Multiple Limit Switches	157836	01-03/18		 4.1 MB

**CAD data**

CAD data for this item on TraceParts