

ITEM 086588 SN04R12-502AM-M

Description	Technical data	Accessories	Downloads
-------------	----------------	-------------	-----------



Features

- › With exterior diaphragm
- › plunger spacing 12 mm
- › Upright housing, small flange
- › Degree of protection IP67 according to IEC 60529

Exterior diaphragm

The exterior diaphragm protects the plunger guide against the entry of very fine dust (dust from grinding, casting, glass, etc.) and prevents the plunger seizing. At the same time, plunger sticking, caused by resinous lubricating coolants, can be prevented with this exterior diaphragm version.

Switching element

ES 502 E Snap-action switching contact 1 NC + 1 NO

Approvals

Mechanical values and environment

Design		Upright
Housing material		Die-cast aluminum, anodized
Weight	Net	0,5 kg
Ambient temperature		-5 ... 80 °C
Degree of protection		IP67
Mechanical life		30 x 10 ⁶
Contact material		Silver alloy, gold flashed
Switching principle		Snap-action switching contact [1]
Plunger spacing		12 mm
Installation position		Any
Number of switching elements		4
Number of NC contacts		4
Number of NO contacts		4
Connection		2 x M20 x 1.5
Approach speed	max.	0,01 ... 50 m/min
Actuating element	Plain bearing	Roller plunger [2]
Actuating force		min.20 N

Electrical connection ratings

Rated thermal current I _{th}		8 A
Utilization category according to EN 60947-5-1		
	AC-15	6A 230V
	DC-13	6A 24V
	AC-12	8 A, 250 V
Short circuit protection according to IEC 60269-1	(Fuse)	8A gG
Rated insulation voltage U _i		250 V
Rated impulse withstand voltage U _{imp}		2,5 kV
Switching current	Min. at DC 12V	min.10 mA
Connection cross-section		0,34 ... 1,5 mm ²

Miscellaneous

Additional feature		[3]
--------------------	--	------------

[1] Contact closing time < 4 ms contact bounce time < 3 ms

[2] d roller = 5. Operating point accuracy ± 0.01 . The reproducible switching point accuracy refers to the axial travel of the plunger after the switching element ES 502 E has been run-in with approx. 2000 operating cycles.

[3] Exterior diaphragm = AM. The exterior diaphragm provides additional protection to the plunger guide. Plunger sticking, primarily caused by resinous lubricating coolants, can be prevented by this exterior diaphragm version.

Dimension drawing

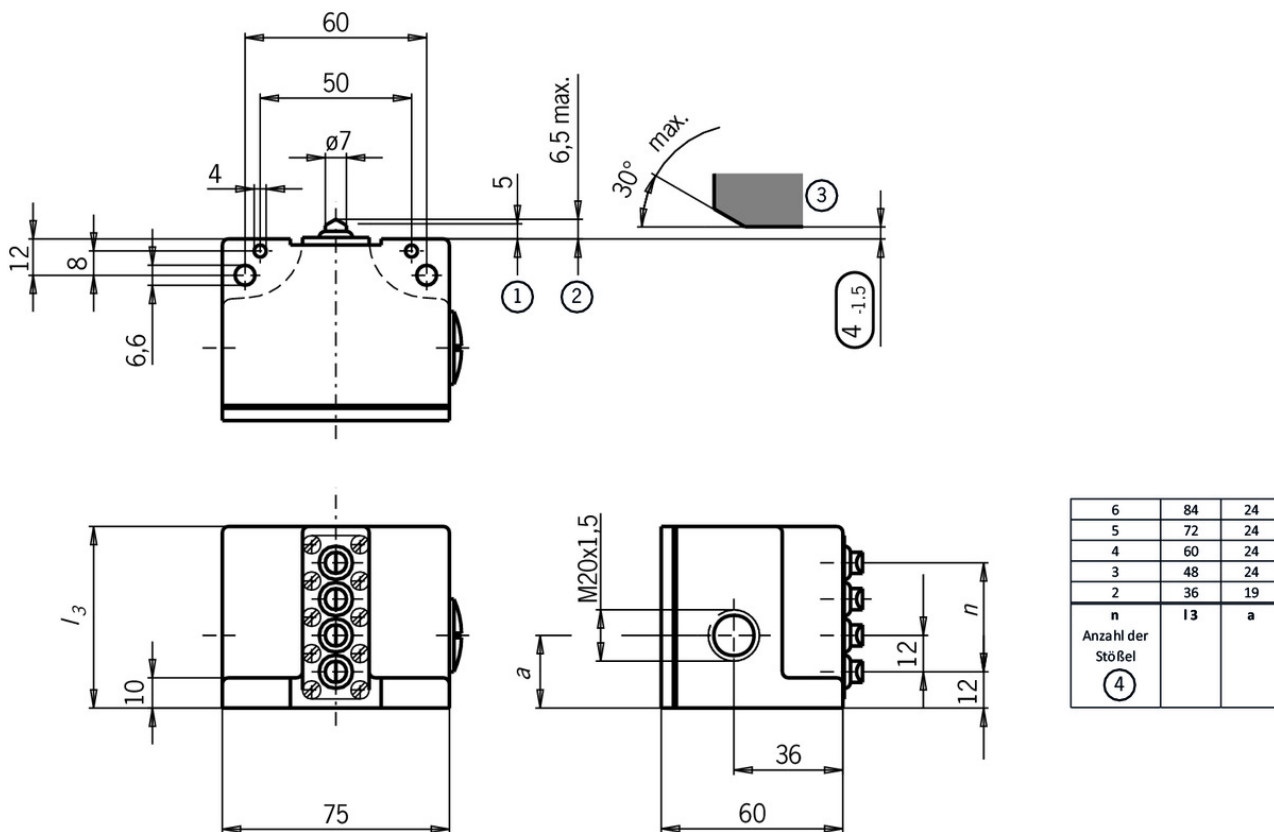

Legende

- 1 Operating point
- 2 Free position
- 3 Dog
- 4 n Number of plungers

ES 502 E

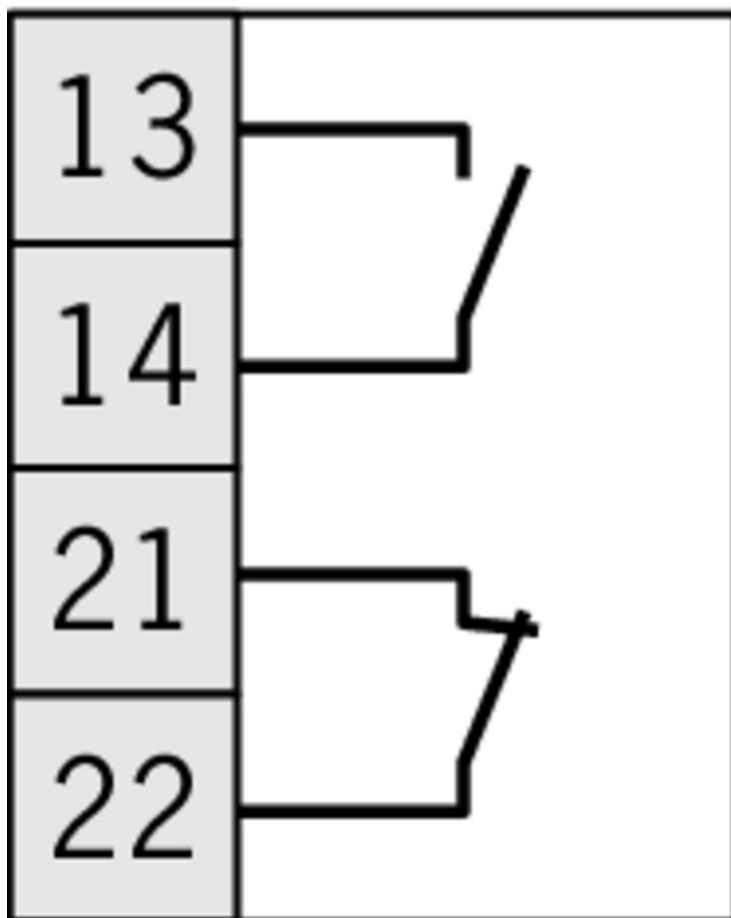

Instructions

- Betriebsanleitung Präzisions-Reihengrenztaster SN 12/16 mm

	Doc. no.	Version	Language	Download
Betriebsanleitung Präzisions-Reihengrenztaster SN 12/16 mm	032308	08-07/16		1.2 MB
Mode d'emploi Boîtiers multipistes de précision SN 12/16 mm				
Istruzioni di impiego Finecorsa multipli di precisione SN 12/16 mm				
Operating Instructions Precision Multiple Limit Switches SN 12/16 mm				

Catalogs

- Positionsschalter und Reihengrenztaster Position Switches and Multiple Limit Switches Interrupteurs de position et boîtiers multipistes

	Doc. no.	Version	Language	Download
Positionsschalter und Reihengrenztaster	157835	01-03/18		 4.1 MB
Interrupteurs de position et boîtiers multipistes	157837	01-03/18		 4.1 MB
Position Switches and Multiple Limit Switches	157836	01-03/18		 4.1 MB

CAD data

CAD data for this item on TraceParts