

ITEM 088751 SN04K16-502-M

Description	Technical data	Accessories	Downloads
-------------	----------------	-------------	-----------



Features

- › plunger spacing 16 mm
- › Upright housing, small flange
- › Degree of protection IP67 according to IEC 60529

Switching element

ES 502 E Snap-action switching contact 1 NC + 1 NO

Approvals



Mechanical values and environment

Design	Upright
Housing material	Die-cast aluminum, anodized

Weight		
	Net	0,6 kg
Ambient temperature		-5 ... 80 °C
Degree of protection		IP67
Mechanical life		30 x 10 ⁶
Contact material		Silver alloy, gold flashed
Switching principle		Snap-action switching contact [1]
Plunger spacing		16 mm
Installation position		Any
Number of switching elements		4
Number of NC contacts		4
Number of NO contacts		4
Connection		
	2 x	M20 x 1.5
Approach speed		
	max.	0,01 ... 10 m/min
Actuating element		Ball plunger [2]
Actuating force		min.20 N

Electrical connection ratings

Rated thermal current I_{th}		8 A
Utilization category according to EN 60947-5-1		
	AC-15	6A 230V
	DC-13	6A 24V
	AC-12	8 A, 250 V
Short circuit protection according to IEC 60269-1		
	(Fuse)	8A gG
Rated insulation voltage U_i		250 V
Rated impulse withstand voltage U_{imp}		2,5 kV
Switching current		
	Min. at DC 12V	min.10 mA
Connection cross-section		0,34 ... 1,5 mm ²

[1] Contact closing time < 4 contact bounce time < 3

[2] Operating point accuracy ± 0.01 . The reproducible switching point accuracy refers to the axial travel of the plunger after the switching element ES 502 E has been run-in with approx. 2000 operating cycles.

Dimension drawing

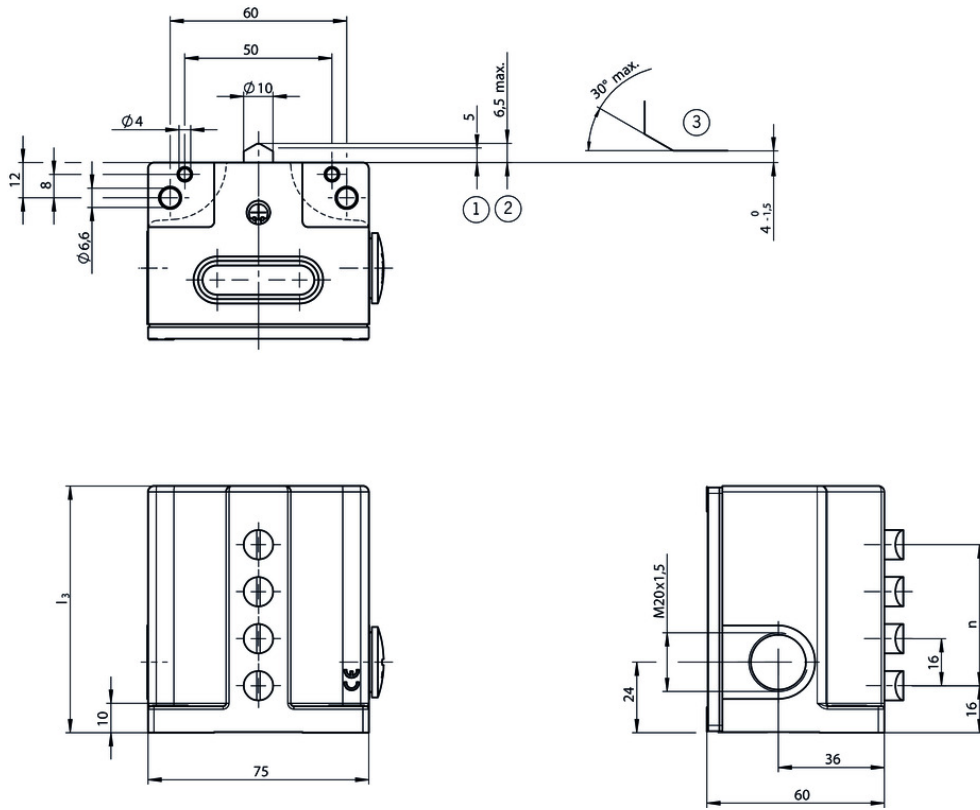

Legende

- 1 Operating point
- 2 Free position
- 3 Dog
- 4 n Number of plungers

Switching element

ES 502 E



Instructions

- Betriebsanleitung Präzisions-Reihengrenztaster SN 12/16 mm

	Doc. no.	Version	Language	Download
Betriebsanleitung Präzisions-Reihengrenztaster SN 12/16 mm	032308	08-07/16		 1.2 MB
Mode d'emploi Boîtiers multipistes de précision SN 12/16 mm				
Istruzioni di impiego Finecorsa multipli di precisione SN 12/16 mm				
Operating Instructions Precision Multiple Limit Switches SN 12/16 mm				

Catalogs

- Positionsschalter und Reihengrenztaster Position Switches and Multiple Limit Switches Interrupteurs de position et boîtiers multipistes

	Doc. no.	Version	Language	Download
Positionsschalter und Reihengrenztaster	157835	01-03/18		 4.1 MB
Interrupteurs de position et boîtiers multipistes	157837	01-03/18		 4.1 MB
Position Switches and Multiple Limit Switches	157836	01-03/18		 4.1 MB

CAD data

CAD data for this item on TraceParts