

ITEM 082318 RGBF02R12-502-M

Description	Technical data	Accessories	Downloads
-------------	----------------	-------------	-----------



Features

- › plunger spacing 12 mm
- › Upright housing according to DIN 43697
- › Degree of protection IP67 according to IEC 60529

Switching element

ES 502 E Snap-action switching contact 1 NC + 1 NO

On the usage of safety switching elements, the dog distance $\text{\textcircled{5.1.5}}$ must be maintained to achieve the positively driven travel. The dogs must be positively mounted according to EN 1088, i.e. riveted, welded or secured in some other way against becoming loose.

Approvals

Mechanical values and environment

Design	Upright, according to DIN 43697	
Housing material	Die-cast aluminum, anodized	
Weight	Net	0,85 kg
Ambient temperature	-5 ... 80 °C	
Degree of protection	IP67	
Mechanical life	30 x 10 ⁶	
Contact material	Silver alloy, gold flashed	
Switching principle	Snap-action switching contact [1]	
Plunger spacing	12 mm	
Installation position	Any	
Number of switching elements	2	
Number of NC contacts	2	
Number of NO contacts	2	
Connection	4 x M25 x 1.5	
Approach speed	max.	0,01 ... 80 m/min
Actuating element	Plain bearing	Roller plunger [2]
Actuating force	min.20 N	

Electrical connection ratings

Rated thermal current I _{th}	8 A	
Utilization category according to EN 60947-5-1	AC-15	6A 230V
	DC-13	6A 24V
	AC-12	8 A, 250 V
Short circuit protection according to IEC 60269-1	(Fuse)	8A gG
Rated insulation voltage U _i	250 V	
Rated impulse withstand voltage U _{imp}	2,5 kV	
Switching current	Min. at DC 12V	min.10 mA
Connection cross-section	0,34 ... 1,5 mm ²	

[1] Contact closing time < 4 contact bounce time < 3

[2] Operating point accuracy ± 0.01 . The reproducible switching point accuracy refers to the axial travel of the plunger after the switching element ES 502 E has been run-in with approx. 2000 operating cycles.

Dimension drawing

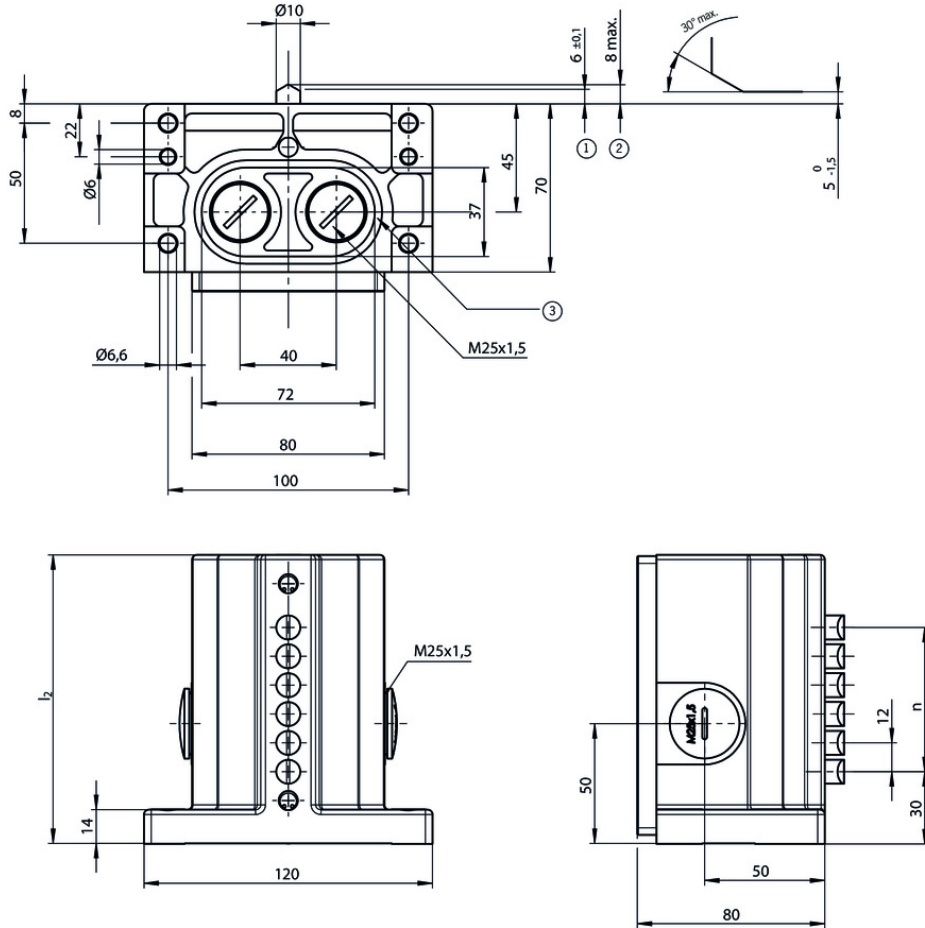

16	240
14	240
12	200
10	170
8	140
6	120
5	105
4	90
3	80
2	70
n ④	l ₂

Legende

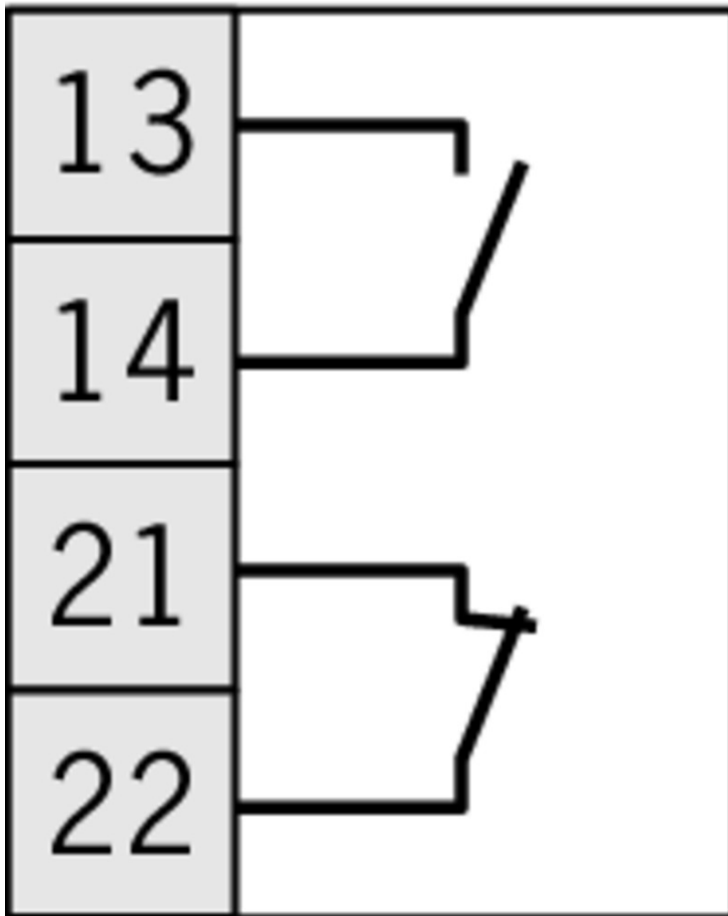

- 1 Operating point
- 2 Free position
- 3 Groove for sealing ring
- 4 Number of plungers

ES 502 E









Instructions

- ✓ Betriebsanleitung Präzisions-Reihengrenztaster RG, GS, GL 12/16 mm

	Doc. no.	Version	Language	Download
Betriebsanleitung Präzisions-Reihengrenztaster RG, GS, GL 12/16 mm	032307	07-07/16		 1.4 MB
Mode d'emploi Boîtiers multipistes de précision RG, GS, GL 12/16 mm				
Istruzioni di impiego Finecorsa multipli di precisione RG, GS, GL12/16 mm				
Operating Instructions Precision Multiple Limit Switches RG, GS, GL12/16 mm				

Catalogs

- ✓ Positionsschalter und Reihengrenztaster Position Switches and Multiple Limit Switches Interrupteurs de position et boîtiers multipistes

	Doc. no.	Version	Language	Download
Positionsschalter und Reihengrenztaster	157835	01-03/18		 4.1 MB
Interrupteurs de position et boîtiers multipistes	157837	01-03/18		 4.1 MB
Position Switches and Multiple Limit Switches	157836	01-03/18		 4.1 MB

CAD data

CAD data for this item on TraceParts