

ITEM 085955 GLBF02R16-502-M

Description	Technical data	Accessories	Downloads
-------------	----------------	-------------	-----------



Features

- › plunger spacing 16 mm
- › Horizontal housing
- › Degree of protection IP67 according to IEC 60529

Switching element

ES 502 E Snap-action switching contact 1 NC + 1 NO

Approvals



Mechanical values and environment

Design	Horizontal
Housing material	Sand-cast aluminum, anodized

Weight		
	Net	1,4 kg
Ambient temperature		-5 ... 80 °C
Degree of protection		IP67
Mechanical life		30 x 10 ⁶
Contact material		Silver alloy, gold flashed
Switching principle		Snap-action switching contact [1]
Plunger spacing		16 mm
Installation position		Any
Number of switching elements		2
Number of NC contacts		2
Number of NO contacts		2
Connection		
		3 x M25 x 1.5
Approach speed		
	max.	0,01 ... 80 m/min
Actuating element		
	Plain bearing	Roller plunger [2]
Actuating force		min.20 N

Electrical connection ratings

Rated thermal current I _{th}		8 A
Utilization category according to EN 60947-5-1		
	AC-15	6A 230V
	DC-13	6A 24V
	AC-12	8 A, 250 V
Short circuit protection according to IEC 60269-1		
	(Fuse)	8A gG
Rated insulation voltage U _i		250 V
Rated impulse withstand voltage U _{imp}		2,5 kV
Switching current		
	Min. at DC 12V	min.10 mA
Connection cross-section		0,34 ... 1,5 mm ²

[1] Contact closing time < 4 ms contact bounce time < 3 ms

[2] Operating point accuracy ± 0.01. The reproducible switching point accuracy refers to the axial travel of the plunger after the switching element ES 502 E has been run-in with approx. 2000 operating cycles.

Dimension drawing

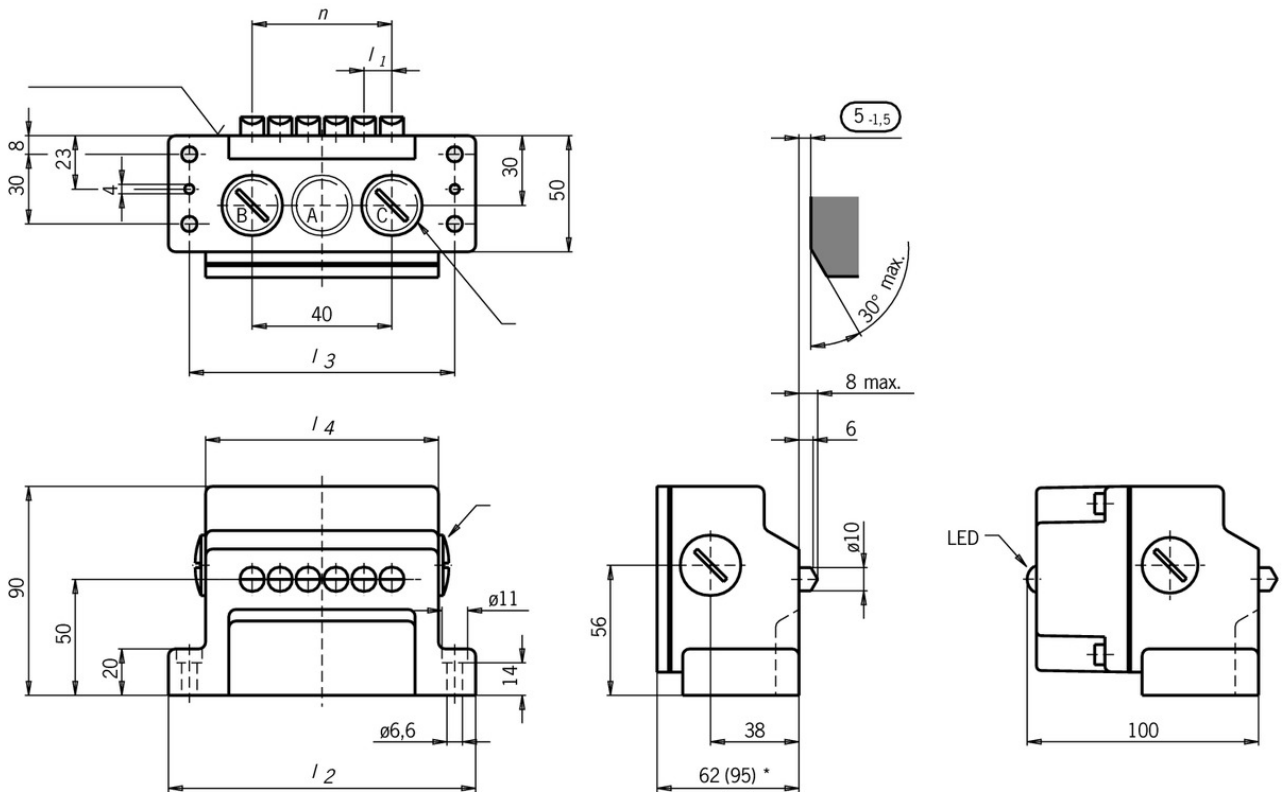

ES 502 E



Instructions

- Betriebsanleitung Präzisions-Reihengrenztaster RG, GS, GL 12/16 mm

	Doc. no.	Version	Language	Download
Betriebsanleitung Präzisions-Reihengrenztaster RG, GS, GL 12/16 mm	032307	07-07/16		1.4 MB
Mode d'emploi Boîtiers multipistes de précision RG, GS, GL 12/16 mm				
Istruzioni di impiego Finecorsa multipli di precisione RG, GS, GL12/16 mm				
Operating Instructions Precision Multiple Limit Switches RG, GS, GL12/16 mm				

Catalogs

- Positionsschalter und Reihengrenztaster Position Switches and Multiple Limit Switches Interrupteurs de position et boîtiers multipistes

	Doc. no.	Version	Language	Download
Positionsschalter und Reihengrenztaster	157835	01-03/18		 4.1 MB
Interrupteurs de position et boîtiers multipistes	157837	01-03/18		 4.1 MB
Position Switches and Multiple Limit Switches	157836	01-03/18		 4.1 MB

CAD data

CAD data for this item on TraceParts