

ITEM 086577 GLBF02D08-552-M

Description	Technical data	Accessories	Downloads
-------------	----------------	-------------	-----------



Features

- › plunger spacing 8 mm
- › Horizontal housing
- › Degree of protection IP67 according to IEC 60529

Switching element

ES Snap-action switching contact 1 changeover contact standard
552 switching element

Approvals



Mechanical values and environment

Design	Horizontal
--------	------------

Housing material	Sand-cast aluminum, anodized
Weight	
Net	0,7 kg
Ambient temperature	-5 ... 80 °C
Degree of protection	IP67
Mechanical life	10×10^6
Contact material	Silver alloy, electro-gold-plated
Switching principle	Snap-action switching contact [1]
Plunger spacing	8 mm
Installation position	Any
Tightening torque	
Screw terminal switching element	Hexagon socket AF 1.3 mm max. 0,2 Nm
Number of switching elements	2
Number of changeover contacts	2
Connection	
	3 x M20 x 1.5
Approach speed	
max.	0,01 ... 20 m/min [2]
Actuating element	Chisel plunger [3]
Actuating force	min. 15 N

Electrical connection ratings

Rated thermal current I_{th}	6 A
Utilization category according to EN 60947-5-1	
AC-15	2A 230V
DC-13	2A 24V
Short circuit protection according to IEC 60269-1	
(Fuse)	6A gG
Rated insulation voltage U_i	250 V
Rated impulse withstand voltage U_{imp}	2,5 kV
Switching current	
Min. at DC 24V	min. 10 mA
Connection cross-section	0,14 ... 1,0 mm ²

[1] Contact bounce time ≤ 2 ms

[2] The approach speed specified applies in conjunction with EUCHNER trip dogs in accordance with DIN 69639.

[3] Operating point accuracy ± 0.02 . The reproducible switching point accuracy refers to the axial travel of the plunger after the switching element ES 552 has been run-in with approx. 2000 operating cycles.

Dimension drawing

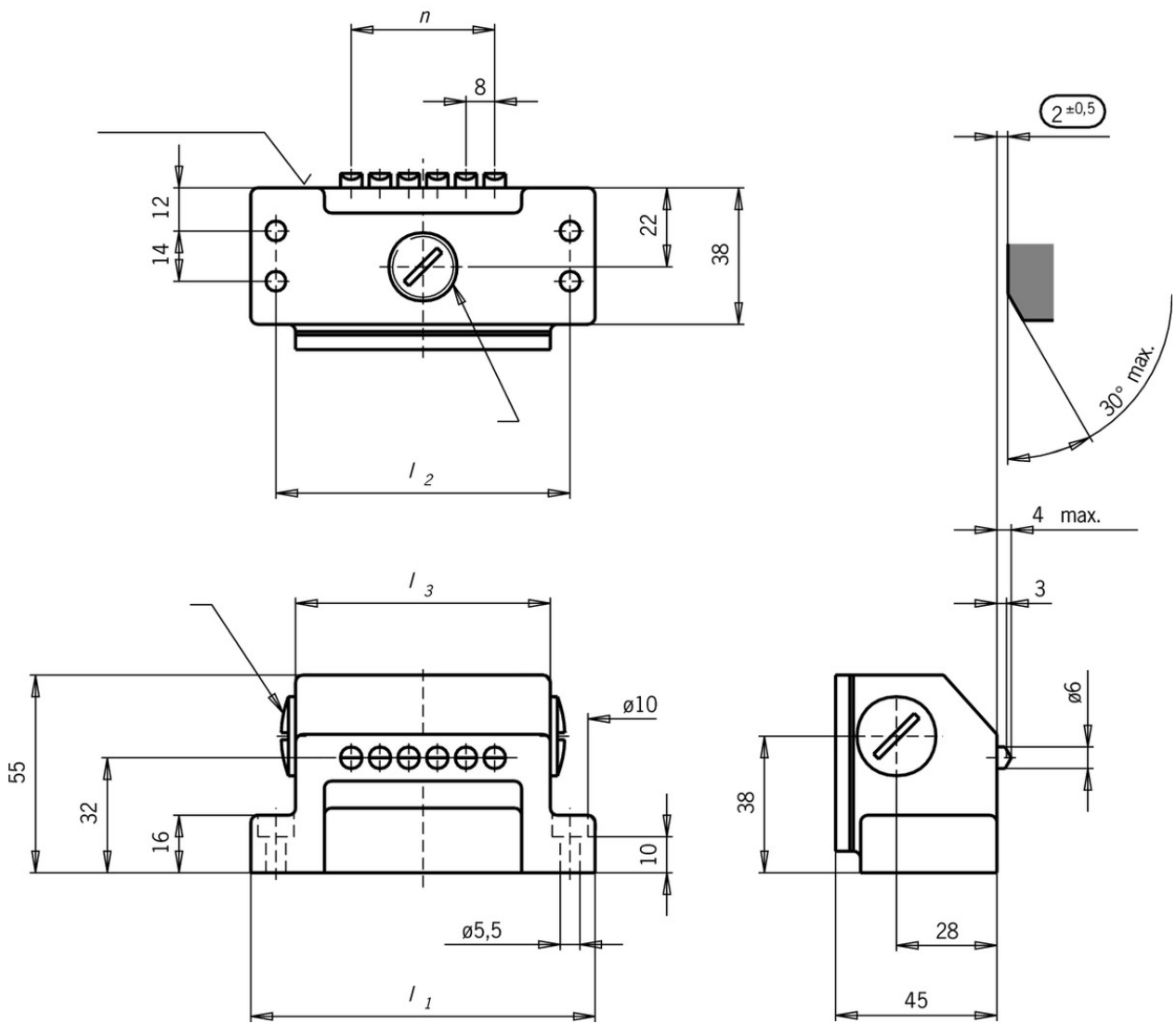

ES 552



Instructions

- Betriebsanleitung Präzisions-Reihengrenztaster GL, GS, SB, SN 8 mm

	Doc. no.	Version	Language	Download
Betriebsanleitung Präzisions-Reihengrenztaster GL, GS, SB, SN 8 mm	2076050	05-01/18		0.6 MB
Mode d'emploi Boîtiers multipistes de précision GL, GS, SB, SN 8 mm				
Istruzioni di impiego Finecorsa multipli di precisione GL, GS, SB, SN 8 mm				
Operating Instructions Precision Multiple Limit Switches GL, GS, SB, SN 8 mm				

Catalogs

- Positionsschalter und Reihengrenztaster Position Switches and Multiple Limit Switches
Interrupteurs de position et boîtiers multipistes

	Doc. no.	Version	Language	Download
Positionsschalter und Reihengrenztaster	157835	01-03/18		 4.1 MB
Interrupteurs de position et boîtiers multipistes	157837	01-03/18		 4.1 MB
Position Switches and Multiple Limit Switches	157836	01-03/18		 4.1 MB

CAD data

CAD data for this item on TraceParts