

ITEM 088374 GLBF04R16-502-M

| Description | Technical data | Accessories | Downloads |
|-------------|----------------|-------------|-----------|
|-------------|----------------|-------------|-----------|



Features

- › plunger spacing 16 mm
- › Horizontal housing
- › Degree of protection IP67 according to IEC 60529

Switching element

ES 502 E Snap-action switching contact 1 NC + 1 NO

Approvals



Mechanical values and environment

| | |
|------------------|------------------------------|
| Design | Horizontal |
| Housing material | Sand-cast aluminum, anodized |

| | | |
|------------------------------|---------------|--|
| Weight | | |
| | Net | 2 kg |
| Ambient temperature | | -5 ... 80 °C |
| Degree of protection | | IP67 |
| Mechanical life | | 30 x 10 ⁶ |
| Contact material | | Silver alloy, gold flashed |
| Switching principle | | Snap-action switching contact [1] |
| Plunger spacing | | 16 mm |
| Installation position | | Any |
| Number of switching elements | | 4 |
| Number of NC contacts | | 4 |
| Number of NO contacts | | 4 |
| Connection | | |
| | 4 x | M25 x 1.5 |
| Approach speed | | |
| | max. | 0,01 ... 80 m/min |
| Actuating element | | |
| | Plain bearing | Roller plunger [2] |
| Actuating force | | min.20 N |

Electrical connection ratings

| | | |
|---|----------------|------------------------------|
| Rated thermal current I _{th} | | 8 A |
| Utilization category according to EN 60947-5-1 | | |
| | AC-15 | 6A 230V |
| | DC-13 | 6A 24V |
| | AC-12 | 8 A, 250 V |
| Short circuit protection according to IEC 60269-1 | | |
| | (Fuse) | 8A gG |
| Rated insulation voltage U _i | | 250 V |
| Rated impulse withstand voltage U _{imp} | | 2,5 kV |
| Switching current | | |
| | Min. at DC 12V | min.10 mA |
| Connection cross-section | | 0,34 ... 1,5 mm ² |

[1] Contact closing time < 4 ms contact bounce time < 3 ms

[2] Operating point accuracy ± 0.01. The reproducible switching point accuracy refers to the axial travel of the plunger after the switching element ES 502 E has been run-in with approx. 2000 operating cycles.

Dimension drawing

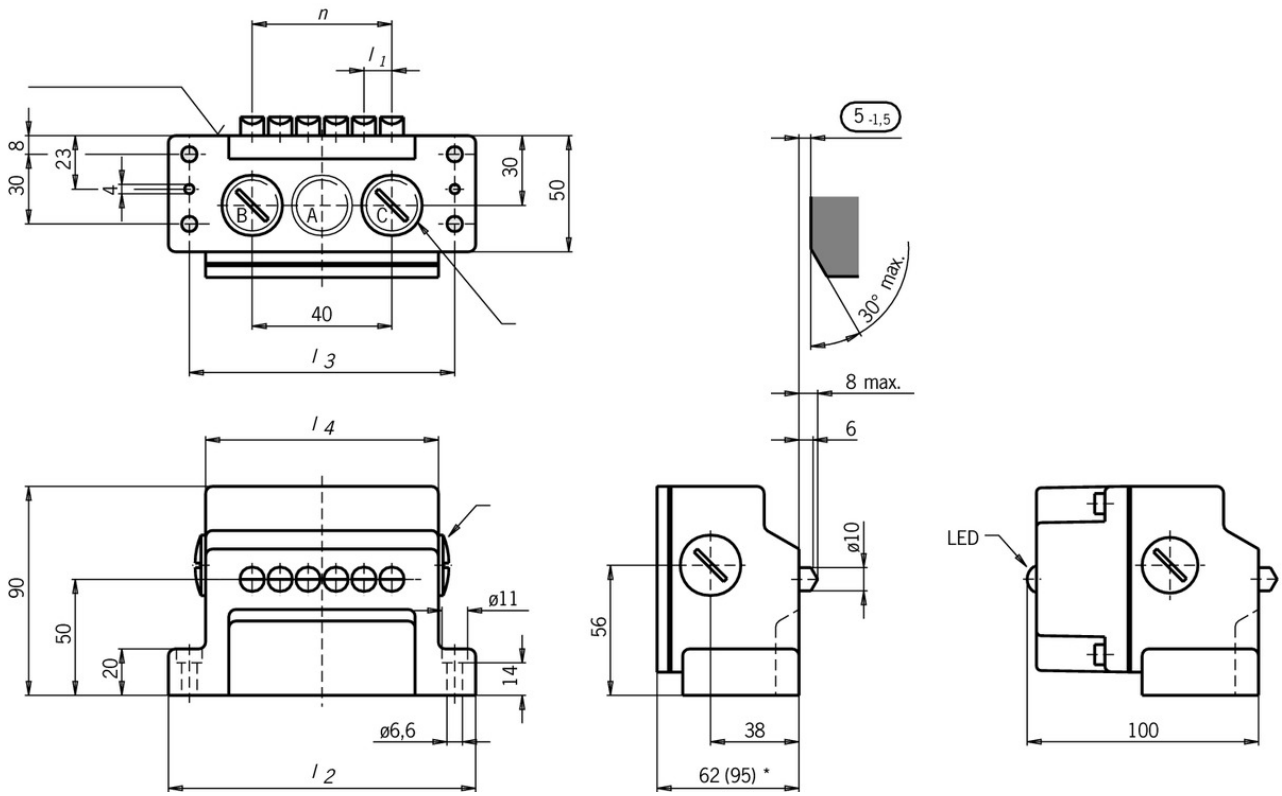

ES 502 E

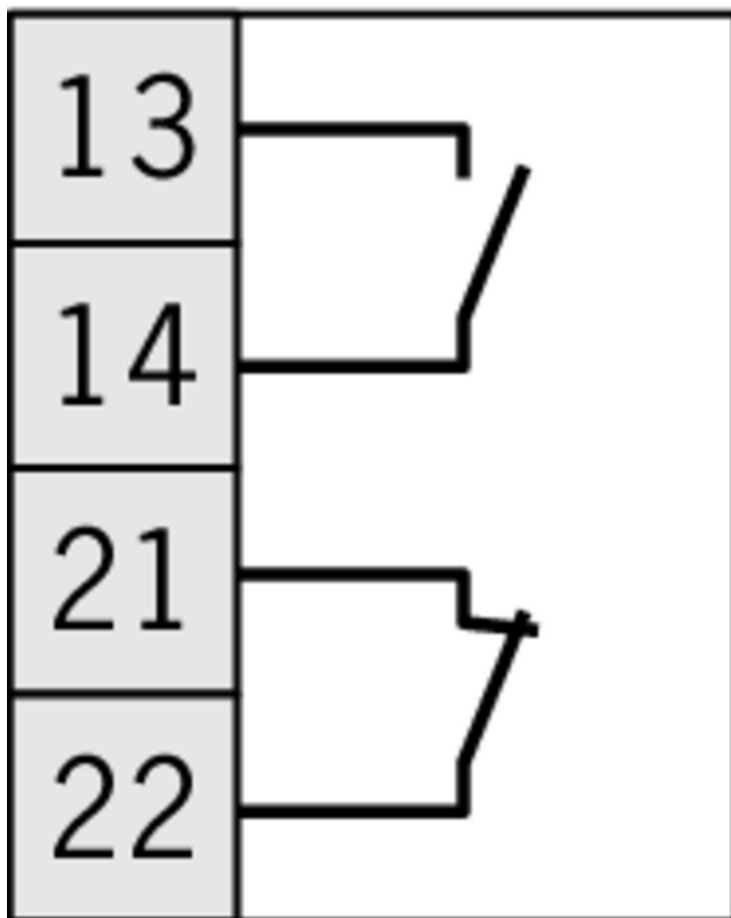







Instructions

- Betriebsanleitung Präzisions-Reihengrenztaster RG, GS, GL 12/16 mm

| | Doc. no. | Version | Language | Download |
|---|----------|----------|----------|----------|
| Betriebsanleitung Präzisions-Reihengrenztaster RG, GS, GL 12/16 mm | 032307 | 07-07/16 | | 1.4 MB |
| Mode d'emploi Boîtiers multipistes de précision RG, GS, GL 12/16 mm | | | | |
| Istruzioni di impiego Finecorsa multipli di precisione RG, GS, GL12/16 mm | | | | |
| Operating Instructions Precision Multiple Limit Switches RG, GS, GL12/16 mm | | | | |

Catalogs

- Positionsschalter und Reihengrenztaster Position Switches and Multiple Limit Switches Interrupteurs de position et boîtiers multipistes

| | Doc. no. | Version | Language | Download |
|---|-----------------|----------------|---|--|
| Positionsschalter und Reihengrenztaster | 157835 | 01-03/18 |  |  4.1 MB |
| Interrupteurs de position et boîtiers multipistes | 157837 | 01-03/18 |  |  4.1 MB |
| Position Switches and Multiple Limit Switches | 157836 | 01-03/18 |  |  4.1 MB |

CAD data

CAD data for this item on TraceParts