

ITEM 091161 GLBF06R12-514-M

Description	Technical data	Accessories	Downloads
-------------	----------------	-------------	-----------



Features

- › plunger spacing 12 mm
- › Horizontal housing
- › Degree of protection IP67 according to IEC 60529

Switching element

ES 514 Snap-action switching contact 1 NC \rightarrow + 1 NO

On the usage of safety switching elements, the dog distance (4.0.5) must be maintained to achieve the positively driven travel. The dogs must be positively mounted according to EN ISO 14119, i.e. riveted, welded or secured in some other way against becoming loose.

Approvals



Mechanical values and environment

Design	Horizontal
Housing material	Sand-cast aluminum, anodized
Weight	
Net	2,5 kg
Ambient temperature	-5 ... 80 °C
Degree of protection	IP67
Mechanical life	1×10^6
Contact material	Silver alloy, gold flashed
Switching principle	Snap-action switching contact [1]
Plunger spacing	12 mm
Installation position	Any
Number of switching elements	6
Number of positively driven contacts	6
Number of NO contacts	6
Connection	
	4 x M25 x 1.5
Approach speed	
max.	0,01 ... 80 m/min
Actuating element	
Plain bearing	Roller plunger
Actuating force	min.30 N

Electrical connection ratings

Rated thermal current I_{th}	10 A
Utilization category according to EN 60947-5-1	
AC-15	2.5A 230V
DC-13	6A 24V
Short circuit protection according to IEC 60269-1	
(Fuse)	6A gG
Rated insulation voltage U_i	250 V
Rated impulse withstand voltage U_{imp}	4 kV
Switching current	
Min. at DC 24V	min.5 mA
Connection cross-section	0,34 ... 1,5 mm ²

Reliability values acc. to EN ISO 13849-1

B10 _D	2×10^6
------------------	-----------------

[1] Contact closing time ≤ 5 ms contact bounce time ≤ 3 ms

Dimension drawing

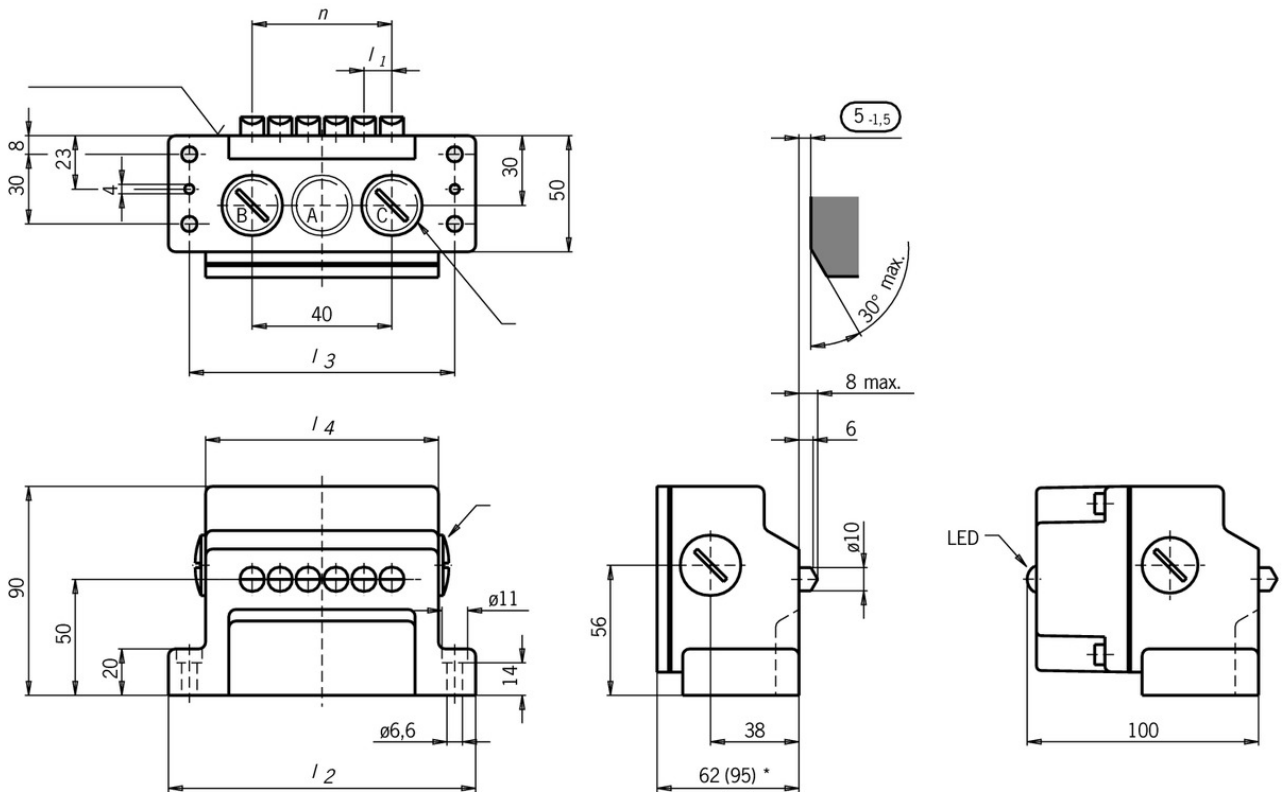

ES 514

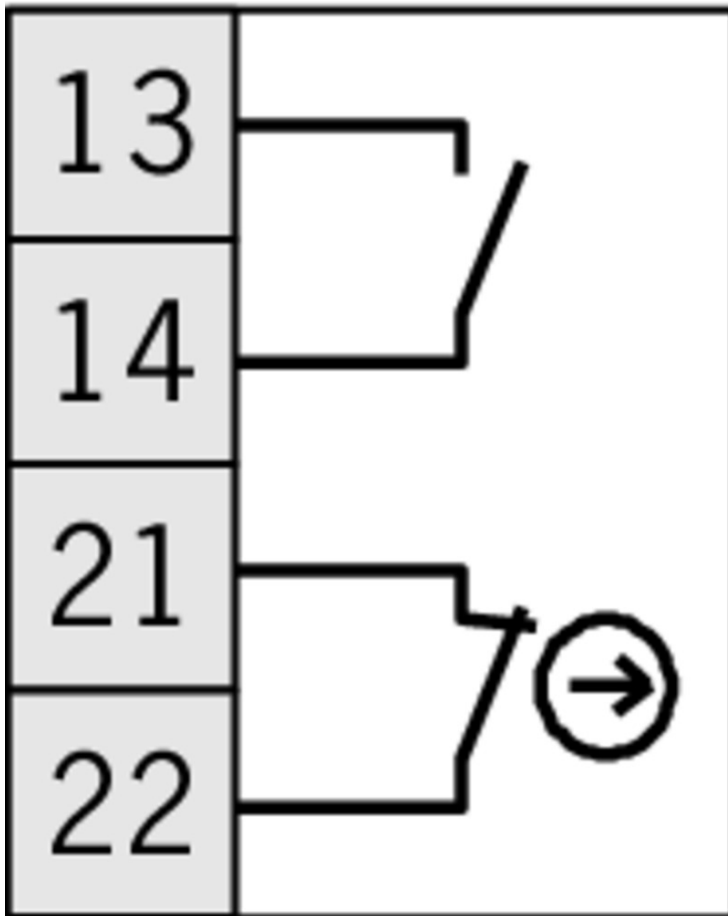

Instructions

Betriebsanleitung Präzisions-Reihengrenztaster RG, GS, GL 12/16 mm

	Doc. no.	Version	Language	Download
Betriebsanleitung Präzisions-Reihengrenztaster RG, GS, GL 12/16 mm	032307	07-07/16		1.4 MB
Mode d'emploi Boîtiers multipistes de précision RG, GS, GL 12/16 mm				
Istruzioni di impiego Finecorsa multipli di precisione RG, GS, GL12/16 mm				
Operating Instructions Precision Multiple Limit Switches RG, GS, GL12/16 mm				

Declaration of conformity

EU prohlášení o shodě

Doc. no. Version Language Download

EU-Konformitätserklärung	2077153	25-02/17		 0.3 MB
Declaración UE de conformidad				
Déclaration UE de conformité				
Dichiarazione di conformità				
EU declaration of conformity				
EU prohlášení o shodě	2077153	25-02/17		 0.5 MB
EU-overensstemmelseserklæring				
Δήλωση συμμόρφωσης της ΕΕ				
EU-vaatimustenmukaisuusvakuutus				
EU-típusbizonyítvány				
EU-conformiteitsverklaring				
Deklaracja zgodności UE				
Declaração de Conformidade UE				
Declarația de conformitate UE				
EÚ vyhlásenie o zhode				

CAD data

CAD data for this item on TraceParts