

ITEM 085992 GLBF04R08-552-M

Description	Technical data	Accessories	Downloads
-------------	----------------	-------------	-----------



Features

- › plunger spacing 8 mm
- › Horizontal housing
- › Degree of protection IP67 according to IEC 60529

Switching element

ES Snap-action switching contact 1 changeover contact standard
552 switching element

Approvals



Mechanical values and environment

Design	Horizontal
--------	------------

Housing material	Sand-cast aluminum, anodized	
Weight		
	Net	0,8 kg
Ambient temperature	-5 ... 80 °C	
Degree of protection	IP67	
Mechanical life	10 x 10 ⁶	
Contact material	Silver alloy, electro-gold-plated	
Switching principle	Snap-action switching contact [1]	
Plunger spacing	8 mm	
Installation position	Any	
Tightening torque		
	Screw terminal switching element	Hexagon socket AF 1.3 mmmax.0,2 Nm
Number of switching elements	4	
Number of changeover contacts	4	
Connection		
		3 x M20 x 1.5
Approach speed		
	max.	0,01 ... 50 m/min [2]
Actuating element		
	Plain bearing	Roller plunger [3]
Actuating force	min.15 N	

Electrical connection ratings

Rated thermal current I _{th}	6 A	
Utilization category according to EN 60947-5-1		
	AC-15	2A 230V
	DC-13	2A 24V
Short circuit protection according to IEC 60269-1		
	(Fuse)	6A gG
Rated insulation voltage U _i	250 V	
Rated impulse withstand voltage U _{imp}	2,5 kV	
Switching current		
	Min. at DC 24V	min.10 mA
Connection cross-section	0,14 ... 1,0 mm ²	

[1] Contact bounce time ≤ 2 ms

[2] The approach speed specified applies in conjunction with EUCHNER trip dogs in accordance with DIN 69639.

[3] Operating point accuracy ± 0.05. The reproducible switching point accuracy refers to the axial travel of the plunger after the switching element ES 552 has been run-in with approx. 2000 operating cycles.

Dimension drawing

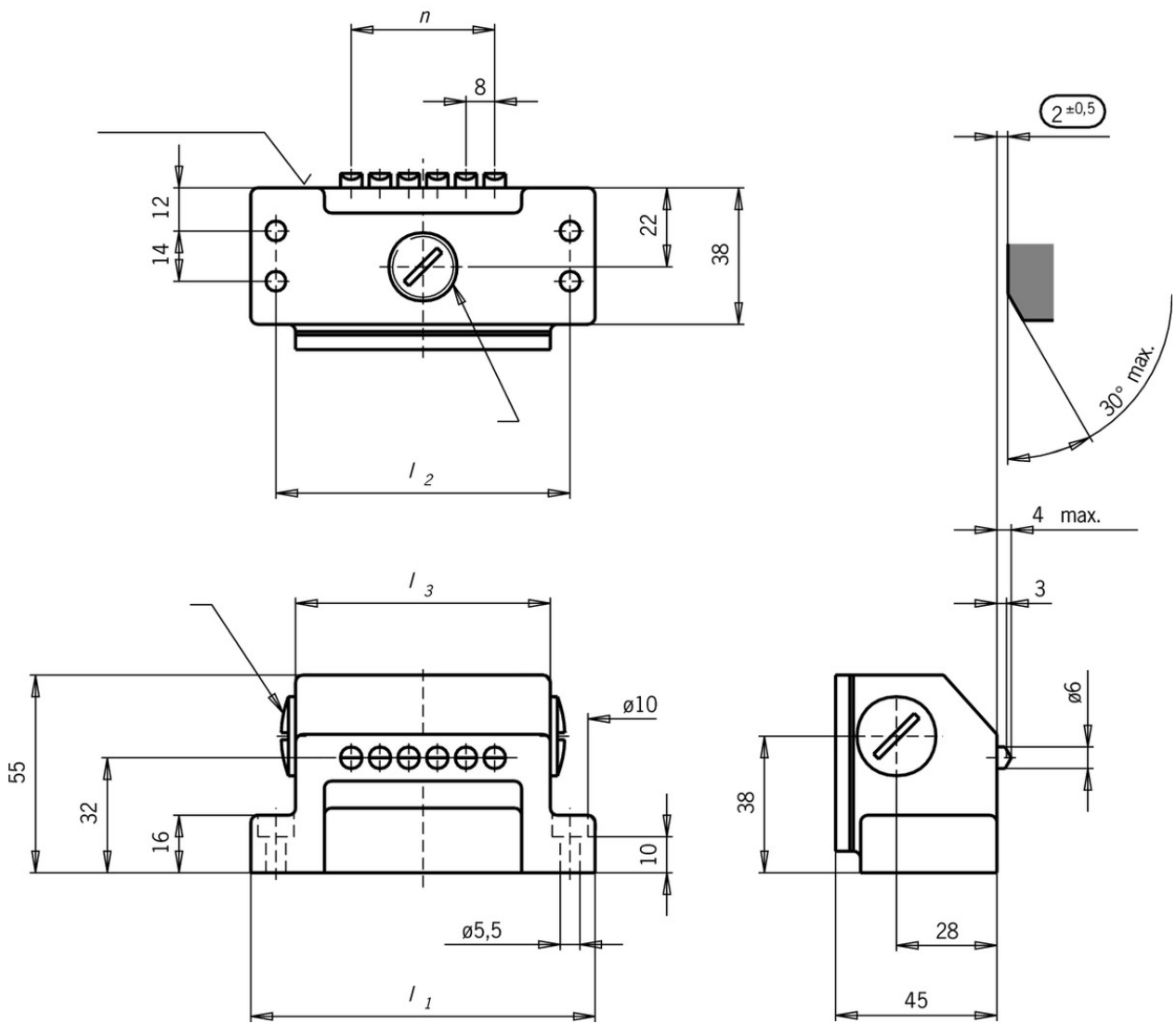

ES 552



Instructions

- Betriebsanleitung Präzisions-Reihengrenztaster GL, GS, SB, SN 8 mm

	Doc. no.	Version	Language	Download
Betriebsanleitung Präzisions-Reihengrenztaster GL, GS, SB, SN 8 mm	2076050	05-01/18		0.6 MB
Mode d'emploi Boîtiers multipistes de précision GL, GS, SB, SN 8 mm				
Istruzioni di impiego Finecorsa multipli di precisione GL, GS, SB, SN 8 mm				
Operating Instructions Precision Multiple Limit Switches GL, GS, SB, SN 8 mm				

Catalogs

- Positionsschalter und Reihengrenztaster Position Switches and Multiple Limit Switches
Interrupteurs de position et boîtiers multipistes

	Doc. no.	Version	Language	Download
Positionsschalter und Reihengrenztaster	157835	01-03/18		 4.1 MB
Interrupteurs de position et boîtiers multipistes	157837	01-03/18		 4.1 MB
Position Switches and Multiple Limit Switches	157836	01-03/18		 4.1 MB

CAD data

CAD data for this item on TraceParts