

ITEM 093166 GLBF02R12-502-MC2050

Description	Technical data	Accessories	Downloads
-------------	----------------	-------------	-----------



Features

- › Plunger spacing 12 or 16 mm
- › Horizontal housing
- › Degree of protection IP67 according to IEC 60529
- › LED function display optional

Switching elements

ES 502 E Snap-action switching contact 1 NC + 1 NO

ES 508 Slow-action switching contact 1 NC \rightarrow

ES 514 Snap-action switching contact 1 NC \rightarrow + 1 NO

On the usage of safety switching elements, the dog distance (4.0.5) must be maintained to achieve the positively driven travel. The dogs must be positively mounted according to EN 1088, i.e. riveted, welded or secured in some other way against becoming loose.

LED function display (optional)

Function displays are available for the following voltage ranges (see accessories)

LE060 12 ... 60 V AC/DC

LE110 110 V AC \pm 15%

Approvals



Mechanical values and environment

Contact bounce time	< 3ms
Contact closing time	< 4ms
Design	Horizontal
Housing material	Sand-cast aluminum, anodized
Weight	
	Net 1,4 kg
Ambient temperature	-5 ... 80 °C
Degree of protection	IP67
Mechanical life	30 x 10 ⁶
Contact material	Silver alloy, gold flashed
Switching principle	Snap-action switching contact
Plunger spacing	12 mm
Installation position	Any
Number of switching elements	2
Number of NC contacts	2
Number of NO contacts	2
Connection	3 x M25 x 1.5
Approach speed	0,01 ... 80 m/min
Actuating element	Roller plunger ^[1]
Roller diameter	8 mm
Actuating force	min.20 N
Operating point accuracy	± 0.01 ^[2]

Electrical connection ratings

Rated thermal current I _{th}	8 A
Utilization category according to EN 60947-5-1	
	AC-15 6A 230V
	DC-13 6A 24V
	AC-12 8 A, 250 V
Short circuit protection according to IEC 60269-1	
	(Fuse) 8A gG
Rated insulation voltage U _i	250 V
Rated impulse withstand voltage U _{imp}	2,5 kV

Switching current	Min. at DC 12V min.10 mA
Connection cross-section	0,34 ... 1,5 mm ²

Miscellaneous

C number	C2050	[3]
----------	-------	-----

[1] Plain bearing

[2] The reproducible switching point accuracy refers to the axial travel of the plunger after the switching element ES 502 E has been run-in with approx. 2000 operating cycles.

[3] Additional mechanical protection of the plunger with metal perforated rail

Dimension drawing

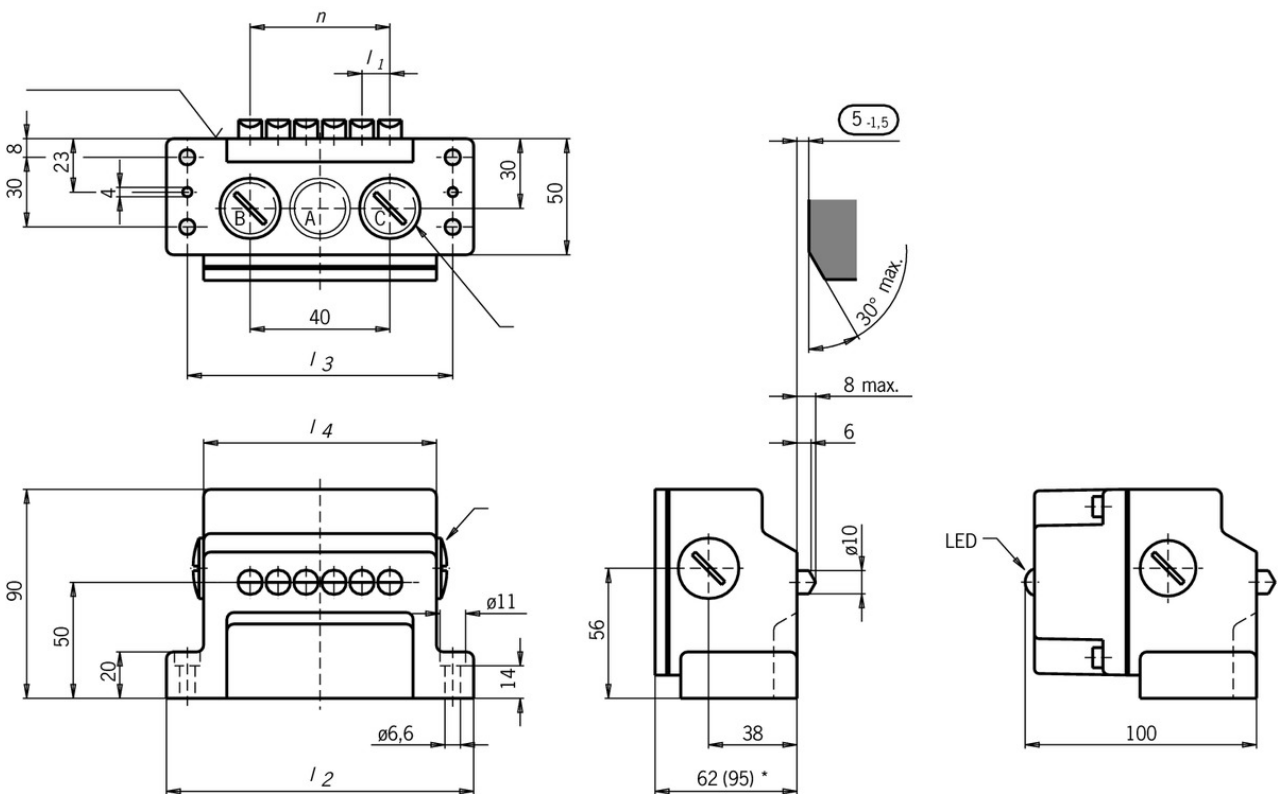

ES 502 E



ES 508

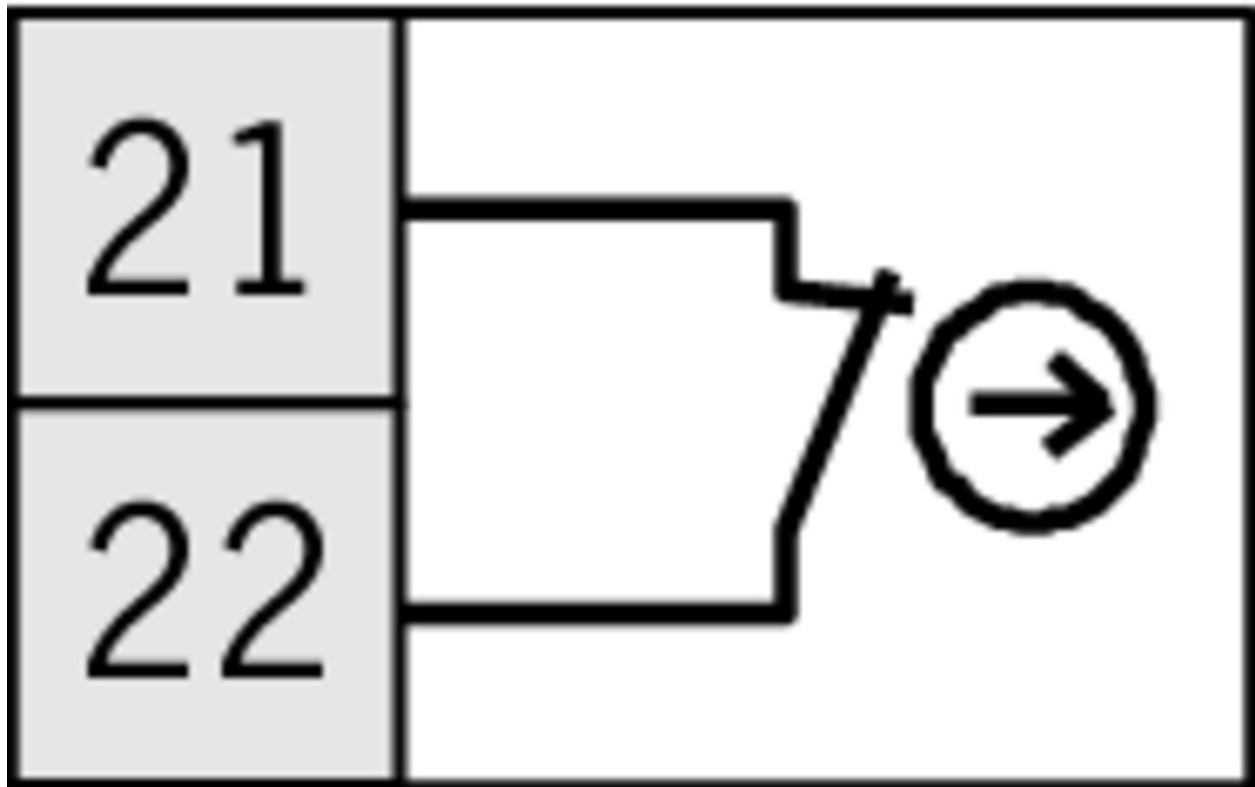



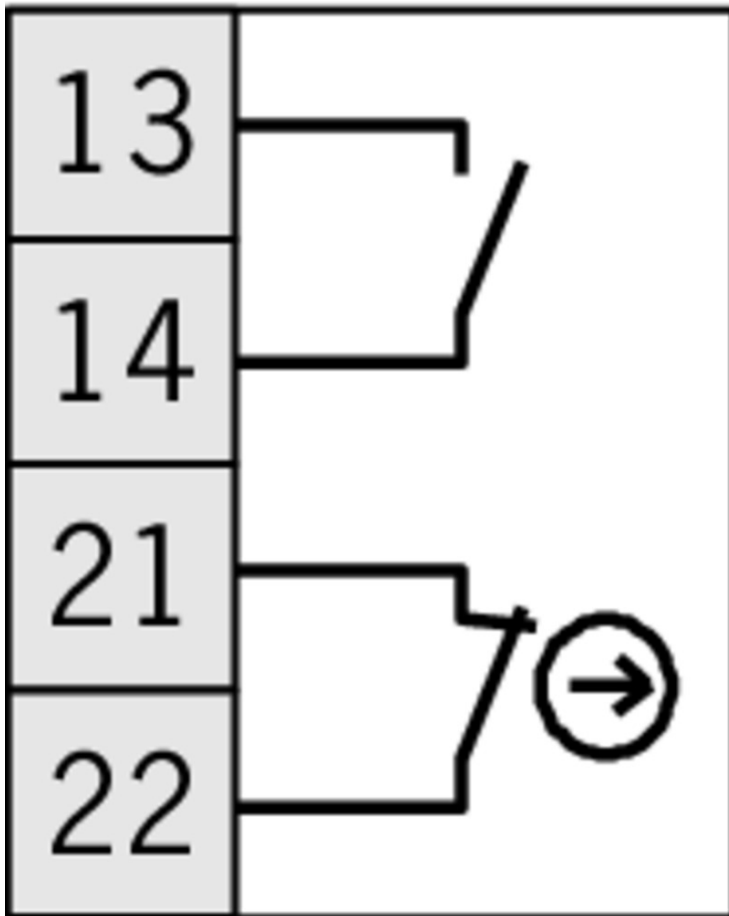

ES 514



Instructions

 Betriebsanleitung Präzisions-Reihengrenztaster RG, GS, GL 12/16 mm

	Doc. no.	Version	Language	Download
Betriebsanleitung Präzisions-Reihengrenztaster RG, GS, GL 12/16 mm	032307	07-07/16		 1.4 MB
Mode d'emploi Boîtiers multipistes de précision RG, GS, GL 12/16 mm				
Istruzioni di impiego Finecorsa multipli di precisione RG, GS, GL12/16 mm				
Operating Instructions Precision Multiple Limit Switches RG, GS, GL12/16 mm			